

Outback • Kanga



MOOMERA Maamba

Owner's Manual

DAILY CHECK LIST

BOATMAN'S CHECK LIST:

For maximum enjoyment and safety, check each of these items **BEFORE** you start your engine:

- √ **DRAIN PLUGS** (Securely in place?)
- √ **LIFE SAVING DEVICES** (One for every person on board?)
- √ **STEERING SYSTEM** (Working smoothly and properly?)
- √ **FUEL SYSTEM** (Adequate fuel? Leaks? Fumes?)
- √ **BATTERY** (Fully charged? Cable terminals clean and tight?)
- √ **ENGINE** (In neutral?)
- √ **CAPACITY PLATE** (Are you overloaded or overpowered?)
- √ **WEATHER CONDITIONS** (safe to go out?)
- √ **ELECTRICAL EQUIPMENT** (Lights, horn, pump, etc.?)
- √ **EMERGENCY GEAR** (Fire extinguisher, bailer, paddle, anchor & line, signaling device, tool kit, etc.?)
- √ **BILGE PUMP** (Working properly?)

NOTICE: Bilge pump should be checked prior to each use to insure proper operation!

CHECK BEFORE RUNNING:

1. Engine oil level.
2. Transmission lubricant level.
3. Engine drain plug, transom drain plug and center drain plug.
4. Leakage (fuel and water lines and connections).

⚠ CAUTION DO NOT operate engine without cooling water flowing through water pump otherwise pump will sustain damage and subsequent engine damage may result.

CHECK WHILE RUNNING:

1. Oil pressure: Refer to Engine Owners Manual.
2. Water temperature: 160° to 180° for raw water systems (water is not recirculated), and 180° to 200° for closed cooling systems (water is recirculated).
3. Idle RPM: (550 - 600) in gear.
4. Maximum forward RPM: See Engine Manual.
5. Shifting linkage (forward, neutral and reverse).

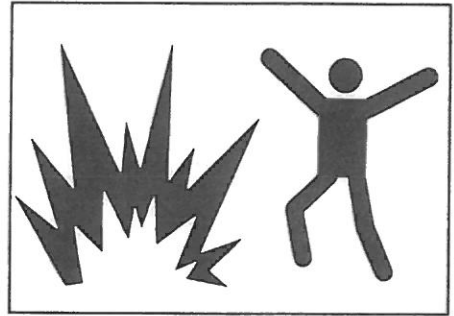

⚠ WARNING It is very important to check for fuel spillage or leaks prior to each use of your boat.

Gasoline vapors can explode!

Before starting engine:

- Check engine compartment for gasoline vapors.
- Operate blower for 4 minutes.
- Always operate blower below cruising speed.

NOTICE: Please refer to your Engine Owners Manual for maximum RPM and engine break-in procedure.

MOOMBA OWNER'S MANUAL

Moomba inboard ski boats are manufactured by Skier's Choice, Inc. in Maryville, Tennessee and distributed throughout the United States and the world.

This manual should be considered a permanent part of your Moomba boat. Should the boat be sold, the manual will provide the next owner with important information on safety, operation and maintenance.

All information, illustrations and specifications in this manual are based on the latest product information available at the time of printing. Since information is included for all Moomba models, some items may not apply to your boat since it will not have the same equipment available on other models.

Skier's Choice, Inc. reserves the right to make changes at any time without notice. A maintenance schedule and accessory information are included to assure trouble-free operation of your boat. Should service problems arise, remember that your Moomba dealer knows your boat best and is interested in your total satisfaction.

TABLE OF CONTENTS

SPECIFICATIONS.....	3
TRAILER & TOWING	8
OPERATING INFORMATION	12
INSTRUMENT PANEL AND CONTROLS	20
EQUIPMENT & OPTIONS	27
SERVICE & MAINTENANCE	36
TECHNICAL INFORMATION	46
WARRANTY	49
CUSTOMER ASSISTANCE	52
INDEX	53

OUTBACK SPECIFICATIONS

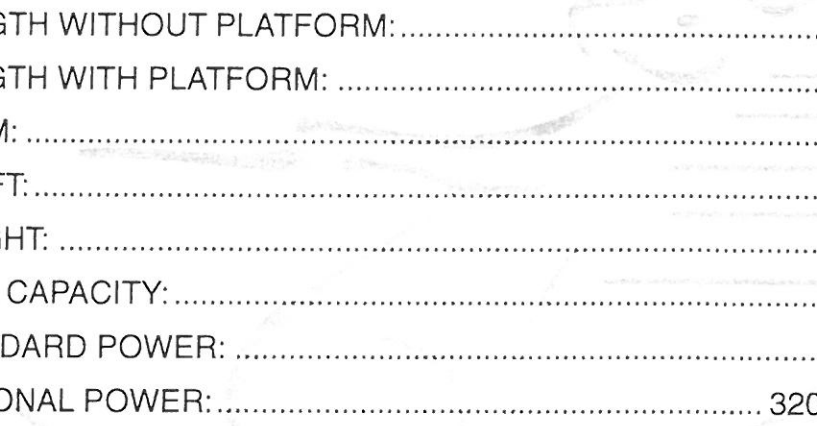

LENGTH WITHOUT PLATFORM: 20'-6"
LENGTH WITH PLATFORM: 22'-0"
BEAM: 7'-8"
DRAFT: 22"
WEIGHT: 2450 lbs.
FUEL CAPACITY: 27 gal.
STANDARD POWER: 310 hp
OPTIONAL POWER: 320 to 330 hp

OUTBACK

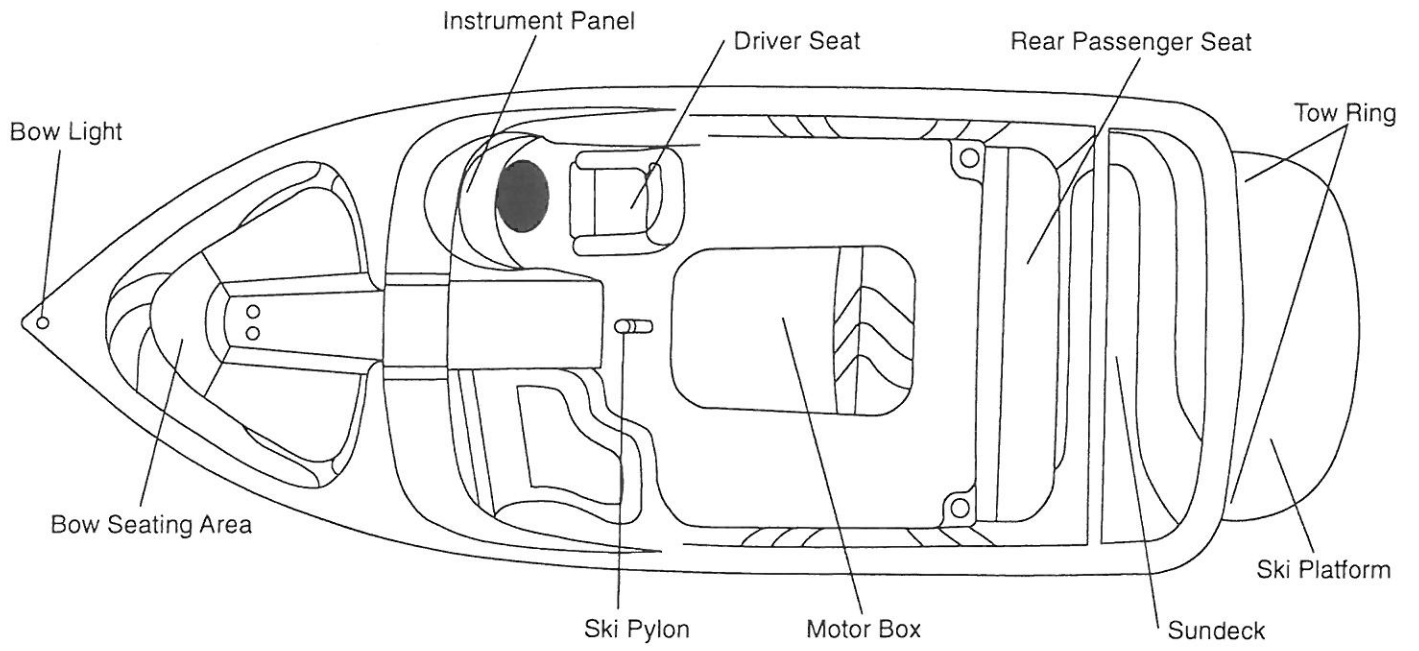

KANGA SPECIFICATIONS

LENGTH WITHOUT PLATFORM: 20'-6"
LENGTH WITH PLATFORM: 22'-0"
BEAM: 7'-8"
DRAFT: 22"
WEIGHT: 2450 lbs.
FUEL CAPACITY: 27 gal.
STANDARD POWER: 310 hp
OPTIONAL POWER: 320 to 330 hp

KANGA

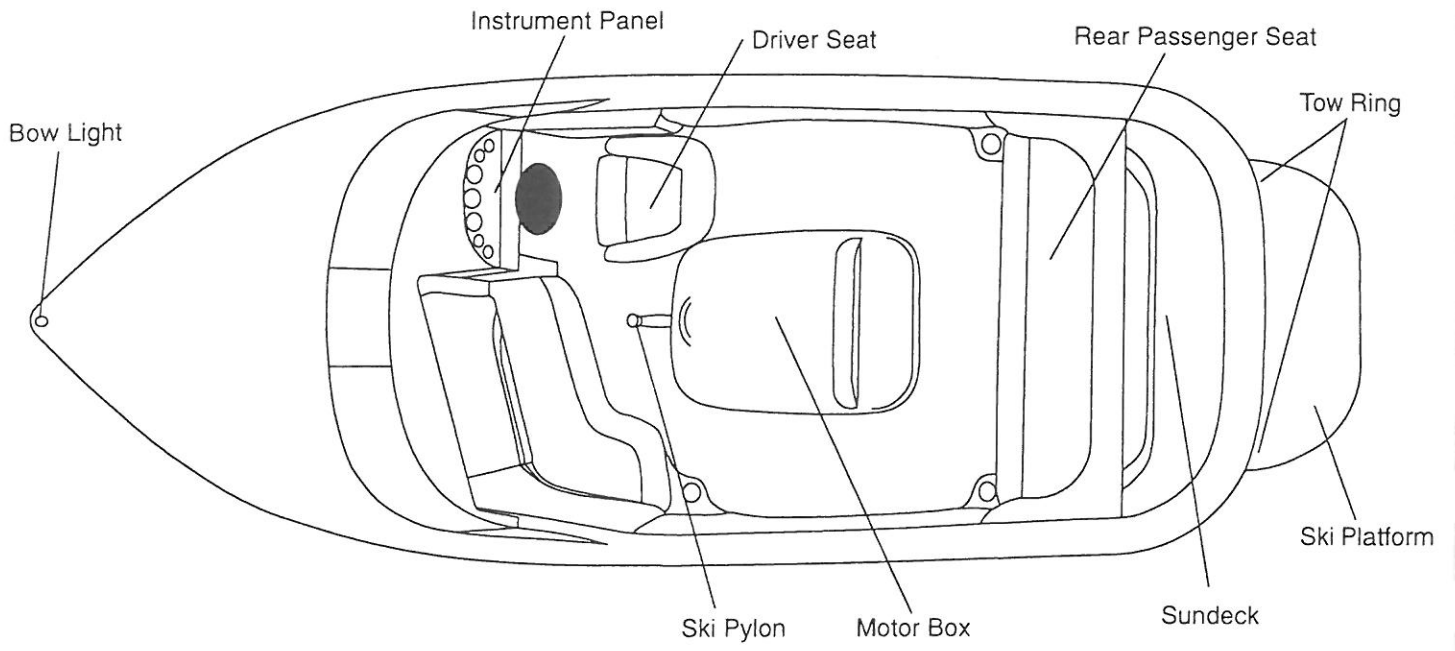

TRAILER & TOWING

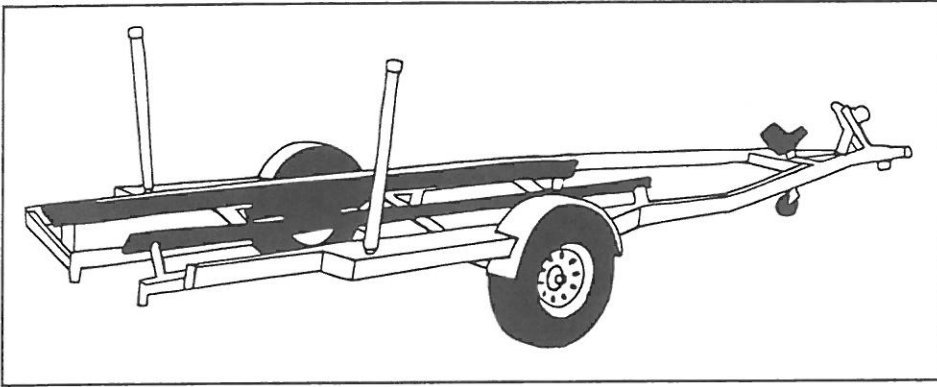

The trailer supplied with your Moomba model was designed especially for the boat with your convenience in mind. Please be sure that you have an appropriate tow vehicle before attempting to trailer your boat. Your vehicle must be capable of towing 3,500 lbs. and must be fitted with no less than a Class II (3,500 lb. max.) trailer hitch, however, a class III is preferred.

CAUTION Read the trailer towing section of your vehicle owner's manual before towing your trailer.

All Moomba trailers require a 2" ball and a five (5) pin marine grade trailer wiring connector. The standard height from the ground to the top of the hitch ball should be about 20 inches. With the trailer attached to the tow vehicle, the trailer should stand approximately level.

Trailer Plug Wire Schematic

White: Ground
Green: Right Turn / Brake
Yellow: Left Turn / Brake
Brown: Running Lights
Blue: Reverse Lights

NOTE: Moomba trailers feature disk brakes. The fifth wire (blue) on the wire connector needs to be connected to your vehicles reverse lights to be operative. This wire (blue) provides power to a solenoid which deactivates the brakes while in reverse. You may still tow your trailer without the blue wire connected, however, you may experience difficulty backing the trailer.

CONNECTING THE TRAILER

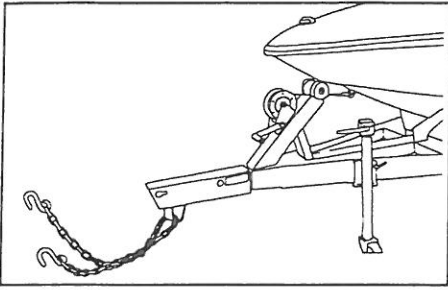

When connecting the trailer to your tow vehicle use the following procedure:

1. Raise the tongue with the trailer jack, position the trailer tongue directly over the 2" ball, and lower the jack until the tongue goes all the way down over the ball.
2. Press down on the latch until it locks on the ball with a "click."
NOTICE: If your hitch ball has an excessive flat spot on top, the latch may not engage properly. If the latch does not catch, check with your dealer or hitch installer before trailering.
3. Insert the locking pin into the tongue. (Lock pin hole is on the top of the tongue on trailer models without brakes, and on the side of the tongue on models with brakes.)

4. When all weight is off the trailer jack, pull the jack lock pin and rotate the jack to the horizontal position and re-lock the pin.
5. Attach the safety chains to the tow vehicle hitch. Cross the chains and wrap them around each other once or possibly twice allowing just enough slack to permit tight turns of the vehicle and trailer.
6. Plug the trailer lights connector to the vehicle harness.
7. Clip the brake lock-out cable to the vehicle hitch.

TRAILER & TOWING

⚠ WARNING BEFORE USE, READ ALL INFORMATION SUPPLIED WITH THE TRAILER BY THE MANUFACTURER.

The following guidelines will prolong the life of the boat and trailer:

1. Always secure the boat to the trailer with tie-downs. Do not place straps around fenders or lights.
2. Always verify that the winch hook is securely in the bow eye, the strap is tight and the winch handle locked in place before trailering.
3. Check the recommended pressure displayed on the side of the tires and assure that it is maintained. Under-inflated tires could cause trailer sway and excessive tire wear.
4. Verify that the trailer hitch on the tow vehicle is the proper class and size to support the tongue weight and the trailer load.
5. Check wheel bearing grease (Bearing Buddy.)

UNLOADING PROCEDURE

To unload the boat use the following procedure as a guide:

1. Make sure that all drain plugs are securely in place.
2. Unplug light cord before backing into the water.
3. With Bow Eye Hook fastened, back the trailer until the water level is approximately 1 inch below the top of the trailer fenders.

NOTE: Ramp slopes vary, so actual level of water on trailer may be different.

WARNING Make sure that the engine water intake is fully submerged.

4. Follow the cold start procedure recommended in this manual.
5. With engine idling, center the steering wheel, engage the transmission into reverse (pull back on lever,) then ease back on the throttle.

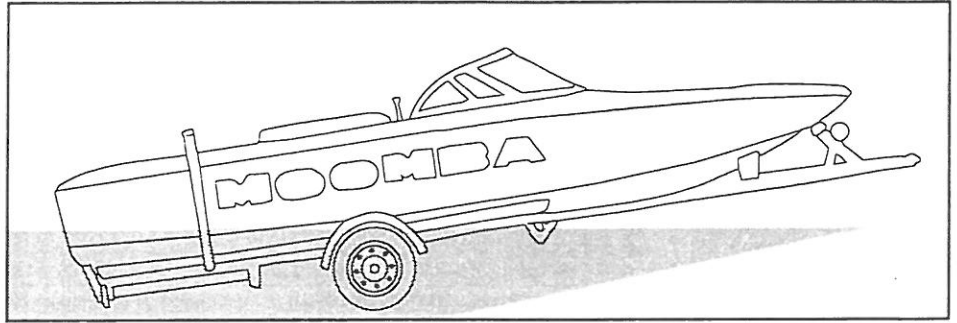

NOTICE: DO NOT attempt to use excessive power to free the boat from dry carpet runners. Power off of the trailer only when the boat has floated free.

WARNING If the trailer is not submerged to the correct depth, the bow of the boat could drop when powering off incorrectly, possibly damaging the boat.

NOTE: Because your Moomba is a direct drive inboard, when backing the stern will have a tendency to drift left or right depending on propeller rotation. This condition will self-correct as the rudder reaches control speed.

NOTICE: Before operating your Moomba refer to the Daily Check List and the BOATMAN'S CHECK LIST.

LOADING PROCEDURE

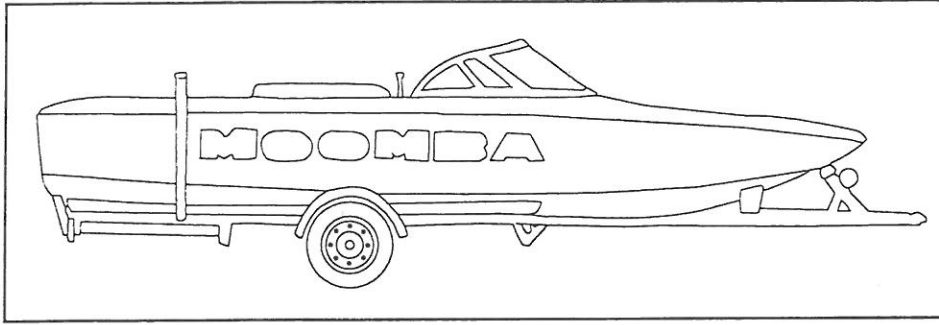

To re-trailer the boat, position the trailer in the water with approximately 1 inch of the top of the fender showing as in step 3. UNLOADING.) Idle/coast the boat onto the trailer using as little power as possible keeping it centered between the guide poles.

DO NOT Power onto the trailer during rough conditions.

When correctly positioned on the trailer turn off ignition.

Use the Hook and Trailer Winch to pull the boat up to the Roller Stop.

BOAT HOOKUP

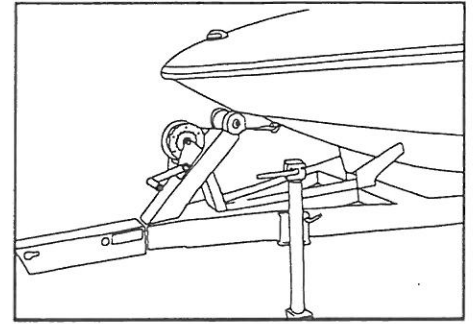

It is important that the boat is securely in place before moving the trailer from the water.

- Secure trailer hook to bow eye and tighten winch firmly.
- Check winch lock for secure placement.

TRAILER ALIGNMENT

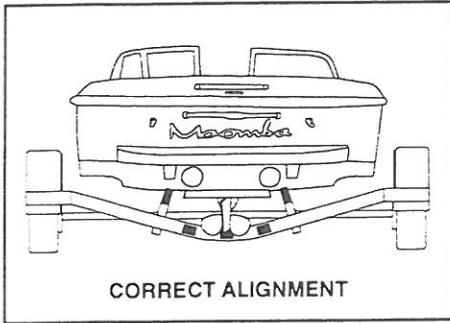

When pulling the boat onto the trailer, be sure that it is centered on the trailer.

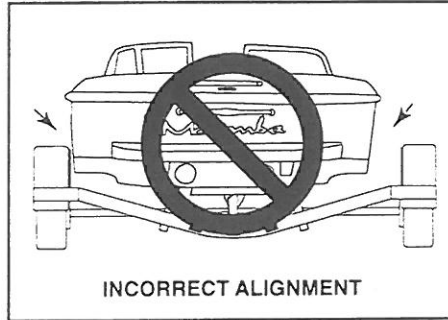

The distance between the boat and the wheel runner board should be about equal on both sides.

OPERATING INFORMATION

MAXIMUM CAPACITIES



In compliance with United States Coast Guard Regulations, Supra Boats meet or exceed all safety standards designed for recreational boats. To insure safe handling and performance, each Supra boat displays a maximum capacity sticker (see sample), stating the maximum passenger weight load allowable.

NOTICE: Refer to the Maximum Capacity Sticker on your boat for allowable loading.

COAST GUARD REGULATIONS

The United States Coast Guard boating regulations prescribe minimum standards of safety to be met and maintained by all watercraft. It is necessary that your boat remain in compliance with these regulations.

The staff at Skier's Choice, Inc. recommend that all boat operators complete a Coast Guard approved boating safety course.

SAFETY EQUIPMENT

The following equipment should be on board your boat at all times:

- An approved hand-held fire extinguisher (furnished with your Moomba.)
- At least one USCG approved personal flotation device (PFD) for each person on board.
- At least one USCG approved throwable device (ring buoy or buoyant cushion.)
- One hand-, mouth-, or power-operated whistle or horn audible for at least one mile.
- Signal flares should be carried by boats operating offshore.
- Additionally it is recommended that you carry an anchor with 100 feet of anchor line, tie-up lines, boat fenders (bumpers), first-aid kit, emergency tool kit, waterproof flashlight, distress flares, a large sponge, electrical tape, and duct tape.

STARTING

A standard pre-starting procedure should always be followed before the first startup of the day.

1. Check oil in engine.
2. Check for gasoline fumes in bilge or engine compartment.
3. Operate engine blower for 4 minutes to remove any fumes.
4. Check manual operation of bilge pump, make sure bilges are empty.

Other items might also be inspected, depending on the boat and its use. It is advisable to formulate a check list particular to the equipment and operation of your boat.

REFER TO THE BOATMAN'S CHECK LIST LOCATED ON THE INSIDE COVER OF THIS MANUAL. Consult the local Coast Guard Auxiliary or Power Squadron for full details on boating safety.

TO START ELECTRONIC FUEL INJECTION (EFI) ENGINE

1. Place shift selector in Neutral with the throttle in the upright (zero) position. (If throttle is not in the idle position, the throttle position sensor will not allow the engine computer to proceed with a normal starting procedure.)
2. Turn Ignition Key to Start Position to operate the starter.
3. Release the Key when engine starts (key will return to run position.)
4. Allow the engine to establish a good idle (30 to 60 seconds) before getting underway.
5. Shift slowly into forward or reverse, allowing the transmission time to engage before powering up.

NOTE: It is normal for the idle to speed up in cold start conditions.

WARNING DO NOT continue to operate the starter for more than 15 seconds at a time without pausing to allow the starter motor to cool down for at least one minute. This will also allow the battery to recover between starting attempts. (Refer to engine manual.)

NOTE: Should the EFI engine become "flooded" use the following procedure to start:

- 1F. Place shift selector in Neutral and disengage the transmission by pushing the transmission lock-out button located at the bottom of the lever.
- 2F. With the transmission disengaged push the lever forward to full throttle position. (This will cause the computer to shut off the fuel injectors which will allow the engine to clear of excess fuel during starting.)
- 3F. Turn the Ignition Key to Start Position and operate the starter for no more than 15 seconds at a time until the engine starts.
- 4F. When the engine starts, back off the throttle and allow the engine to establish a good idle (30 to 60 seconds.)
- 5F. Return the throttle to idle position and the transmission lockout will automatically re-engage the transmission in neutral position.
- 6F. When ready to get underway, shift slowly into forward or reverse, allowing the transmission time to engage the gearing before powering up.

TO START A CARBURETOR ENGINE

1. Place shift selector in neutral with the throttle in the upright (zero) position and push the transmission lock-out button at the bottom of the lever to disengage the transmission.
2. Turn the ignition key to the start position to operate the starter.
3. When the engine starts, release the key and it will return to the run position.
4. With the transmission disengaged, push the throttle lever forward to increase the engine idle to 1200 to 1500 RPM.
5. When the engine idle smooths out, return the throttle to idle position and the transmission lockout will automatically re-engage the transmission in neutral position.
6. When ready to get underway, shift slowly into forward or reverse, allowing the transmission time to engage the gearing before powering up.

IF CARBURETOR ENGINE DOES NOT START

- 1B. Place shift selector in neutral with the throttle in the upright (zero) position and push the transmission lock-out button at the bottom of the lever to disengage the transmission.
- 2B. With the transmission disengaged, push the throttle lever forward about one-fourth (to slow run position.)
- 3B. Turn ignition key to Start Position to operate starter.
- 4B. When the engine starts operate the throttle lever to establish an engine idle of 1200 to 1500 RPM.
- 5B. When the engine idle smooths out, return the throttle to idle position and the transmission lockout will automatically re-engage the transmission in neutral position.
- 6B. When ready to get underway, shift slowly into forward or reverse, allowing the transmission time to engage the gearing before powering up.

IF CARBURETOR ENGINE FAILS TO START

- 1C. Place shift selector in neutral with the throttle in the upright (zero) position and push the transmission lock-out button at the bottom of the lever to disengage the transmission.
- 2C. With the transmission disengaged, move the throttle lever back and forth from one-fourth to one-third throttle.
- 3C. While moving the throttle lever turn the ignition key to Start Position to operate the starter.

NOTE: Do not operate the starter for more than 15 seconds at a time. Allow the starter to rest for a full minute before attempting this starting procedure again.

- 4C. When the engine starts, operate the throttle lever to establish an engine idle of 1200 to 1500 RPM.

IF CARBURETOR ENGINE FLOODS

- 1F. Place shift selector in neutral with the throttle in the upright (zero) position and push the transmission lock-out button at the bottom of the lever to disengage the transmission.
- 2F. Push the throttle lever to the full forward (wide open) position.
- 3F. Turn Ignition Key to operate starter.

NOTE: Do not operate the starter for more than 15 seconds at a time. Allow the starter to rest for a full minute before attempting to start again.

- 4F. When engine starts, back off the throttle, but allow the engine to idle at 1500 RPM until it smooths out.

THROTTLE LEVER

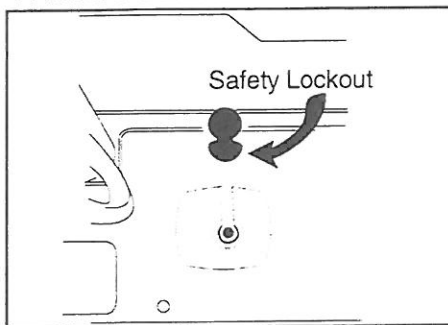

The throttle lever controls both the throttle and the transmission. The idle position (normally vertical) is the zero throttle position and the neutral position for the transmission. A safety ring keeps the lever from being accidentally moved to engage the transmission.

To place the transmission into gear, with your hand placed over the lever ball, pull up on the safety ring and slowly push the lever into forward gear or slowly pull the lever back into reverse gear.

CAUTION Never shift the lever directly from the neutral (vertical) position into a speed position.

- To prevent damage to the transmission always allow the transmission time to engage before accelerating the engine.
- Once the transmission is engaged, you may accelerate as quickly as you like.

TRANSMISSION LOCK OUT

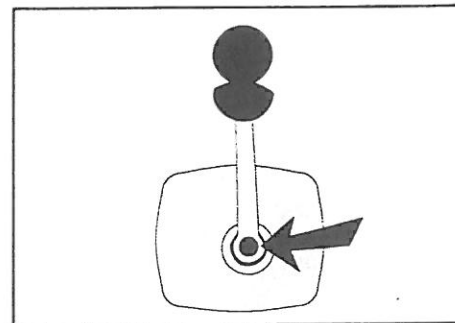

The Transmission Lockout button allows the transmission to be disengaged while giving the throttle full operating range. With the lever in the idle position (normally vertical) push the button located at the bottom of the lever to disengage the transmission. The throttle may then be operated in any open position (forward of neutral or back of neutral upright position.) Return the throttle to idle position, and the transmission lockout will automatically re-engage the transmission in neutral position.

ENGINE BREAK-IN

The engine in your new Moomba will last longer and run better if you follow some simple procedures during the first few hours of use.

- Let the engine warm up gradually.
- Avoid running the engine at high speed.
- Don't carry a heavy load (passengers or gear).
- Vary your boat speed during break-in; don't run at the same RPM for more than a half-hour.
- Avoid fast accelerations, and don't pull a heavy load during break-in.

BREAK-IN STEPS

- For the first hour of operation, do not exceed 2000 RPM.
- For the second hour, do not exceed 3000 RPM. Carry only a light load and vary your speed.
- For the third through seventh hours, do not exceed 4000 RPM. Carry only modest load and vary your speed.

BREAK-IN TIPS

- Always let the engine warm up gradually and thoroughly before accelerating.
- Check the oil often. During the first 50 to 100 hours an engine can use more oil than usual. Maintain oil at proper level and do not over-fill.

- Check the transmission fluid level.
- Monitor the engine temperature during break-in. Should overheating occur immediately reduce speed. If overheating persists, notify your dealer.
- Watch for any loose mountings, fittings, nuts, bolts and clamps.
- Report any unusual noises or vibrations to your dealer.
- Monitor the gauges and warning lights and report anything unusual to your dealer.

After the first 10 to 20 hours of operation, take your boat to the dealer for its first oil and filter change and engine check-up.

When the break-in procedure is completed, the engine may be operated continuously at any speed.

CAUTION Do not exceed maximum RPM recommended for your engine. Exceeding the maximum RPM may damage the engine. See engine manual.

BILGE AREA DRAIN PLUG

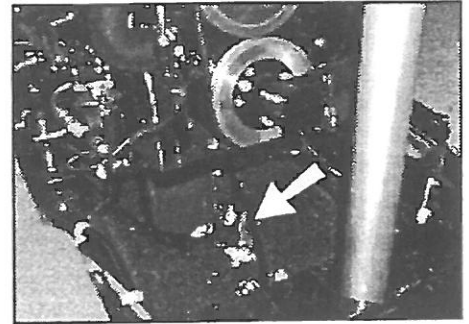

The bilge area drain plug is located at the front of the motor well, in the center under the engine.

It is extremely important that the drain plug is always checked before starting the engine. The drain plug should be secured in place using a wrench.

WARNING DO NOT start engine until center drain plug is checked and secured in place. DO NOT try to install center drain plug while engine is running.

FUEL INFORMATION



Use a gasoline with a minimum octane rating of 89.

Gasoline containing additives, stabilizers and detergent is acceptable.

⚠ WARNING DO NOT use gasoline containing methyl alcohol (methanol) or ethyl alcohol (ethanol). Methanol and Ethanol can damage your boat's fuel system.

Gasoline Stabilizer should be added to the fuel tank when the boat is used infrequently or whenever your boat will not be used for two weeks or more. During storage always add Gasoline Stabilizer to reduce gumming or tank sludge.

FILLING THE FUEL TANK

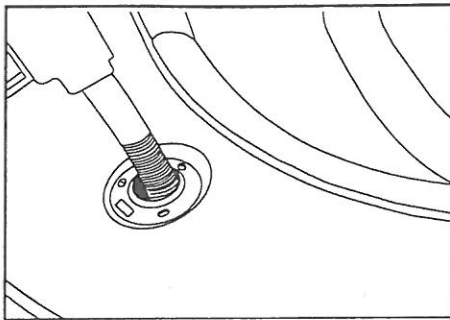

⚠ CAUTION Be especially careful when filling the fuel tank. DO NOT over fill the tank. Fuel may empty through the fuel vent and damage to finishes could result.

If fuel is spilled on stripes or decals, apply a common bath cleaner (non-abrasive) and wipe with a damp cloth. Rinse the spill area with clean water.

FUEL PRECAUTIONS

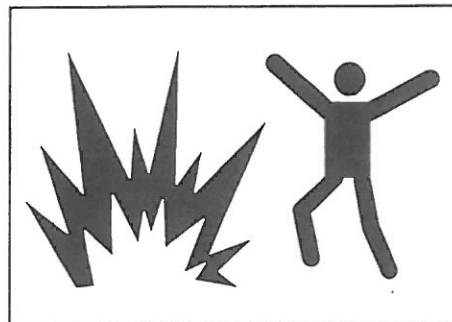

⚠ WARNING Sparks while fueling could cause an explosion!

BEFORE FUELING:

1. Turn off engine.
2. Turn off ignition.
3. Extinguish cigarettes or any open flame.

WHILE FUELING:

1. Keep hose nozzle in contact with fill pipe to provide a ground against static sparks.
2. Fill tank at a slow rate to avoid any spillage.

FUELING

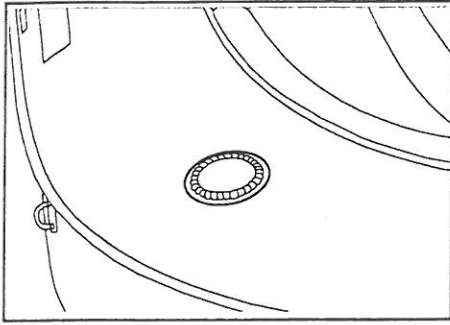

The fuel cap is located on the starboard deck near the stern. A special fuel key is provided to open the cap.

NOTE: The cap is sealed by a rubber O-ring. Please do not over tighten.

FUEL GAUGE

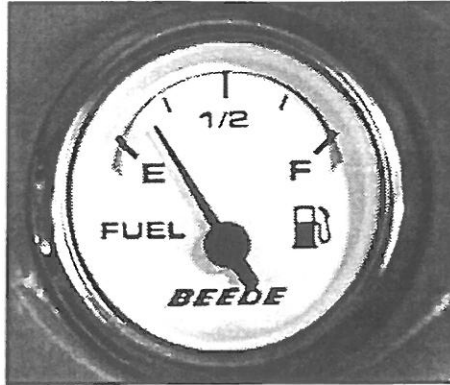

This gauge indicates the approximate quantity of fuel remaining in the tank when the ignition is in the "ON" position.

NOTICE: DO NOT run the tank to empty. To prevent condensation from forming in the tank, it is recommended that the tank be filled when the gauge indicates 1/4 tank.

DO NOT overfill tank or fuel will exit out the vent.

The following conditions may be considered normal operation of the fuel gauge and fuel system:

- Gas station pumps may shut off before the fuel gauge indicates FULL.
- The amount of fuel required for fill-up may not exactly correspond to the gauge.
- The gauge needle may not move away from FULL until some time after fill-up.
- The gauge needle may move during turns, stops, and acceleration.

NOTICE: Become familiar with engine hourly fuel consumption at various speeds and know when to check the fuel gauge.

OIL LEVEL CHECK

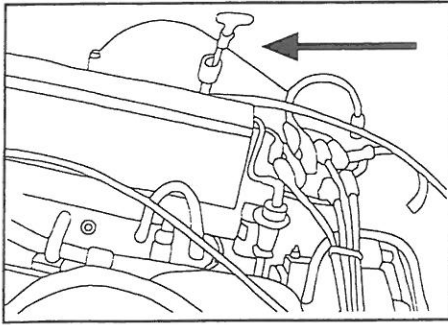

Engine oil level should be checked at regular intervals (such as every 5 engine hours.) To obtain a true reading, when the engine is at operating temperature and turned off, check the oil level showing on the dipstick.

If the oil level is between the "FULL" and the "ADD" marks on the dipstick, simply replace the dipstick. When the oil level is at or below the "ADD" mark, add oil to return the level to the "FULL" mark.

DIPSTICK

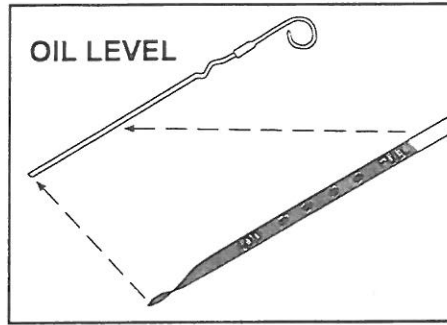

If the oil pressure indication is too high or too low, stop the engine immediately and check the oil level on the dipstick.

NOTICE: The oil pressure varies with engine temperature and speed. If oil pressure does not increase when throttle is increased, shut off the engine immediately. Continued operation while oil level is incorrect or without pressure may result in serious engine damage. Report any problem to your dealer as soon as possible, and do not operate engine until corrected.

ENGINE OIL

The engine crankcase oil should be selected to deliver the highest performance for your operating conditions and climate. In general engine oils with lower viscosity ratings are used when outdoor temperature remains low. Oils with higher viscosity are used when outdoor temperature is warmer and when higher performance is expected from the engine.

Indmar recommends 15W-40 Pennzoil Marine in their engines. If not available, for general use in summer conditions, 20W-50 high grade automotive oil with an A.P.I. classification of "SE" is recommended. Synthetic oils are not recommended until after the engine has been run for 100 hours.

Refer to Engine Manual for more information. For filter and capacity information, see the Engine Data table in this manual.

INSTRUMENT PANEL AND CONTROLS - OUTBACK / KANGA

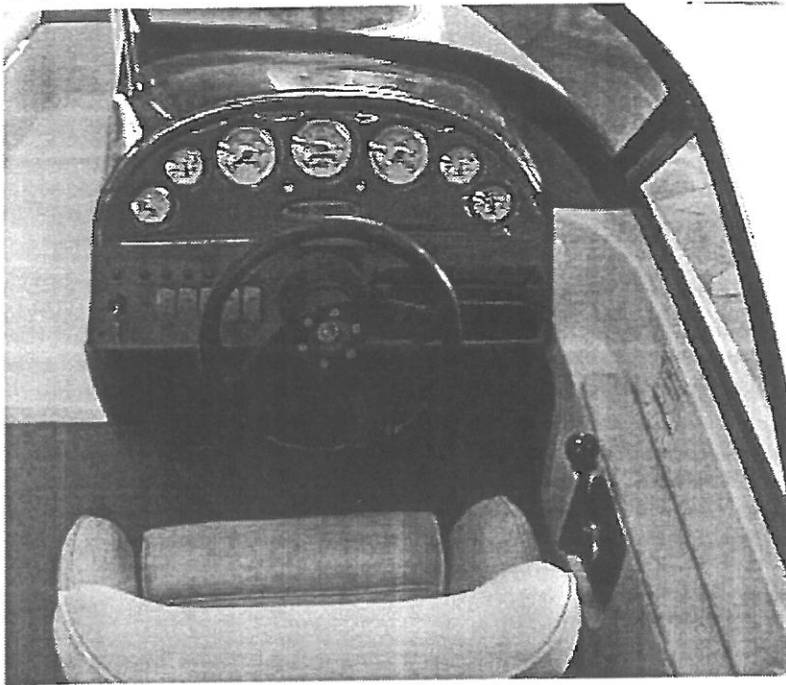

SPEED CALIBRATION

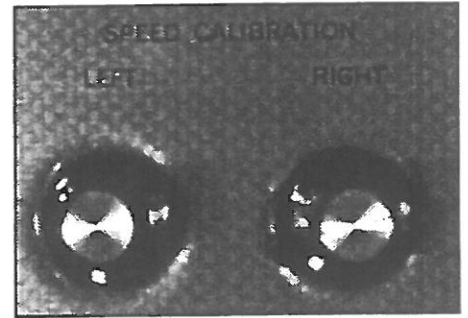

Speed may be checked using a stopwatch and a standard slalom course. Adjust the speedometer needle by twisting the adjuster buttons.

SLALOM COURSE SPEEDS:

MPH	SECONDS	ALLOWABLE
+ or - 1/2 MPH		TIMES / (SECS)
18	32.19	32.0 - 32.6
20	28.97	28.0 - 28.6
30	19.31	19.0 - 19.6
32	18.11	17.9 - 18.3
34	16.95	16.8 - 17.2
36	16.08	15.9 - 16.3

WARNING STICKERS

Always heed the dash mounted warning stickers.

⚠ WARNING GASOLINE VAPORS CAN EXPLODE

BEFORE STARTING ENGINE

- CHECK ENGINE COMPARTMENT FOR GASOLINE OR VAPORS
- OPERATE BLOWER FOR 4 MINUTES
- RUN BLOWER BELOW CRUISING SPEED
- TURN OFF ENGINE BEFORE USING SWIMMING LADDER

MAKE CERTAIN THAT ENGINE IS IN NEUTRAL OR OFF BEFORE USING SWIM PLATFORM OR SUN LOUNGE

SPEEDOMETER

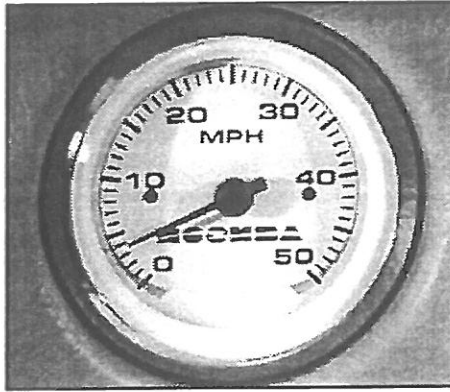

The speedometer indicates the water speed of the boat in miles per hour. It is recommended that the speedometer be checked for accuracy after each 100 engine hours.

Speed may be checked using a stopwatch and a standard slalom course. Adjust the speedometer needle by turning the knob at the bottom of the gauge.

NOTE: If speedometer registers erratically, check speedometer pickups.

SPEEDOMETER PICKUPS

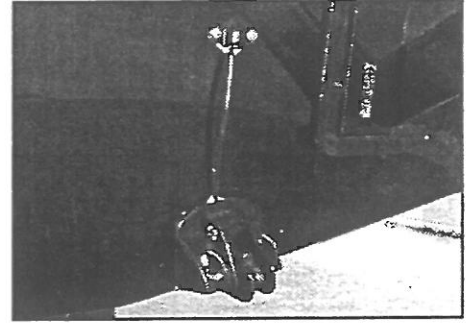

The speedometer pickups are located on the stern near the ski platform brackets. The pickups measure the speed of water passing the paddlewheel. Poor water conditions or foreign material may clog the pickup causing the speedometer to register incorrectly.

Inspect the paddlewheel and remove any foreign material.

The speedometer pickups may pivot from the down position. This could cause the speedometer to register incorrectly.

ENGINE HOURS



ENGINE HOURS are shown on the face of the TACHOMETER.

The engine hour gauge acts as an odometer for the engine. Engine hours should always be noted and documented so that required maintenance and lubricant changes may be performed at the proper intervals.

TACHOMETER

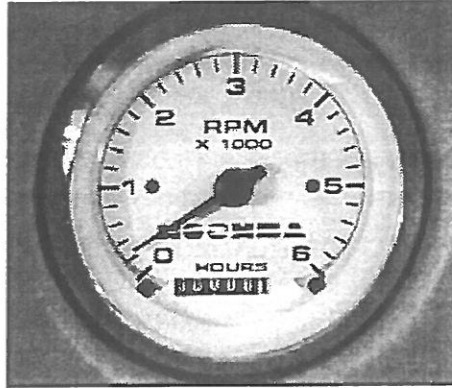

The tachometer registers the operating speed of the motor's shaft output in revolutions per minute. This output may be used as an alternative to a speedometer if weight and water conditions permit.

During tune-up and maintenance, use a dwell meter and RPM gauge to verify the dash RPM when setting your engine's idle speed.

DO NOT exceed the recommended RPM during break-in and normal operation of your motor. Exceeding the manufacturer's suggested RPM may cause damage to the engine.

IGNITION

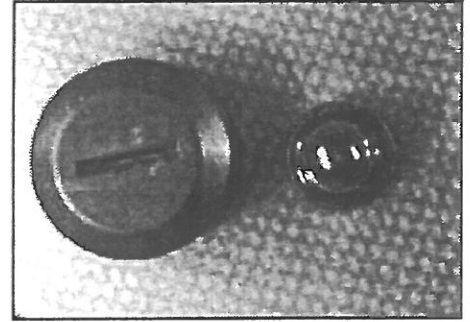

Located on the port side of the dashboard, the ignition switch has three positions. In the vertical position the ignition is OFF. With the key in, turn the ignition switch one notch to the right to check all electrical equipment, including blower, pump, and lights. Turn the ignition all the way to the right to operate the starter.

NOTICE: All electrical equipment should be turned off when the boat is in storage.

VOLTMETER

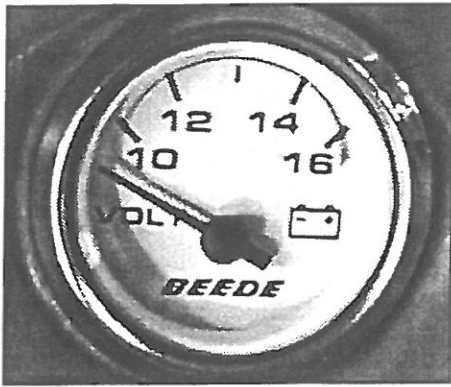

The voltmeter indicates whether the battery is charging or discharging. The needle should be located in the normal range while the engine is running.

If the voltmeter does not register in the normal range, there may be a problem within the electrical system. It is normal for the voltmeter needle to fall when starting the engine. Normal range is 12 - 14 volts.

OIL PRESSURE GAUGE

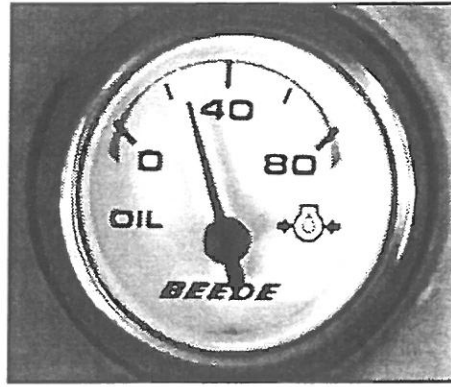

The oil pressure gauge indicates the oil pressure in the engine while the engine is running.

If the oil pressure remains below the normal range of 20 - 40 p.s.i., stop the engine immediately. If engine is allowed to run while oil pressure is low, permanent engine damage may occur.

ACCESSORY SWITCH

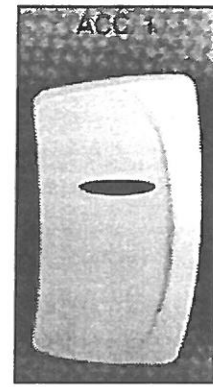

The accessory switch supplies power to an extra circuit for accessories that may be added.

NAVIGATION LIGHTS

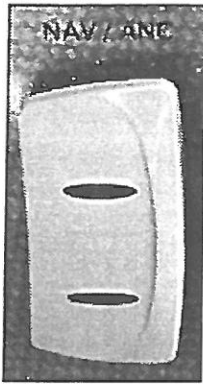

The navigation lights switch supplies power to the BOW LIGHT and the STERN POLE LIGHT.

OPERATION: When under way at night install the POLE LIGHT and set the switch in the NAV position to activate all of the running lights. When docked or at anchor at night set the switch in the ANC position to illuminate only the pole light.

NOTICE: If lights fail to operate, press the circuit breaker reset button located above or beside the lights switch.

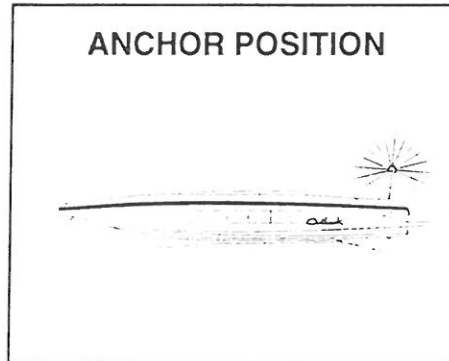
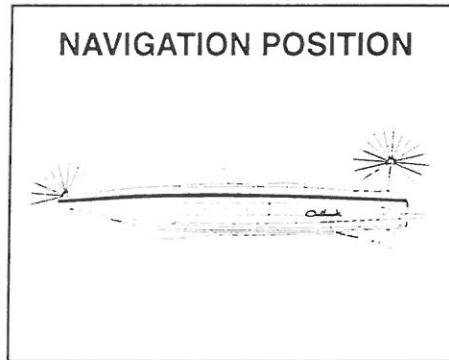

BILGE PUMP SWITCH

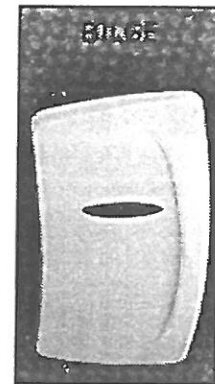

The bilge pump switch operates in two positions. The manual position is used to verify that the pump is operational. The automatic pump function is engaged at all other times so that any excess water in the bilge may automatically be pumped out.

NOTICE: If Bilge Pump fails to operate in the manual position, press the circuit breaker reset button located above or beside the switch. If bilge pump still does not operate, notify your Moomba dealer.

BLOWER SWITCH

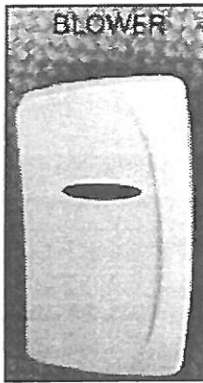

The blower switch activates the blower motor. The primary function of the blower fan is to remove any fumes from the bilge area. The blower also draws fresh air into the engine compartment.

Never depend solely on the blower to eliminate dangerous fumes. Before starting the engine always open the motor box to check if fumes are present.

Switch on the blower fan a minimum of four minutes before starting the engine.

NOTICE: If blower switch fails to operate, reset the circuit breaker located above or beside the switch. If blower still does not operate, notify your Moomba dealer.

TILT STEERING

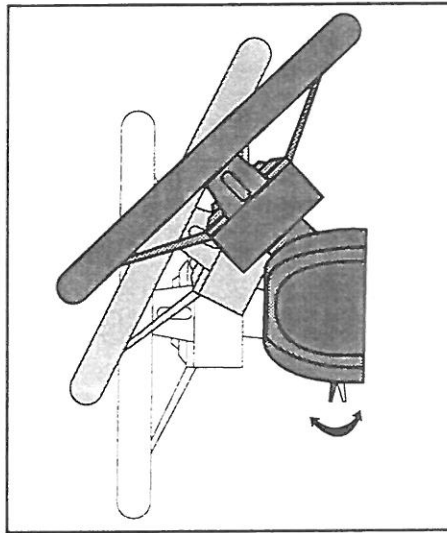

Tilt steering may be adjusted up or down in five different locking positions. To adjust, depress the tilt lever located beneath the bezel and move the steering wheel to the desired position. Release the lever to lock the wheel into place.

TEMPERATURE GAUGE

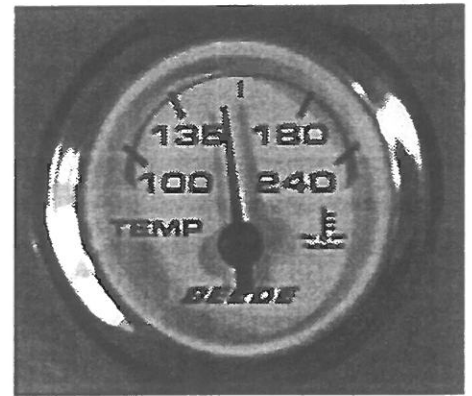

The temperature gauge indicates the engine coolant temperature while the coolant is circulating inside the engine. Engine operating temperature will vary depending on weather conditions and engine load. **SEE ENGINE MANUAL.**

If gauge reading exceeds 190°, have the cooling system checked.

WARNING Never operate the engine at temperatures above 200°.

HORN SWITCH

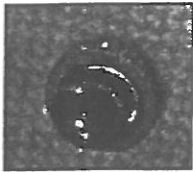

The Horn Switch is located on the port dash panel near the ignition. Sound the horn by depressing the button.

NOTICE: If horn fails to operate, press the circuit breaker reset button located above or beside the horn button.

HORN / WHISTLE SIGNALS

ONE LONG BLAST:

Warning Signal (coming out of slip)

ONE SHORT BLAST:

Pass on my Port Side.

TWO SHORT BLASTS:

Pass on my Starboard Side.

THREE SHORT BLASTS:

Engines in Reverse.

FOUR OR MORE BLASTS:

Danger Signal.

1. **OVERTAKING/PASSING:** Boat being passed has the right-of-way. KEEP CLEAR.
2. **MEETING HEAD-ON:** Keep to the right.
3. **CROSSING:** Boat on the right has the right-of-way. Slow down and permit him to pass.

BALLAST



To fill the ballast system press the fill switch. To empty, press the empty switch. With the ballast full the boat porpoise at speeds above 25 mph.

WARNING DO NOT tow boat on trailer with ballast full.

STEREO

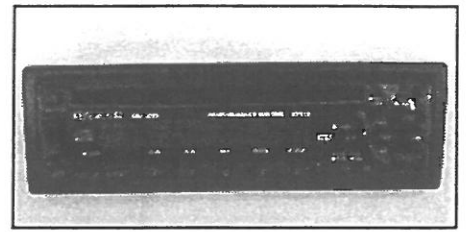

The stereo is located to the right of the steering wheel. Be sure that the stereo is completely off when done listening.

NOTICE: The face plate should be black in the off position. If the face plate says off, it is in standby mode and still drawing voltage.

EQUIPMENT AND OPTIONS

IGNITION KEYS

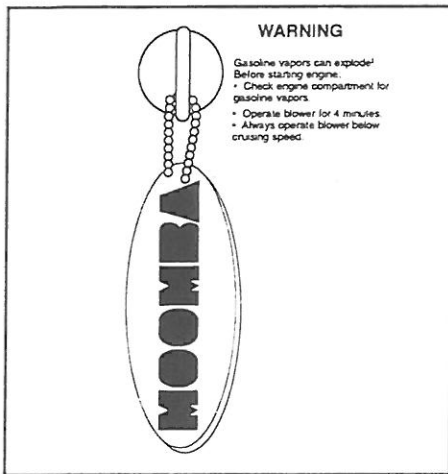

Two ignition keys are provided with the boat. Key entry into the ignition may sometimes be difficult due to the rubber boot protector. Please do not unduly force the key into the ignition. Key tumblers are located vertically, so the key should be vertical when placed into the switch.

GAS KEY

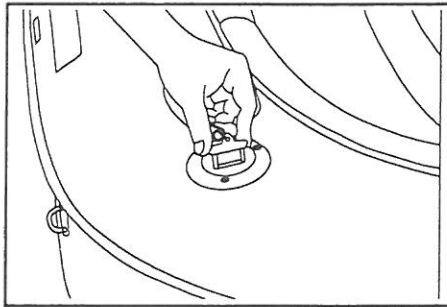

To prevent tampering with the fuel system, your boat is supplied with a gas cap which may be opened only with a special key.

NOTE: The gas cap is sealed by a rubber O-ring. Please do not over tighten.

CAUTION Always attach the ignition key and gas key to a floating key chain to prevent loss overboard.

MIRROR

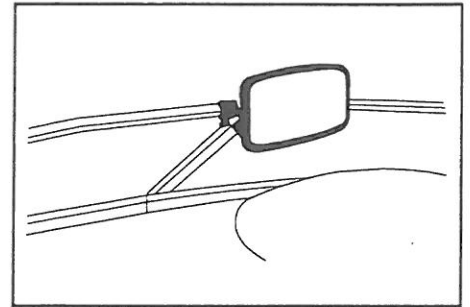

The rear view mirror is installed as a standard item. The mirror is adjustable so that it may be set for each driver.

- Mirror should always be checked before driving.
- Mirror angle will change with each new driver.

DRIVER SEAT

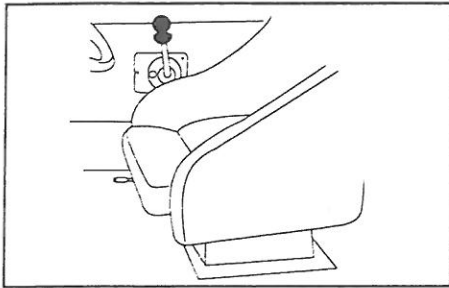

The driver seat may be adjusted forward or back by moving the lever below the front of the seat. Use body pressure to move the seat to the desired position. Release the lever, then check to feel the seat lock into place.

SEAT ADJUSTMENT

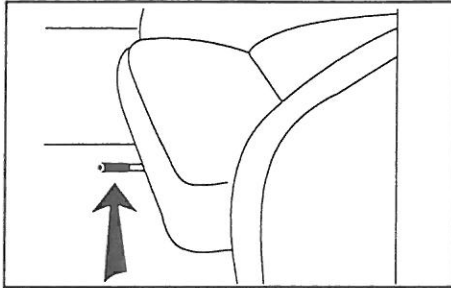

CAUTION After adjusting the seat, be sure that it has locked into place by pushing forward and back until it has securely latched.

CAUTION DO NOT attempt to adjust the driver seat while the boat is under way.

BATTERY BOX

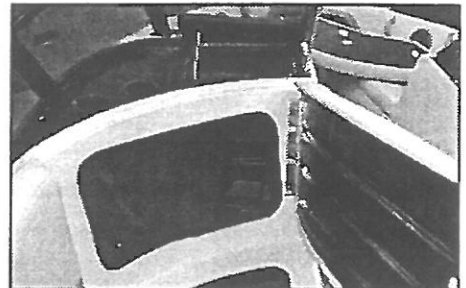

The battery box is mounted inside the observer seat storage compartment.

NOTICE: It is recommended that the battery cables be disconnected from the battery when the boat is placed in storage. (Refer to Battery Cable Installation and Precautions.)

MOTOR BOX

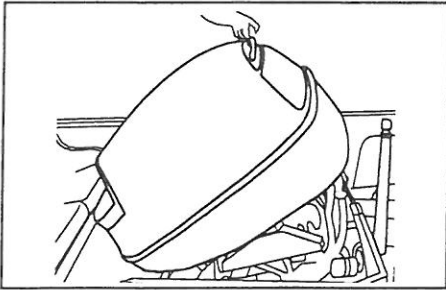

The motor box encloses the inboard engine and quiets engine noise. When opening, stand on either side, grasp the handle and pull up and back at an angle. If the engine requires maintenance, open the box lid until it rests open.

⚠ WARNING Never open the Motor Box while the boat is moving.

PULLEY & BELT WARNING

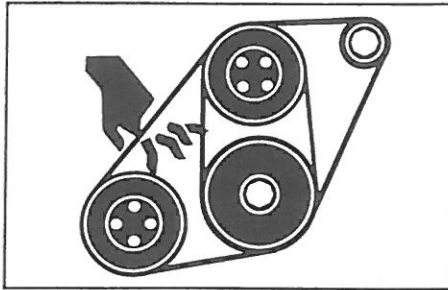

⚠ WARNING Pulleys and belts can cause severe injury. Never open the motor box while the boat is under way.

⚠ WARNING After running, the engine is hot and should not be touched or repaired until it has cooled.

BILGE AREA DRAIN PLUG

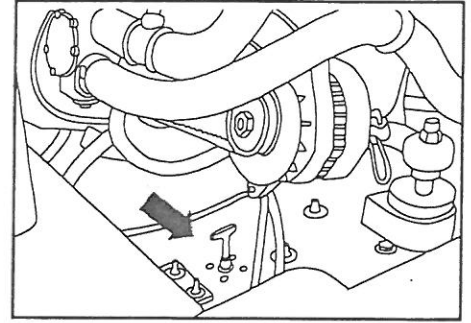

The bilge area drain plug is located at the front of the motor well, in the center under the engine.

It is extremely important that the drain plug is always checked before starting the engine. The drain plug should be secured in place using a wrench.

⚠ WARNING DO NOT start engine until center drain plug is checked and secured in place. DO NOT try to install center drain plug while engine is running.

SKI PYLON

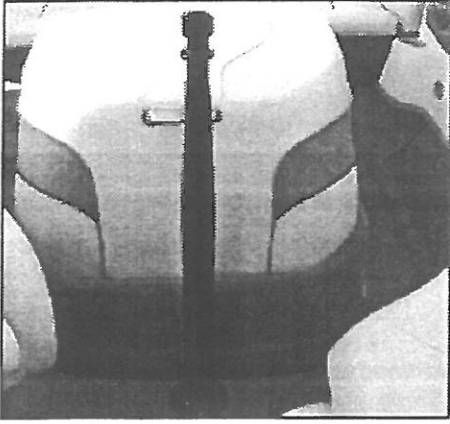

The ski pylon is only to be used to pull skiers. DO NOT use the ski pylon to hoist the boat.

NOTICE: With use the ski pylon may loosen. Should this occur, see your Moomba Dealer for service.

FIRE EXTINGUISHER

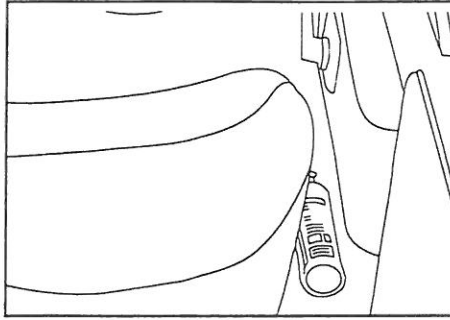

A standard Coast Guard approved fire extinguisher is provided on all Moomba boats. The fire extinguisher is located on the port side on the interior under the observer's seat.

(Refer to label instructions for use.)

RAD-A-CAGE

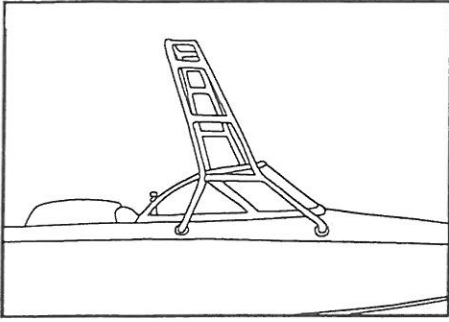

The Mobius model is equipped with a Moomba Rad-A-Cage towing tower. The cage is designed as a stable tower to enhance wakeboarding. It is **NOT** intended to be used to tow skiers, barefooters, or multiple wakeboarders. Such use will void any warranties written or implied.

CAUTION Before use, be sure that all Allen bolts are tightly in place.

WARNING Be aware of and avoid low overhead objects such as bridges, powerlines, overhanging trees, etc.

TO LOWER CAGE FOR STORAGE:

Tools required: 5/16" Allen wrench (for stainless steel 3/8-16 X 1-1/4" Allen head bolt)

- Loosen and remove the Allen head bolts that connect the rear legs to the feet.
- Place the bolts somewhere for safe storage.
- While standing in the bow area, pull the cage forward, gently placing it against the bow of the boat.

CAUTION Place padding between the cage and the boat to protect the gel coat.

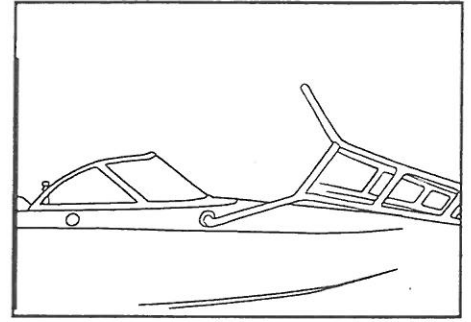

TO RAISE CAGE:

- Lift and rock the tower back into place until the rear legs align with the rear feet. (Some manipulation of the cage may be required to get the legs to line up with the feet.)
- Install and tighten bolts.

CAUTION The threads in the aluminum foot could be damaged if the bolts are not aligned and threaded correctly.

BOW LIGHT

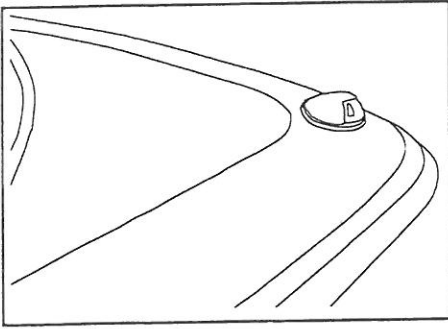

The bow light is located on the forward deck. To alert other boaters to your position and direction while underway at night, the light is green on the starboard side and red on the port side.

To replace bulb, remove phillips screw to lift cover.

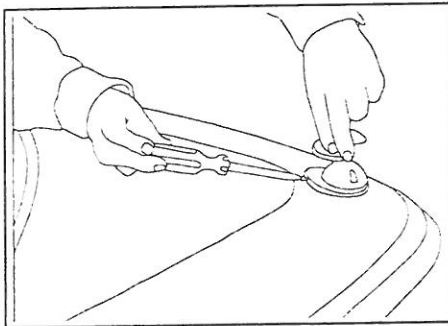

STERN POLE LIGHT

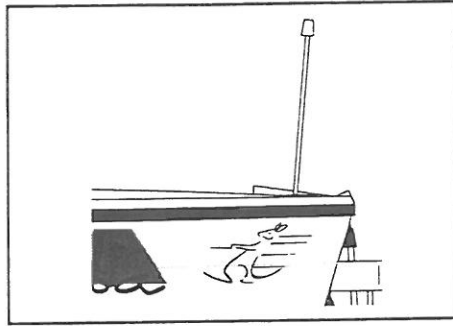

The removable pole light is stored in the bow. Always check for proper alignment when inserting the pole light into the receptacle.

The pole light must always be in place and illuminated when visibility is limited. The pole light must be displayed while under way from sunset to sunrise. The pole light must also be illuminated while at anchor from sunset to sunrise.

⚠ WARNING DO NOT pull skier with tow rope attached to ski pylon while pole light is in place.

POLE LIGHT RECEPTACLE

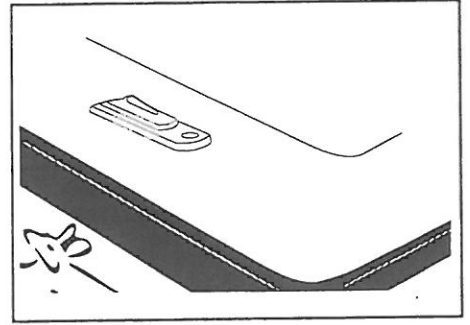

The pole light receptacle is located on the port side deck near the stern. To install the pole light, open the cover completely and with the plug correctly aligned, slide it into the socket until the electrical contacts are firmly in place.

BOW EYE

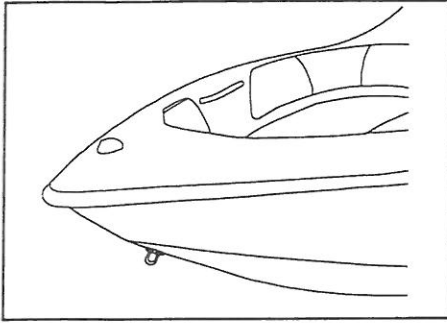

The bow eye is located at the front of the hull below the rub rail. It is the point of attachment to lead the boat onto the trailer and to secure the boat to the trailer or to a tie-off when docking.

NOTICE: See Hoisting Instructions before using the bow eye to hoist the boat.

LIFTING RINGS

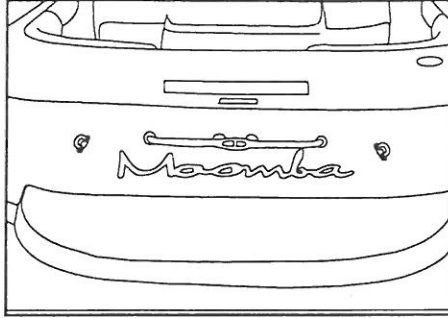

Two lifting rings are located on the transom.

NOTICE: The lifting rings should be the only point of attachment for lifting cables (See Hoisting Instructions.)

SKI PLATFORM

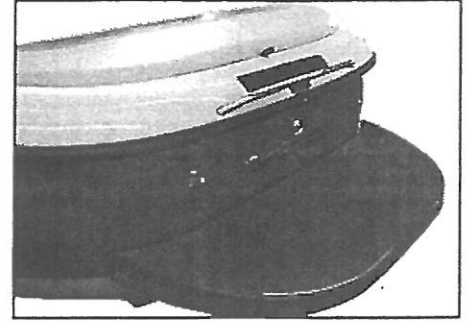

All Moomba models are equipped with a ski platform on the stern. The platform allows easy access to and from the water for skiers and swimmers.

It is recommended that all entries to and exits from the water be made from the platform to avoid accidents. (The fiberglass deck can become slippery when wet.)

WARNING Shut off the engine when people are on the platform or in the water near the platform.

DETACHABLE BRACKET

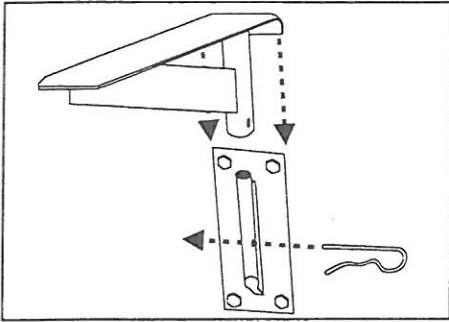

The ski platform is fastened to the boat with detachable brackets. The platform may be removed from the boat by pulling the retaining pins from the brackets.

WALK-THROUGH WINDSHIELD

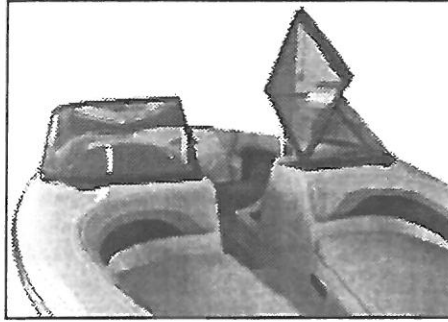

The movable center windshield panel allows access to and from the bow area on some models. To open, turn safety latches to vertical and push. Carefully lay the hinged windshield panel back against the fixed side panel.

PROPELLER

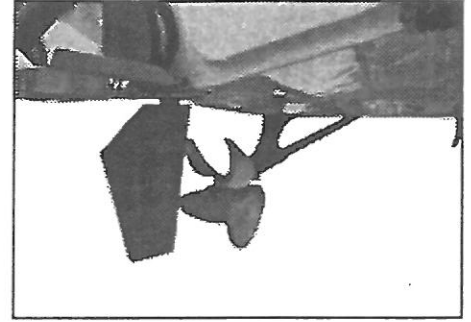

The research and design team at United Marine has carefully explored and tested many different propellers and pitch angles for use on Moomba boats. All tests indicate that the current propeller installed on your model is the best for the variety of boating performance required, whether skiing competitively or for pleasure.

It is strongly recommended that your Moomba dealer be notified before changing the propeller. In general, changing to a lower pitched propeller may increase acceleration, but will decrease top speed. Changing to a higher pitched propeller may achieve higher top speed with a light load, while acceleration and power may decrease.

PROPELLER PRECAUTION

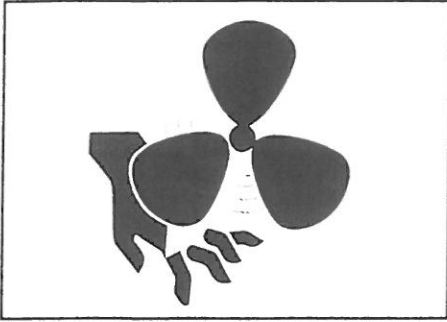

⚠ WARNING Moving propeller will cause injury. Propeller may rotate with boat in neutral. Shut off the engine when people are on the platform or in the water near the platform.

NOTICE: The maximum propeller diameter that may be used on a Moomba boat is 13".

NOTICE: Under no circumstances should a propeller which allows the engine to surpass recommended RPMs be installed.

SKI LOCKER/SUN DECK

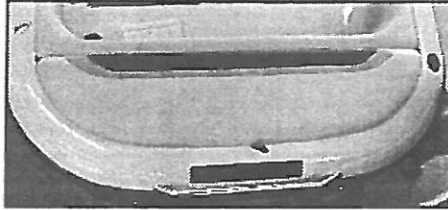

Outback and Kanga boats are equipped with a storage locker with upholstered lid which serves as a sun deck. To open, grasp the strap and pull up and forward. After storing wet gear in the locker, prop the lid open for air circulation during drying.

SERVICE & MAINTENANCE

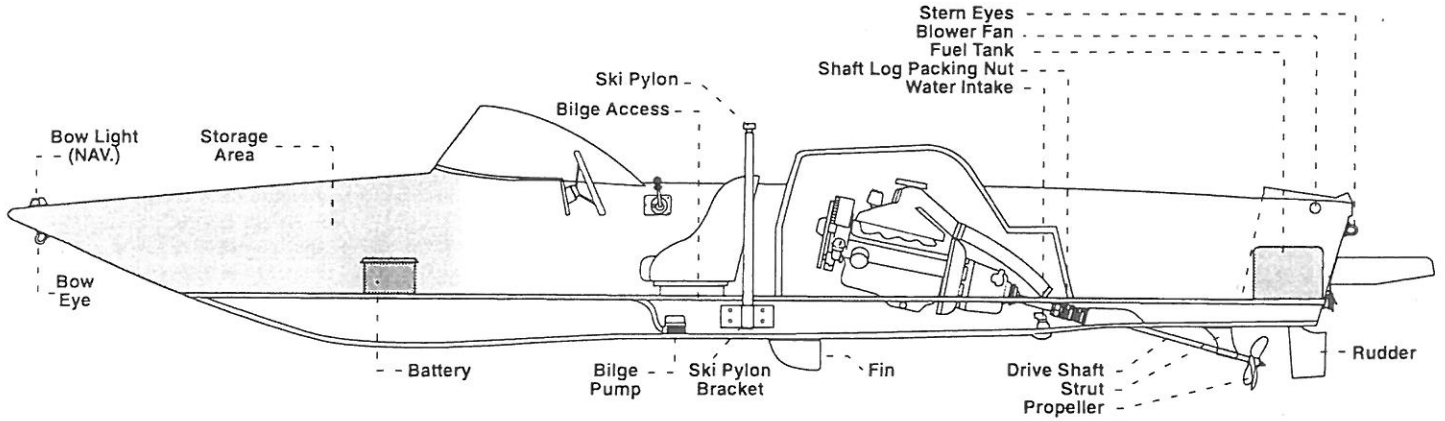

The illustration above denotes the areas which may need to be accessed or may require cleaning or maintenance. It is important to have a basic understanding of the parts and their location on the boat. However, it is recommended that any service beyond routine maintenance be performed by an authorized Moomba dealer.

MAINTENANCE

For your convenience a maintenance chart has been included in this manual. The chart indicates when to perform safety checks, lubrication, and general service to the boat. Engine hours or elapsed time determine when service is necessary.

It is recommended that any replacement parts used during maintenance or for repair be supplied by an authorized Moomba dealer.

NOTICE: You are responsible for keeping records of all maintenance on your boat. To maintain your new boat warranty, you may be asked to show that required maintenance was performed.

COOLING SYSTEMS

FRESH WATER COOLING SYSTEM

The standard cooling system for Moomba boats is an open circulating cooling system with water intake. This is preferred for lakes and reservoirs with low salt content. If the engine is occasionally operated in salt water, the cooling system should be flushed with fresh water periodically and always before storage. If your boat is regularly operated in salt water it should be equipped with the optional salt water package.

SALT WATER COOLING SYSTEM

The optional cooling system for use on salt water is a closed system with a solution of 50% antifreeze and 50% fresh water. The coolant is left in the closed system and replaced once a year.

OIL FILTER & FUEL FILTER

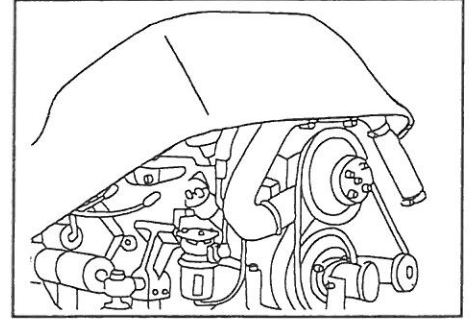

The Oil Filter is located below the engine. The engine manufacturer recommends that you change the oil and oil filter after the first 10-20 hours use of your new boat. Thereafter, to maximize engine life, change oil and filter after every 50 hours of use (See Engine Manual.)

The Fuel Filter is mounted on the lower front of the engine on the starboard side. Change the fuel filter after each 100 hours of use or at least once each year (See Engine Manual.)

MAINTENANCE CHART

MAINTENANCE INTERVALS AT ENGINE HOURS

	weekly	1st 25	50 hr	100 hr	yearly
Change Engine Oil		✓	✓	✓	✓
Replace Oil Filter		✓	✓	✓	✓
Clean Oil Filler Cap				✓	
Check Transmission Fluid Level	✓	✓	✓	✓	✓
Change Transmission Fluid					✓
Check Sea Water Strainer	✓ *	✓ *	✓ *	✓	✓
Clean Flame Arrestor		✓		✓	✓
Clean Crankcase Ventilating System		✓	✓		✓
Check Water Pump & Alternator Belt Tension	✓	✓			✓
Change Fuel Filter					✓
Check Fuel Lines & Connections for Leaks	✓	✓	✓	✓	✓
Clean Carburetor Fuel Inlet Filter		✓	✓	✓	✓
Clean Transmission Oil Strainer Screen					✓
Lubricate Distributor Cam					✓
Shaft Packing Log		✓	✓	✓	✓
Check Condition of Spark Plugs					✓
Check Battery Electrolyte Level		✓	✓	✓	✓
Check All Electrical Connections		✓			✓
Check Cooling System Hoses for Leaks	✓	✓			✓
Tighten Engine Mount Fasteners					✓
Lubricate Throttle and Shift Linkage Pivot Points					✓
Check for Loose, Damaged or Missing Parts	✓	✓			✓
Check Engine to Propeller Shaft Alignment		✓		✓	✓

* If engine overheats, visually check. If clogged, remove debris.

This inspection and maintenance schedule is recommended for average operating conditions in normal service. Under severe operating conditions or service, intervals should be shortened.

TRANSMISSION

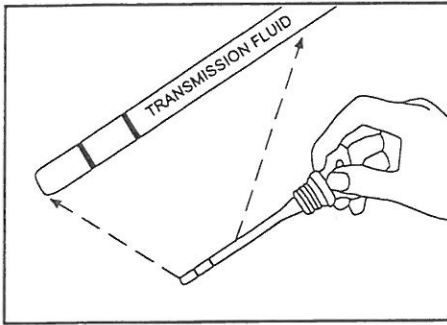

Use only Dextron III transmission fluid in transmissions with 1:1 drive train. To check fluid level refer to Engine Manual.

CHANGE FREQUENCY

Change transmission fluid every year (refer to Engine Manual.)

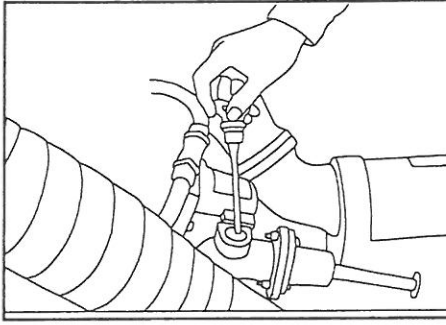

MAINTAINING FLUID LEVEL

Transmission fluid level should be checked regularly (such as every 10 engine hours) and fluid added if necessary. Maintain fluid level as follows:

- Boat must be at rest.
- Engine should be at operating temperature but turned off while checking level.
- Remove transmission fluid dipstick.
- Wipe fluid clean from dipstick and replace.
- Remove dipstick and note level indicated by the upper and lower marks.
- If required add fluid to bring the level to the upper mark.

INFREQUENT LUBRICATION

Normal use of your Moomba causes metal to metal movement at some parts in the boat. Driver seat track should be lubricated with a water resistant chassis lubricant such as silicon grease.

Lubricate rudder grease fitting once annually.



SHAFT LOG PACKING NUT

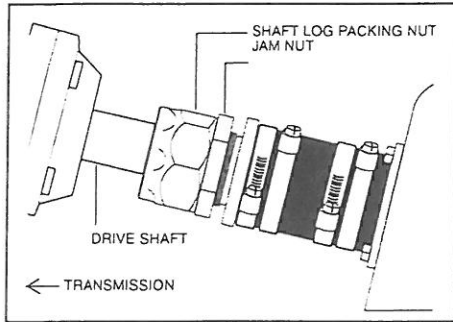

The Shaft Log Packing Nut should be checked periodically and adjusted if needed.

Adjust as follow:

1. Loosen the jam nut a few turns.
2. Tighten the shaft log packing nut by hand. **DO NOT** over tighten.
3. Tighten the jam nut against the packing nut.
4. Check for leaks.

NOTICE: It is normal for the Packing Log to drip water at a slow rate of one drop every 15 to 30 seconds. Overtightening the packing nut may disturb the packing and cause excessive dripping.

BATTERY CABLE INSTALLATION AND PRECAUTIONS

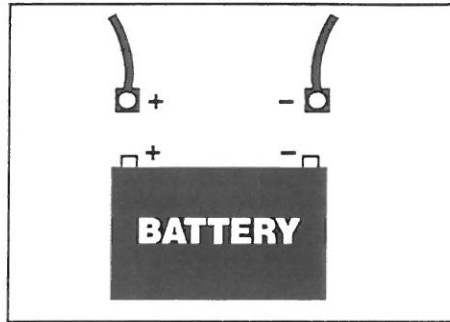

Your Moomba electrical system is negative ground. The negative battery cable is grounded on the engine block. The positive battery cable is connected to the starter solenoid.

Connect the positive (+) battery cable to the positive (+) post on the battery. Connect the negative (-) battery cable to the negative (-) post on the battery.

CAUTION Failure to connect battery cables as outlined will damage the system and void the warranty.

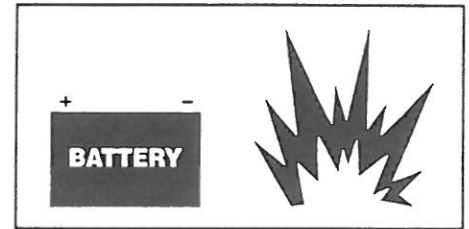

WARNING Hydrogen and oxygen gases are produced during normal battery operation and charging. Sparks or flames near the battery vent openings can cause the mixture to ignite and explode.

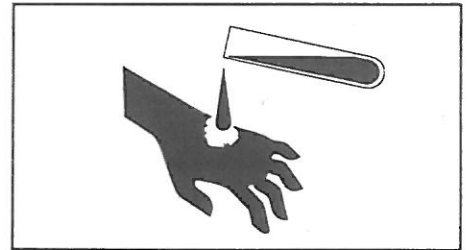

WARNING Sulfuric acid in the battery can cause serious burns. If spilled on skin or in eyes, flush with clean water immediately, then seek medical attention.

CLEANING, CARE AND STORAGE

FIBERGLASS CARE

Washing and waxing the boat hull and deck regularly will extend the life and beauty of your Moomba. It is a good routine to rinse your boat with fresh water after each day's use.

It is recommended that the hull and deck be cleaned and waxed after every 50 hours of use. This will decrease water friction and lessen the potential for staining or spotting on the gelcoat surface.

When the original gelcoat shine cannot be restored by waxing, the shine may be restored by hand buffing with a commercial polishing compound. Be sure to apply a new coat of wax containing Carnauba over the area that has been polished.

IMPORTANT: Porcelain cleaning powders are too abrasive for use on gelcoat and may cause permanent discoloration if used. Household detergents containing ammonia or chlorine should not be used on gelcoat. Never use acetone or ketone solvents to clean your boat finish.

WASHING YOUR MOOMBA

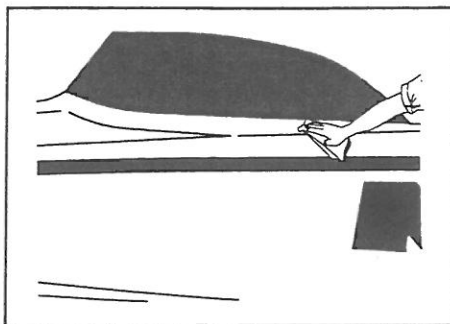

The easiest way to preserve the beauty of your boat is to keep it clean by frequent washing. Wash the boat with luke warm or cold water. Wipe the boat down immediately after washing to avoid water spots. Avoid using hot water or washing your boat in direct sunlight. Avoid using strong soaps or chemical detergents. To avoid spotting, all cleaning agents should be thoroughly rinsed from the surface promptly and not allowed to dry on the finish.

RUB RAIL CARE

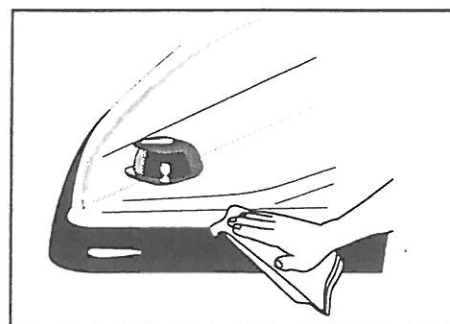

Use a sponge or other soft material to wash and wax the rubber rub rail.

To wax, use a commercial automotive black bumper wax.

NOTICE: When tying up to a dock or another boat, always use cushioned fenders (dock bumpers) to protect your boat from hard surfaces.

WINDSHIELD CARE

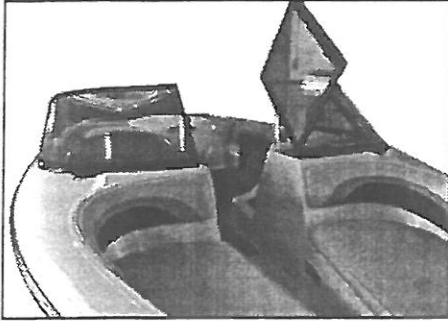

Clean the windshield regularly to insure that visibility is not obstructed.

Use a commercial glass cleaner to remove any spotting or stubborn stains that develop on the windshield.

Never use abrasive cleaners on glass or plastic surfaces as they may cause scratches.

UPHOLSTERY CLEANING

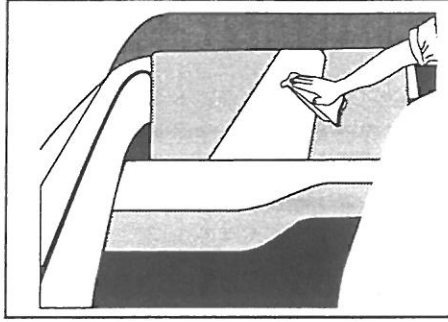

All upholstery items on your boat are made of tough marine grade vinyl that is easily cleaned with a mild detergent.

CAUTION Strong detergents and cleaners may shorten the life of the vinyl. PLEASE SEE VINYL MANUFACTURER'S RECOMMENDED CARE GUIDE INCLUDED IN YOUR OWNER'S PACKAGE.

DRYING UPHOLSTERY

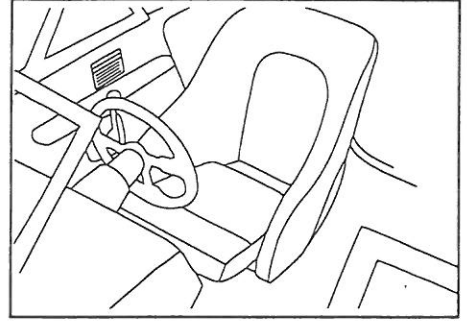

It is important to provide for the drying of all upholstery and carpet after each use of the boat. Open all storage compartments and slide all removable cushions out about an inch to allow air to circulate behind.

WINTERIZATION & DRY STORAGE

When the boating and ski season comes to a close, it is recommended that your Moomba boat be removed from the water and stored for the winter months.

CAUTION It is extremely important to follow the proper winterizing procedure. The engine must be correctly winterized for safe storage in your climate. This should be done by a professional. Your Moomba dealer will know exactly what must be done to insure the longest possible life for your boat.

In addition to preparing the engine the following tasks should be done to winterize the boat:

1. Remove the center drain plug from the boat.
2. Thoroughly clean the boat inside and out. Inspect the hull for any residue or algae growth and remove if required.
3. Clean the bilge area thoroughly and operate the bilge pump to remove any water from the bilge hose.

4. Remove all seat cushions and open all storage areas to air circulation in the boat interior. When thoroughly dry, replace cushions and close storage areas.
5. Top off fuel tank to prevent any condensation from accumulating in the fuel system. Use a commercially available fuel stabilizer to remove water and prevent gumming.
6. If the boat is stored on its trailer, insure that the boat is properly positioned. If possible lift the tongue so that the bow is slightly raised to promote drainage from the center drain hole.
7. Install the canvas cover and secure the straps in accordance with cover instructions.

NOTICE: During the winter months, water is a boat's worst enemy. Always store the boat when the interior is completely dry. Periodically check on the condition of the stored boat.

BOAT HULL PROTECTION

If your boat is to remain in salt water for an extended period of time, the hull should be painted with a protective marine bottom paint.

Hull protection may also be advisable when storing in fresh water where algae or plants are abundant.

HOISTING

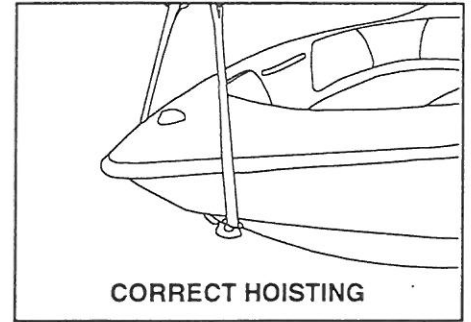
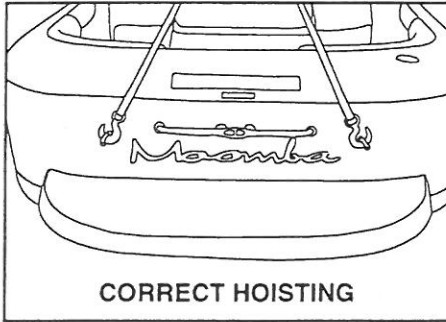
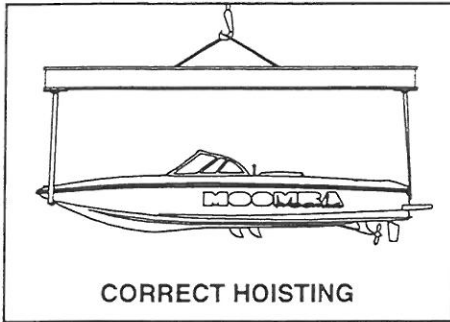

If the boat ever needs to be hoisted, special attention should be given to the following recommendations:

- Hoist the boat using a horizontal lifting bar.
- Never attempt to lift the boat by means of a cable sling from bow to stern.
- At the bow use heavy-duty nylon webbing strap run through the bow eye then around the nose to a lifting hook above.

- At the stern use heavy-duty nylon webbing strap run through each lifting ring then up to a lifting hook above.
- To avoid damaging fiberglass finish, bow eye or stern ring, never attach lifting hook directly to the boat.
- Hoist operator should make only slow, smooth motions in lifting the boat.

⚠ WARNING DO NOT use ski pylon to hoist the boat.

⚠ WARNING Incorrect hoisting may invalidate the warranty on the boat.

CANVAS COVER

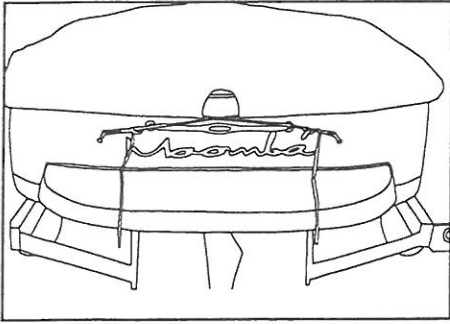

Your Moomba boat cover is made from the finest canvas and webbing to insure that your boat will be protected in the off season. The cover has been designed to fit securely around each boat. If your new cover does not seem to be snug, a shrinkage allowance has been sized in.

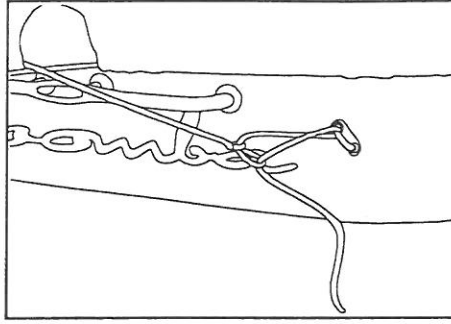

Use the following procedure when covering the boat:

1. Be sure that the cover fits snugly at the bow then unfold from front to back.
2. Secure all fastening straps around the trailer frame.
3. Pull the draw cord equally from both sides and tie off to the lifting eyes on the stern in accordance with the illustration.



FOLDING COVER

When folding the cover for storage be sure that it is dry. Take care not to scratch the canvas finish against rough surfaces. Store in a dry location.

COVER REPAIR

If the cover becomes damaged, immediately patch and reseal the area. Use a tent seam sealer to reseal any new stitches. Spray fabric guard on scraped or worn surfaces. Canvas tears should be repaired professionally and stitches sealed to prevent leakage.

IDENTIFICATION NUMBER

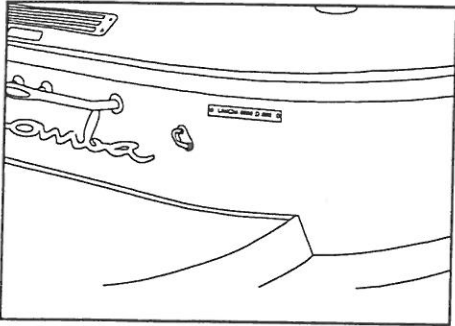

The hull identification number is located on the upper right hand side of the transom below the rub rail.

The following describes the identification number in detail.

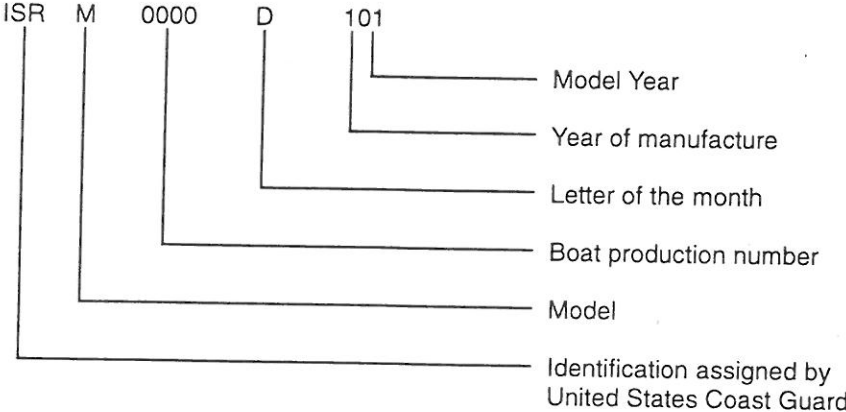

BATTERY SPECIFICATIONS

12 Volt marine type with tapered post connectors.



Cold Crank
@ 0°F (-18°C)

650 Amps

⚠ WARNING Hydrogen and oxygen gases are produced during normal battery operation or charging. Sparks or flames can cause this mixture to ignite and explode if it comes near the vent openings. Sulfuric acid in battery can cause serious burns, if spilled on skin or in eyes. Flush with clear water immediately.

TECHNICAL INFORMATION

ENGINE & TRANSMISSION DATA

Engine Model: Indmar Assault MPI

Fuel Delivery: Multi Port Fuel Injection
 Horsepower: 330-hp
 Displacement: 350-ci
 Bore (in): 4.00
 Stroke (in): 3.48
 Compression Ratio: 9.4 to 1
 Electrical System: 12-V Neg Ground
 Ignition Type: Electronic Distributor
 Alternator Output: 51 Amps @2,200 RPM
 Thermostat: 143 Degrees F
 Firing Order: 1-8-4-3-6-5-7-2
 Initial Timing: 10 Degrees / Service Mode
 Oil Filter: Pennzoil PZ-3
 Oil Capacity: 5-Quarts
 Oil Type: Pennzoil 15W-40 Marine
 Transmission Fluid: Dextron III-Mercon
 Spark Plugs: AC MR43LTS
 Gap: 0.045
 Max RPM's: 5,200 RPM

Engine Model: Indmar Assault TBI

Fuel Delivery: Throttle Body Fuel Injection
 Horsepower: 320-hp
 Displacement: 350-ci
 Bore (in): 4.00
 Stroke (in): 3.48
 Compression Ratio: 9.4 to 1
 Electrical System: 12-V Neg Ground
 Ignition Type: Electronic Distributor
 Alternator Output: 51 Amps @2,200 RPM
 Thermostat: 143 Degrees F
 Firing Order: 1-8-4-3-6-5-7-2
 Initial Timing: 10 Degrees / Service Mode
 Oil Filter: Pennzoil PZ-3
 Oil Capacity: 5-Quarts
 Oil Type: Pennzoil 15W-40 Marine
 Transmission Fluid: Dextron III-Mercon
 Spark Plugs: AC MR43LTS
 Gap: 0.045
 Max RPM's: 4,850 RPM

V-Drive: Walters

Model: RV-26 D
 Ratio: 1.46 to 1
 Oil Type: SAE-30
 Oil Capacity 2 pints

MOOMBA WARRANTY

Moomba is proud of our product and to show it we back it up with a lifetime warranty. This dedication proves that we only use the finest quality materials and meticulously manufacture every Moomba Boat so that you get the finest value boat on the market!

MOOMBA Lifetime Limited Warranty

There are no express or implied warranties on products manufactured or sold by Skier's Choice, Inc. except as set forth in this Limited Warranty Agreement. Except as excluded or limited in this Warranty, Skier's Choice, Inc. warrants to the first owner that this new Moomba Outback, Kanga, or Mobius boat is free from defects in materials and workmanship, under normal use and when operated and maintained according to instructions for the term set forth as follows:

For a period of twelve (12) months from the date of purchase on all covered components other than the deck, hull, flooring, and stringers;

For the lifetime of the product on the deck, hull, flooring (excluding carpet) and stringers.

SKIER'S CHOICE, INC.'S OBLIGATIONS:

Skier's Choice, Inc. will repair or replace, at its sole option, any part covered under this Warranty which is returned by the owner during the warranty period to Skier's Choice, Inc.'s factory or to any other Moomba authorized repair facility and which, upon Skier's Choice, Inc.'s examination, discloses to Skier's Choice, Inc.'s satisfaction a defect at the time of delivery to the first owner. In case of such defect, Skier's Choice, Inc. will fulfill its obligation to repair or replace the defective item within ninety (90) days of receipt of

the defective part at its factory or any Moomba authorized repair facility. Replacements will be warranted only for the remainder of the original warranty period. The repair or replacement of defective parts under warranty will be made by Skier's Choice, Inc. without charge to the owner for parts or labor. Transportation of the boat or parts to the authorized Moomba facility shall be borne by the owner and return transportation charges shall be prepaid by the owner. The replacement or repair of the defective part as stated in this Warranty shall be the sole remedy of the Purchaser and the sole liability of the Dealer and the Company under the Warranty and any implied warranties.

MOOMBA EXCLUSIONS

The following are specifically excluded from coverage under this Warranty:

Anyone other than the first owner.

Paints, varnishes, gelcoat surfaces and colors, finish distortions, chrome plated or anodized finishes, floor covers and any other surface coatings.

All component parts and accessories not manufactured by Skier's Choice, Inc., including but not limited to, engines, gear trains, drive trains, transmissions, propellers, shift and throttle control levers and cables, bilge pumps, other pumps, blowers, windshields, canvas, upholstery, batteries, instrumentation, and steering systems. However, where any such items are warranted by a component or accessory manufacturer, Skier's Choice, Inc. will, if possible, furnish the warranty document to the owner. Subsequent damage from bilge pump failure or other component part failure will not be the responsibility of Skier's Choice, Inc.

Any equipment installed by a Dealer or any other installer.

Any boat which is: (a) used for rental or other commercial, military or industrial purposes; (b) used in boat racing, demonstrations or similar events; (c) altered, modified, repaired or replaced so as to increase the cubic inch capacity or horsepower output of the engine and boat as originally manufactured.

Speeds, fuel consumption and other performance characteristics because they are estimated and may vary.

Any damage or repair required because of misuse, negligence, accident, collision or impact with any object; or any improper alteration or repair.

Any boat used for speed, competition or performance demonstration.

The Lifetime Warranty on the deck, hull, flooring and stringers does not include hardware or other components fastened or adhered to the hull, deck, flooring or stringers.

If you must leave your boat in the water for long periods of time, a condition may develop wherein the hull may show signs of discoloration. This discoloration will not be covered for warranty by United Marine Corp. nor our raw materials supplier.

Skier's Choice, Inc. reserves the right to improve its products through changes in design or material without being obligated to incorporate such changes in products of prior manufacture.

MOOMBA OTHER LIMITATIONS MOOMBA

THIS WARRANTY LIMITS THE DURATION OF ANY IMPLIED WARRANTY OF MERCHANTABILITY OR IMPLIED WARRANTY OF FITNESS FOR A PARTICULAR PURPOSE TO THE PERIOD OF TWELVE (12) MONTHS

(LIFETIME ON THE DECK, HULL, FLOORING AND STRINGERS) FROM THE DATE OF PURCHASE. Some states do not allow limitations on how long an Implied Warranty lasts, so this limitation may not apply to you.

THE REMEDIES OF REPAIR OR REPLACEMENT AT OUR OPTION, AS SET FORTH ABOVE, ARE THE ONLY REMEDIES UNDER THIS WARRANTY. UNITED MARINE CORP. DISCLAIMS ANY OBLIGATION OR LIABILITIES FOR LOSS OF USE OF PRODUCT WARRANTED, LOSS OF TIME, INCONVENIENCE, COMMERCIAL LOSS OR ANY OTHER DIRECT, CONSEQUENTIAL, SPECIAL OR INCIDENTAL DAMAGES. Some states do not allow the exclusion or limitation of incidental or consequential damages, so the above limitations or exclusions may not apply to you.

THIS WARRANTY IS IN PLACE OF ANY OTHER EXPRESS WARRANTIES.

THIS WARRANTY APPLIES TO THE FIRST OWNER ONLY.

THIS WARRANTY GIVES YOU SPECIFIC LEGAL RIGHTS, AND YOU MAY ALSO HAVE OTHER RIGHTS WHICH VARY FROM STATE TO STATE.

THIS WARRANTY IS EXPRESSLY IN LIEU OF ANY CONTRACTUAL LIABILITIES, INCLUDING PRODUCT LIABILITIES.

THE DEALER IS NOT THE AGENT OF SKIER'S CHOICE, INC. THE COMPANY DOES NOT AUTHORIZE THE DEALER, OR ANY OTHER PERSON, TO ASSUME FOR THE COMPANY ANY LIABILITY OR EXPENSE INCURRED IN THE REPAIRING OF ITS PRODUCTS OTHER THAN THOSE EXPRESSLY AUTHORIZED IN THIS LIMITED WARRANTY. THE DEALER MAY NOT EXTEND OR IN ANY WAY CHANGE OR AMEND THIS EXPRESS WARRANTY.

OWNER'S RESPONSIBILITIES

- A. Before operating your Moomba, it is necessary to read and fully understand this Owner's Manual and all other information delivered with the boat.
- B. It is the owner's responsibility to take the boat to an authorized Moomba dealer to obtain warranty service.
- C. It is the owner's responsibility to properly operate and maintain the boat in accordance with this manual and all other information delivered with the boat.
- D. The owner should keep maintenance records should it be necessary to show that required maintenance has been performed on the boat.

DEALER'S RESPONSIBILITIES

- A. The Dealer should provide the buyer with an adequate orientation in the general operation of the boat and review all systems and accessories included with the boat.
- B. The Dealer should deliver a complete owner's packet with the boat consisting of Owner's Manual, Registration, Engine Manual, Stereo Manual, Moomba Warranty and all warranties for separately warranted items aboard the boat.
- C. The Dealer should review all warranty information with the buyer and assist in filling out warranty cards if necessary.
- D. The Dealer should insure that any information or obligation from either Skier's Choice, Inc. or from the dealership is clearly understood by the buyer.
- E. The Dealer should instruct the buyer in obtaining local service and out-of-area service for a Moomba boat.

CUSTOMER ASSISTANCE

The staff at Skier's Choice, Inc. is concerned with your complete satisfaction. This includes the prompt resolution of any problems that may arise during the warranty period. Normally, problems encountered may be efficiently and effectively resolved by your Moomba Dealer. However, if a problem cannot be handled by the Dealer or if a solution is not satisfactory to you as the Owner, please follow these steps to get the matter resolved:

STEP ONE

Discuss the problem with a member of your Moomba Dealer's management staff. It is most likely that the problem will be resolved at this level.

STEP TWO

If the Dealer management does not resolve the problem to your satisfaction, please have the problem and all action taken documented by the Dealer, then contact the factory Customer Service Representative at Skier's Choice, Inc.:

Telephone (865) 856-3035
Skier's Choice, Inc.
5820 Highway 411 South
Maryville, TN 37801

Describe the original problem in detail to the Customer Service Representative. Be prepared to furnish appropriate documentation and the reasons why service by the Dealer was unsatisfactory. If further action is required to resolve the problem, the Customer Service Representative will dictate the appropriate action.

STEP THREE

Finally, if after following these steps and providing documentation and after obtaining necessary authorization from the Customer Service Representative to take additional action, the problem is still not resolved to your satisfaction, the President of Skier's Choice, Inc. will personally review the problem and make a determination concerning final resolution.

INDEX

Accessory Power Switch	23	Gauges	
Battery Box	28	Engine Hours	22
Battery and Cable Installation	40	Fuel	18
Battery Specifications	47	Oil Pressure	23
Bilge Pump Switch	24	Temperature	25
Blower Switch	25	Voltmeter	23
Boat Specifications	3	Hoisting	44
Bow Eye	33	Horn	26
Bow Light	32	Hull Protection	43
Break-in Period	16	Hull Identification Number	56
Canvas Cover	45	Identification Number	46
Coast Guard Regulations	12	Ignition	22
Cooling Systems	37	Instrument Panel & Controls	20
Customer Assistance	52	Keys	
Dealer's Responsibilities	51	Ignition	27
Drain Plug	16	Gas	27
Engine Data	48	Lifting Rings	33
Engine Hour Gauge	22	Lubrication	
Fiberglass Care	41	Infrequent	39
Fire Extinguisher	30	Maintenance Chart	38
Fuel		Maximum Capacities	12
Filling the Fuel Tank	17	Mirror	27
Gauge	18	Motor Box	29
Information	17	Navigation Lights	24
Precautions	17	Neutral Transmission Lock Out	15
Tank	17		

INDEX

Oil		
Dipstick	19	
Filter	37	
Level Check	19	
Pressure Gauge	23	
Specifications	19	
Pole Light	32	
Pole Light Receptacle	32	
Propeller	34	
Propeller Precaution	35	
Rad-A-Cage	31	
Rub Rail	41	
Safety Equipment	12	
Seats		
Adjustment	28	
Cushion Care	42	
Driver	28	
Service & Maintenance	36	
Shaft Log Packing Nut	40	
Ski Locker/Sun Deck	35	
Ski Platform	33	
Ski Pylon	30	
Speedometer	21	
Speedometer Pickups	21	
Starting	13	
Steering Tilt Adjustment	25	
Tachometer	22	
Temperature Gauge	25	
Throttle Lever	15	
Trailer	7	
Boat Hook-up	10	
Loading Procedure	10	
Trailer Alignment	11	
Unloading Procedure	9	
Transmission Fluid Check	39	
Transmission Fluid Specifications	39	
Transmission Lock Out	15	
Upholstery		
Care & Cleaning	42	
Drying	42	
Dry Storing	43	
Voltmeter	23	
Windshield	34	

Warranty is VOID if Registration Card is not completed and returned to Skier's Choice, Inc. with 15 days of purchase date.

PLACE
STAMP
HERE

Skier's Choice, Inc.
5820 Highway 411 South
Maryville, TN 37801