

Sales  
Copy

# OWNER'S MANUAL

# MOONRA

The Ski Boat Company

Boomerang  
Outback



# DAILY CHECK LIST

## BOATMAN'S CHECK LIST

For maximum enjoyment and safety, check each of these items **BEFORE** you start your engine:

- ✓ **DRAIN PLUGS** (Securely in place?)
- ✓ **LIFE-SAVING DEVICES** (One for every person on board?)
- ✓ **STEERING SYSTEM** (Working smoothly and properly?)
- ✓ **FUEL SYSTEM** (Adequate fuel? Leaks? Fumes?)
- ✓ **BATTERY** (Fully charged? Cable terminals clean and tight?)
- ✓ **ENGINE** (In neutral?)
- ✓ **CAPACITY PLATE** (Are you overloaded or overpowered?)
- ✓ **WEATHER CONDITIONS** (Safe to go out?)
- ✓ **ELECTRICAL EQUIPMENT** (Lights, horn, pump, etc.?)
- ✓ **EMERGENCY GEAR** (Fire extinguisher, bailer, paddle, anchor & line, signaling device, tool kit, etc.?)
- ✓ **BILGE PUMP** (Working properly?)

**NOTICE: Bilge pump should be checked prior to each use to insure proper operation!**

## CHECK BEFORE RUNNING

1. Engine oil level.
2. Transmission lubricant level.
3. Engine drain plug, transom drain plug, and center drain plug.
4. Leakage (fuel and water lines and connections).

**! CAUTION** DO NOT operate engine without cooling water flowing through water pump or water pump will sustain damage, and subsequent engine damage may result.

## CHECK WHILE RUNNING

1. Oil pressure of 35-40 psi at 2000 RPM.
2. Water temperature 140° - 160° for raw water systems (water is not recirculated), and 180° - 200° for fresh water systems (water is recirculated).
3. Idle RPM (550 - 600) in gear.
4. Maximum forward 4400 RPM.
5. Shifting linkage (forward, neutral, and reverse).



**! WARNING** It is very important to check for fuel spillage or leaks prior to each use of your boat.

Gasoline vapors can explode!  
Before starting engine:

- Check engine compartment for gasoline vapors.
- Operate blower for 4 minutes.
- Always operate blower below cruising speed.

**NOTICE: See Engine Manual for maximum RPM and engine break-in procedure.**

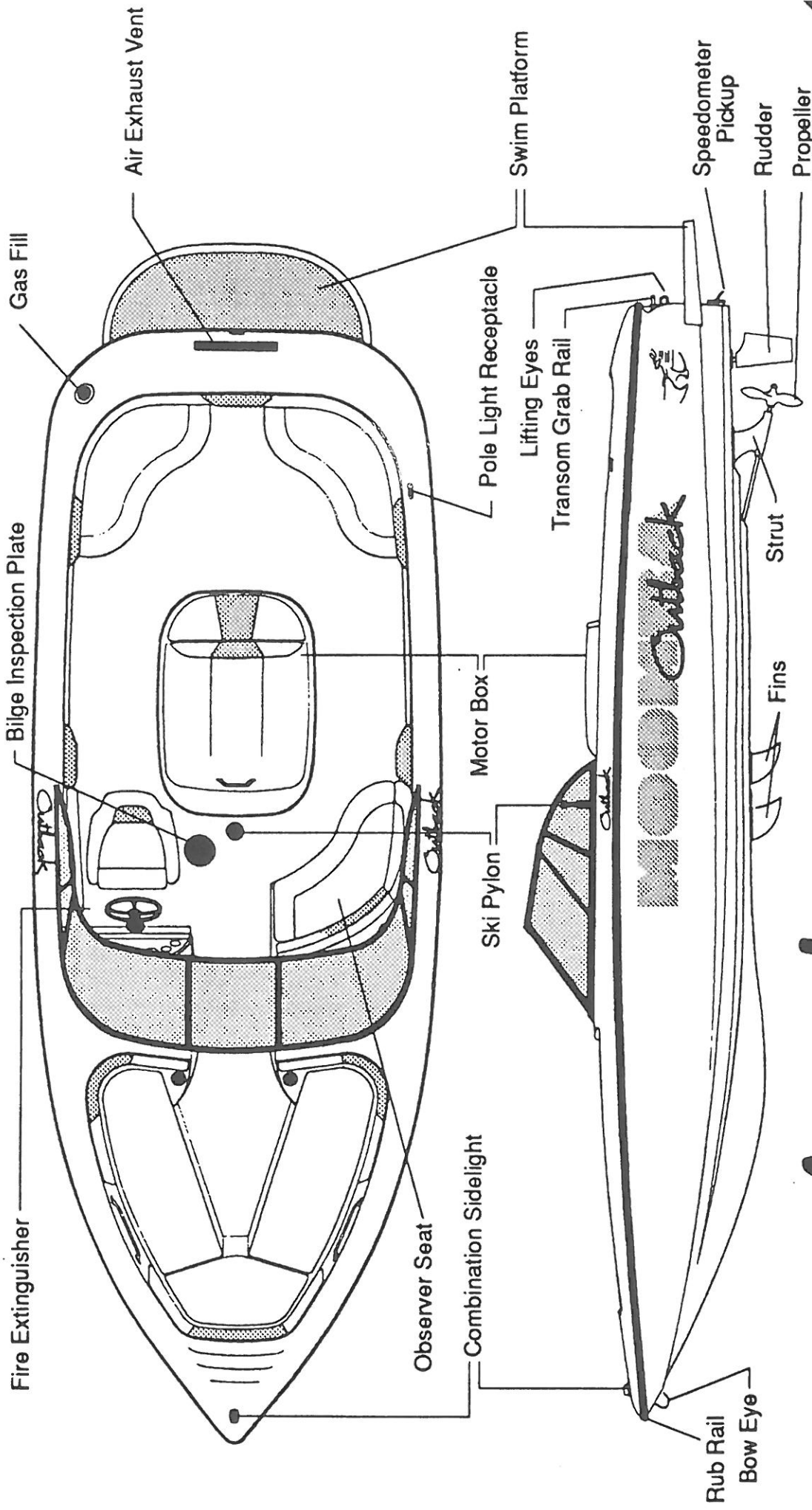

# Outback

## OUTBACK SPECIFICATIONS

Length without platform	20'6"	Capacity:	8 adults
Beam:	92"	Fuel Capacity:	30 gal.
Draft:	24"	Standard Power:	260 HP
Weight:	2,350 lbs.	Optional Power:	up to 320 HP



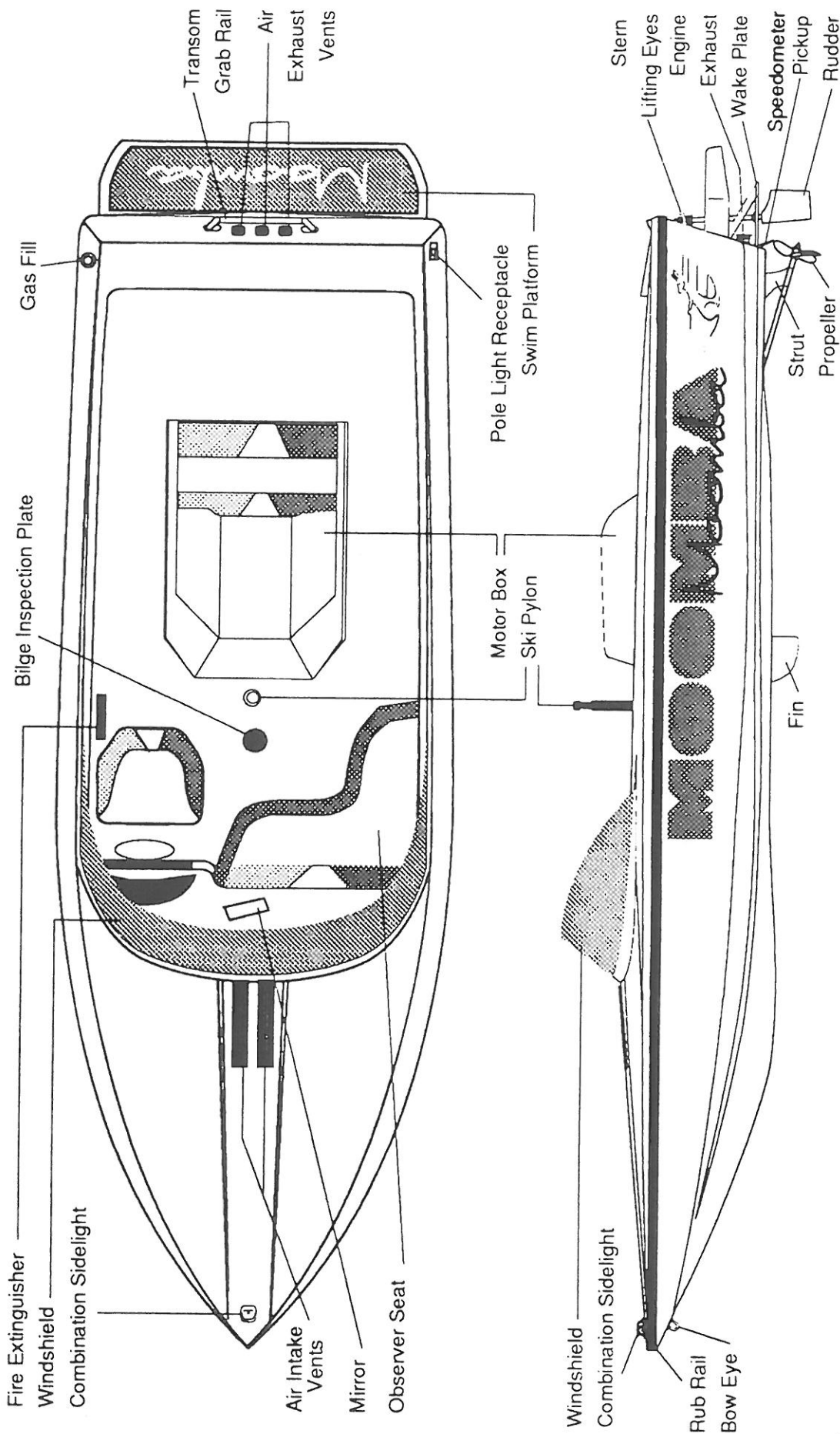

### BOOMERANG SPECIFICATIONS

Length Without Platform:	18' 10"	Capacity:	5 adults
Beam:	6' 8"	Fuel Capacity:	23 gal.
Draft:	21"	Standard Power:	260 hp
Weight:	4000 lb.		





# EQUIPMENT AND OPTIONS

## SEAT ADJUSTMENT

### DRIVER SEAT

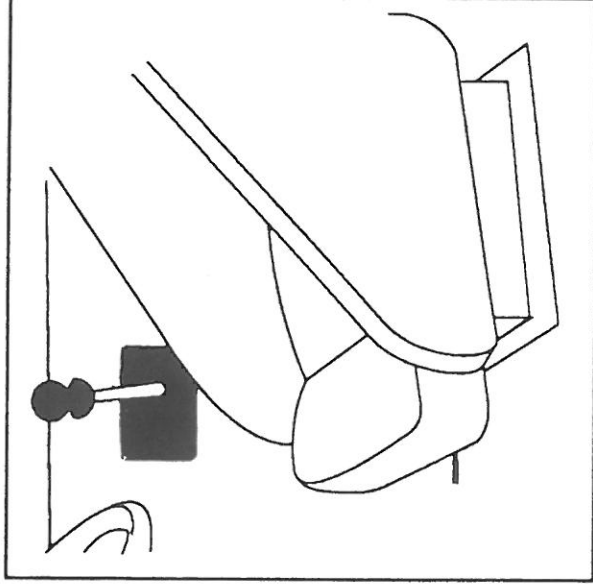

The driver seat may be adjusted forward or backward by moving the lever below the front of the seat. Use body pressure to move the seat to the desired position. Release the lever to lock the seat into place.

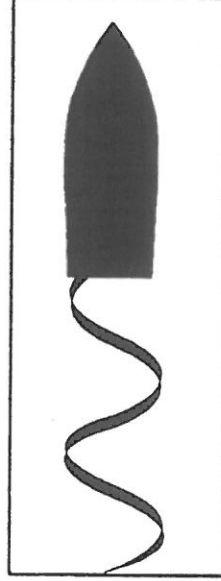

**! CAUTION** DO NOT attempt to adjust driver seat while boat is moving. Sudden seat movement may cause loss of control over the boat.

### IGNITION KEYS

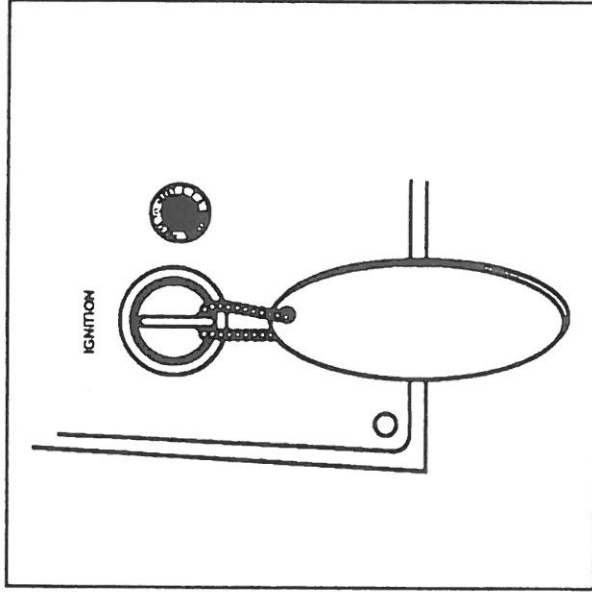

Two ignition keys are provided with the boat. Key entry into the ignition is difficult at times due to the boot protector. Please do not harshly force the key into the ignition. Key tumblers are located vertically, thus the key should be turned vertically when entering the switch.

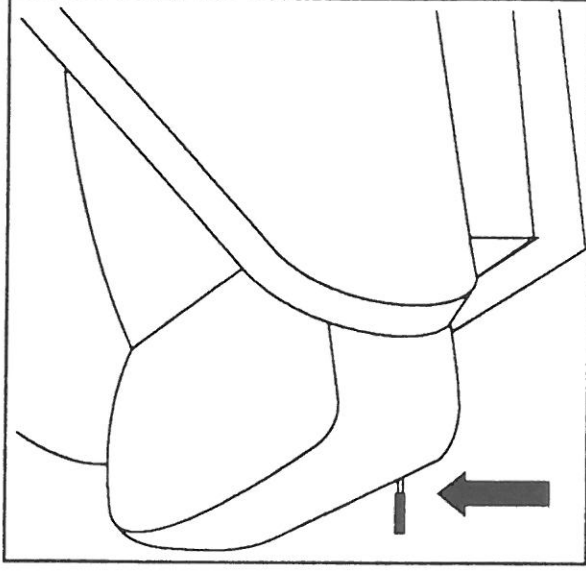

**! CAUTION** After adjusting the seat to the desired position, be sure the seat latch has locked. This is done by pushing forward and backward with the body.



## MIRROR

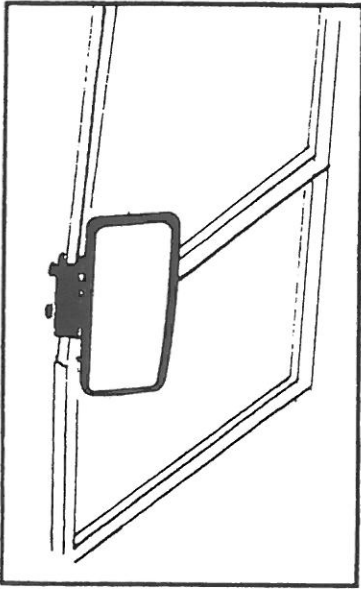

The rear view mirror is mounted on the dash on Boomerang models. An adjustable mirror is furnished with Outback models and may be moved in location or removed for storage.

- Mirror should always be checked before driving.
- Mirror angle may change with each new driver.

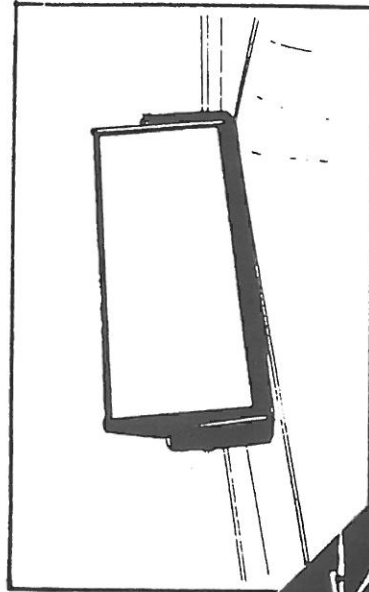

## BATTERY STORAGE

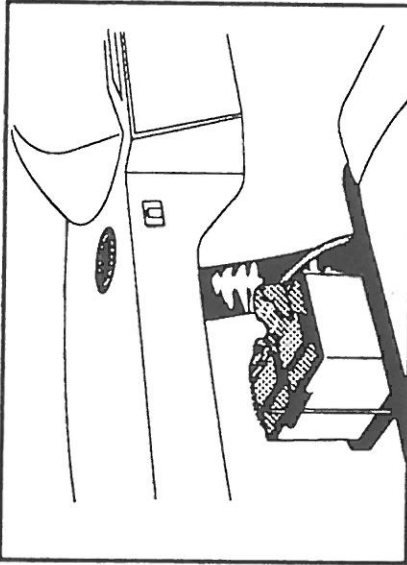

The battery box is securely mounted behind the observer seat cushion back for easy access.

**NOTICE:** It is recommended that the battery cables be removed from the battery when the boat is in transit, on display, or placed in storage.

Battery should be recharged every 30 days when not in use.

(Refer to Battery Cable Installation and Precautions in Chapter 3.)

## MOTOR BOX

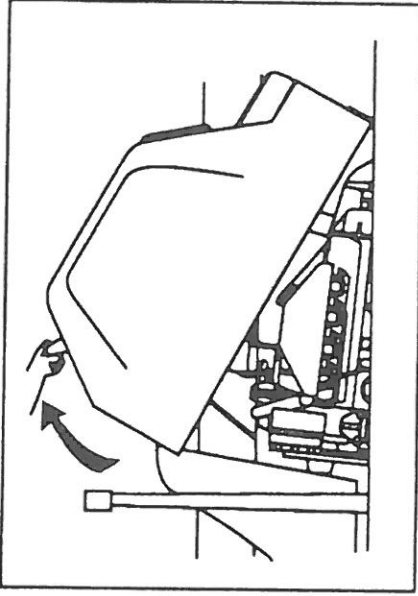

The motor box encloses the inboard engine and quiets engine noise. To open, stand on either the right or the left side of the box toward the stern of the boat.

Grasp handle and pull up at approximately a 45° angle. The motor box will raise up so that engine inspections may be made easily. If the engine requires any repair work, tilt the motor box open until it stays open on its own.

## PULLEY WARNING

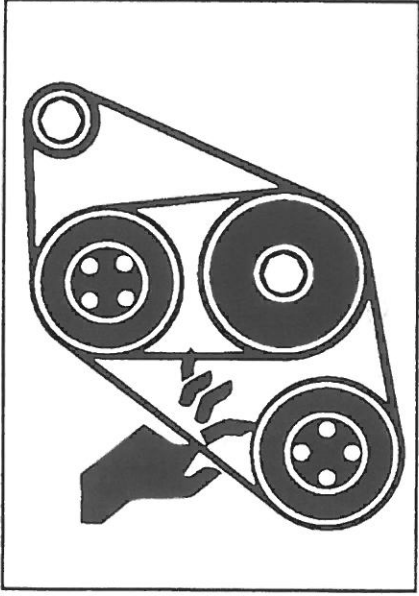

**! WARNING** Pulleys and belts can cause severe injury. Never open motor box while engine is running or while boat is moving!

Remember that after running the boat the engine is extremely hot and should not be repaired until it has cooled down completely.

## SKI PYLON (BAR)

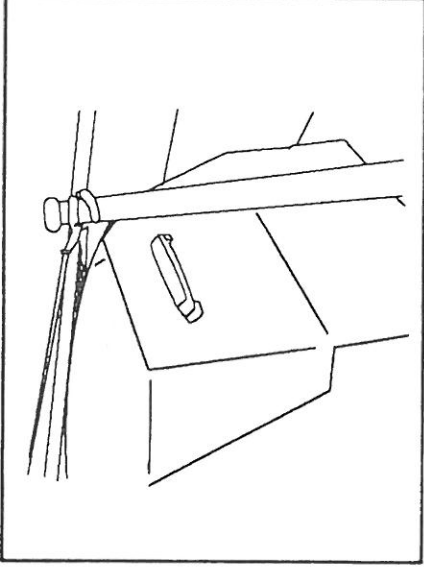

The ski bar is located in the center portion of the boat directly in front of the motor box.

The ski bar is to be used to pull skiers. **DO NOT use ski bar to hoist boat.**

## BILGE INSPECTION PLATE

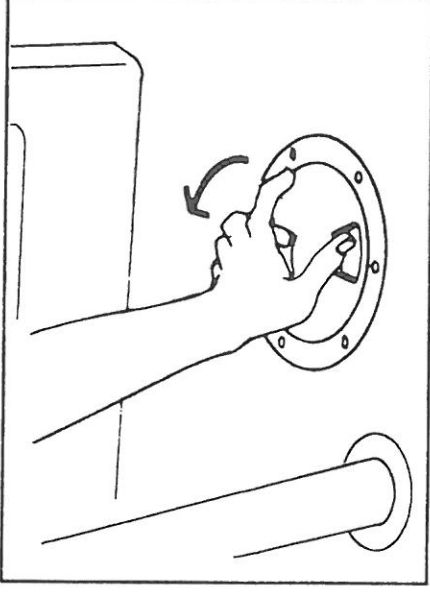

The bilge area inspection plate is located in front of the ski bar. It enables you to check the condition of the bilge area and to remove built-up foreign matter and debris.

**NOTICE: Keep bilge area clean and free of dirt and debris.**

## BOW LIGHT

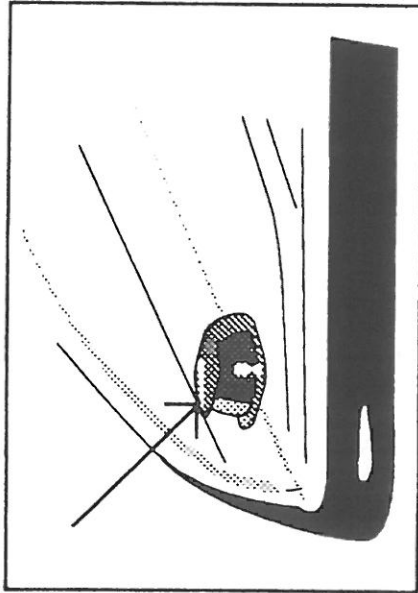

The bow light is located at the very tip of the bow. The light is divided into two colors: green and red. Green signifies the starboard side and red the port side. The purpose is to alert oncoming boats. The color signifies the side on which the oncoming boat should pass.

## STERN LIGHT POLE

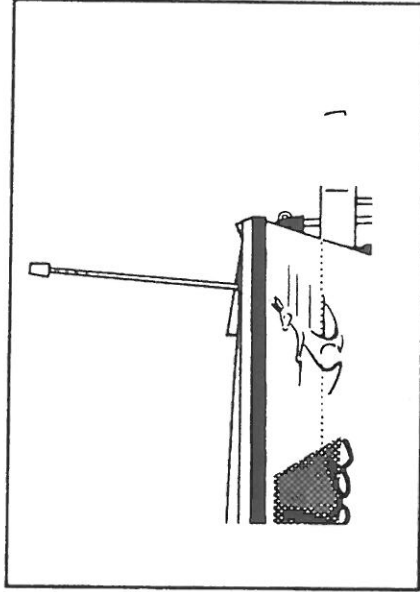

The removable pole light is stored behind the observer's seat. Gently place light into the pole light receptacle.

Pole light must always be in place and illuminated when visibility is a problem and must be displayed while at anchor from sunset to sunrise.

Pole light must be displayed while under way from sunset to sunrise.

**WARNING! DO NOT pull skier with rope attached to ski pylon while pole light is place.**

## POLE LIGHT RECEPTACLE

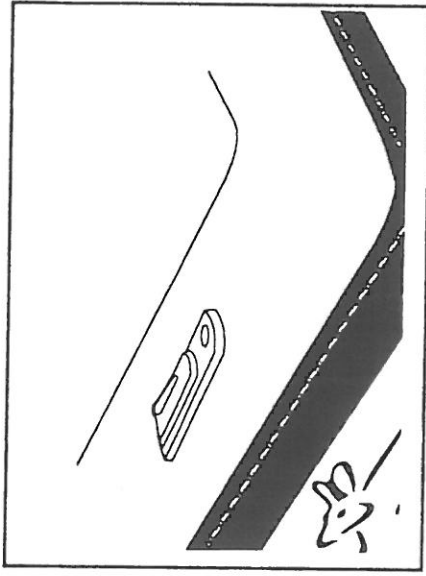

The pole light receptacle is located on the port side near the transom. To install pole light, turn cover on receptacle until completely open. Slide pole light into receptacle so that circuit prongs line up correctly.

## BOW EYE

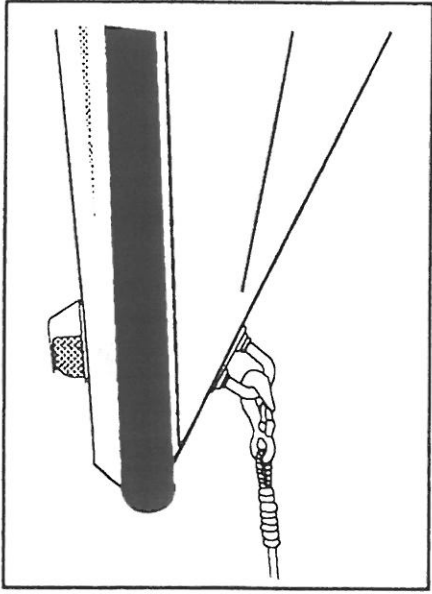

The bow eye is located on the hull below the bow light. Its functions are to lead the boat onto the trailer and secure it to the trailer or to a tie-off while docking.

**WARNING: DO NOT use the BOW EYE to hoist the boat. See page 29 for correct hoisting procedure.**

## FUEL TANK

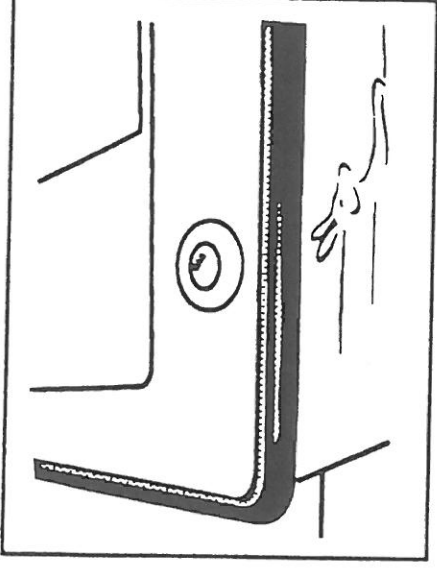

The fuel cap is located on the starboard side of the boat near the transom. Always observe **FUEL PRECAUTIONS** (Page 8) when refueling your Moomba.





## FILLING THE FUEL TANK

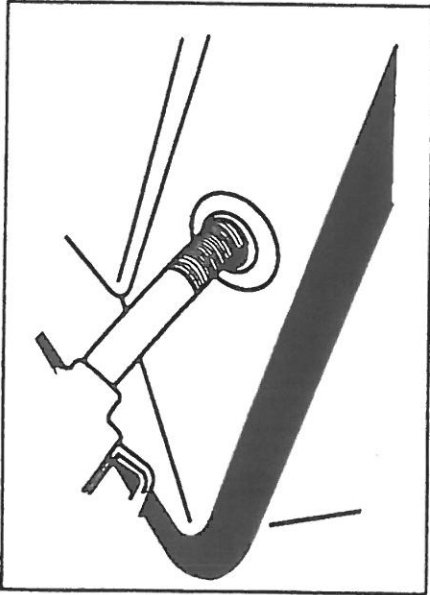

**NOTICE:** Pay careful attention when filling the fuel tank. **DO NOT** overfill the tank! Fuel may exit through fuel vent and damage to finish and/or graphics may result if immediate action is not taken.

If fuel does spill on finish and/or graphics, apply a common non-abrasive bath cleaner and wipe with a damp cloth. Rinse area with clean water.

## FUEL INFORMATION

Use gasoline with a minimum octane rating of 89.

**DO NOT** use gasolines containing any alcohol, ethanol, or methanol. Vapors from these gases are highly flammable.

It is recommended that gasoline types not be changed from one to another.

Gasolines containing detergents, additives, and stabilizers are safe to use.

## FUEL PRECAUTIONS



### **WARNING**

Sparks while fueling can cause an explosion!

### **BEFORE FUELING:**

1. Turn off engine.
2. Turn off all electrical systems.
3. Extinguish cigarettes or any open flame.

### **WHILE FUELING:**

1. Keep hose nozzle in contact with fill pipe to provide a ground against static sparks.
2. Fill tank at a slow rate to avoid any spillage.



## FUEL VENT

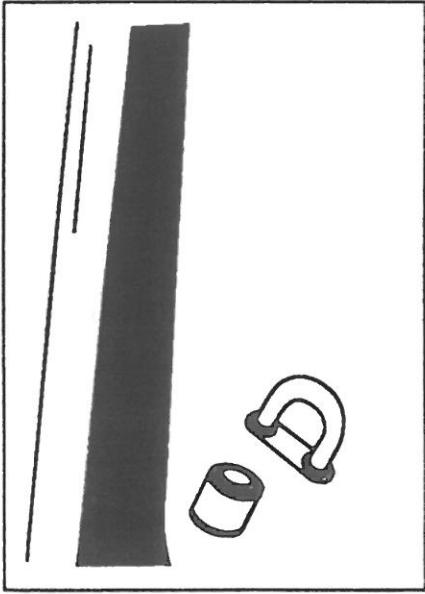

The fuel vent is located on the port side of the transom. It is connected to the fuel tank via the vent hose to release gasoline fumes from the fuel tank.

### **! CAUTION**

To clean or inspect, simply unscrew the cap on the vent, clean and replace. Gasoline vapors are highly explosive.

## FIRE EXTINGUISHER

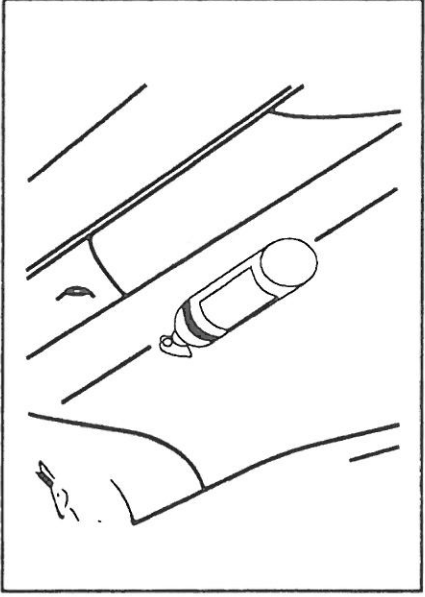

A standard Coast Guard approved fire extinguisher is provided on all Moomba boats. The fire extinguisher is located on the starboard side of the boat behind the driver seat.

(Refer to label instructions for operating procedures.)

## BEVERAGE HOLDERS

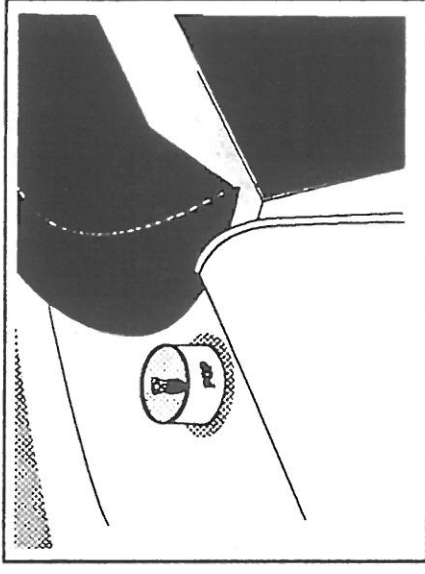

A beverage holder is located next to the dash area on your Moomba. The holder provides a secure place for a beverage and may also be used for temporary storage of small items such as keys, coins, or glasses. Keep the lakes and waterways clean. **DO NOT LITTER.**



## RUB RAIL

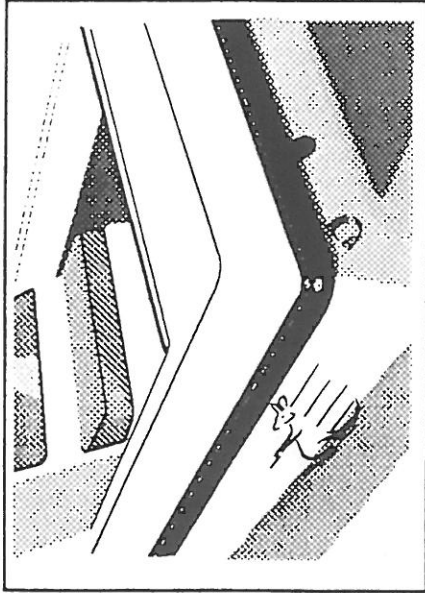

The black rubber rail surrounds the edge of the boat deck to protect it from minor damage which may occur during docking or encounters with other boats.

## WAKE PLATE

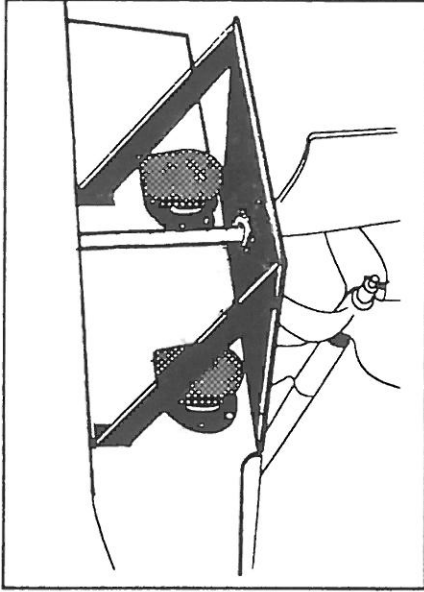

Some Moombas are equipped with a wake plate which is located at the transom below the ski platform. The wake plate is not adjustable.

## PROPELLER PRECAUTION

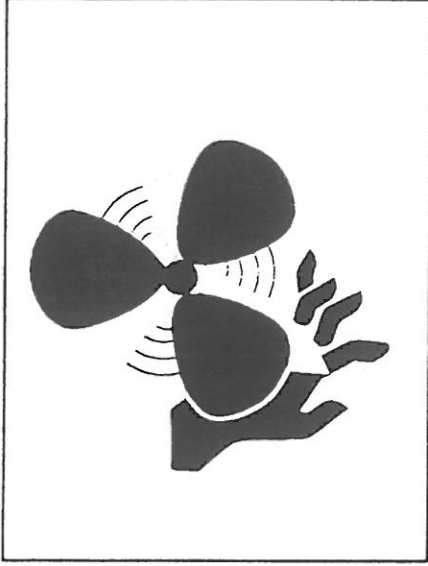

**! DANGER** Moving propeller will cause injury. Propeller may turn with boat in neutral.

## SPEEDOMETER PICKUPS

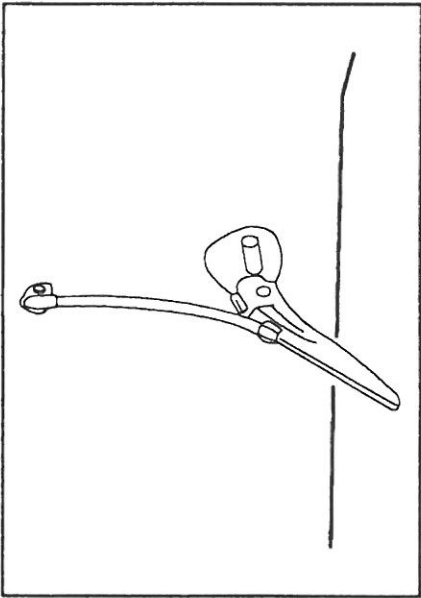

The speedometer tube pickups are located at the stern of the Moomba. These pickups are the means by which the speed of the Moomba is measured. Poor water conditions or foreign objects may clog the pickup hole, thus causing the speedometer to register speed incorrectly.

If the speedometer does not respond after stopping and restarting the engine, inspect tube pickups and clean out any foreign objects. A small wire may be inserted into the tube to clear it out.

The speedometer pickups may pivot 45° off the down position during hard turning and trailering. At this time, the pickups will register a partial speed.

Before unloading or motoring the boat, be sure the pickups are in proper position.

While trailering, the pickups should be adjusted to the up position to relieve air pressure from the system.

## SKI PLATFORM

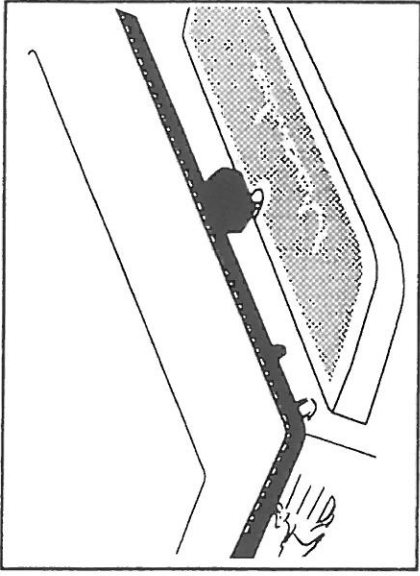

All Moomba boats provide a ski platform at the stern of the boat. The primary function is to provide easy access into and out of the water for skiers and swimmers.

It is recommended that all entries to and exits from the water are made from the platform while the engine is turned off so as to avoid any unforeseen accidents.

**CAUTION: Fiberglass deck can become slippery when wet.**

## PROPELLER PRECAUTION

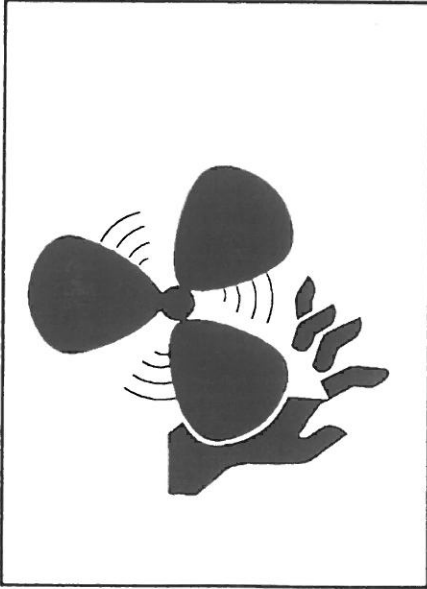

**!DANGER** Moving propeller will cause injury. Propeller may turn with boat in neutral. Shut off engine when people are on the platform or in the water near the platform.

## PROPELLER

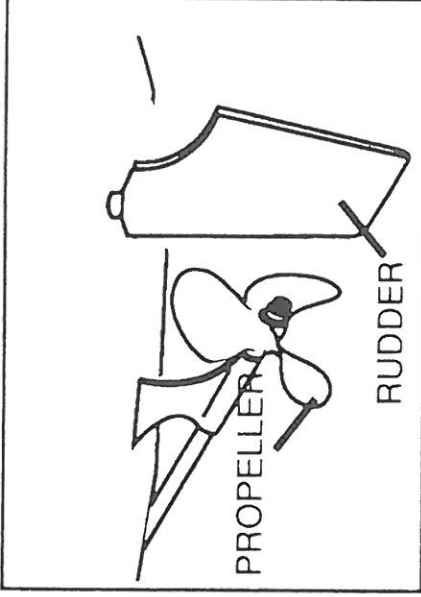

The research and design team at Moomba has carefully explored and tested several different types of propeller designs and pitch angles. All tests have indicated that the current propeller equipped on the Moomba is the best suited for the variety of boating needs required, ranging from competition skiing to a relaxing leisurely ride.

In general, changing the factory propeller to a low pitched propeller will increase acceleration and load ability, but will slightly decrease top speed.

Changing the factory propeller to a high pitched propeller may achieve higher top speed with a light load, while quick acceleration and power may decrease.

**NOTICE:** The maximum propeller/diameter size that can be used on the Moomba is 13".

**NOTICE:** Under no circumstances should a propeller which allows the engine to surpass recommended RPMs be used.



# INSTRUMENT PANEL AND CONTROLS - BOOMERANG

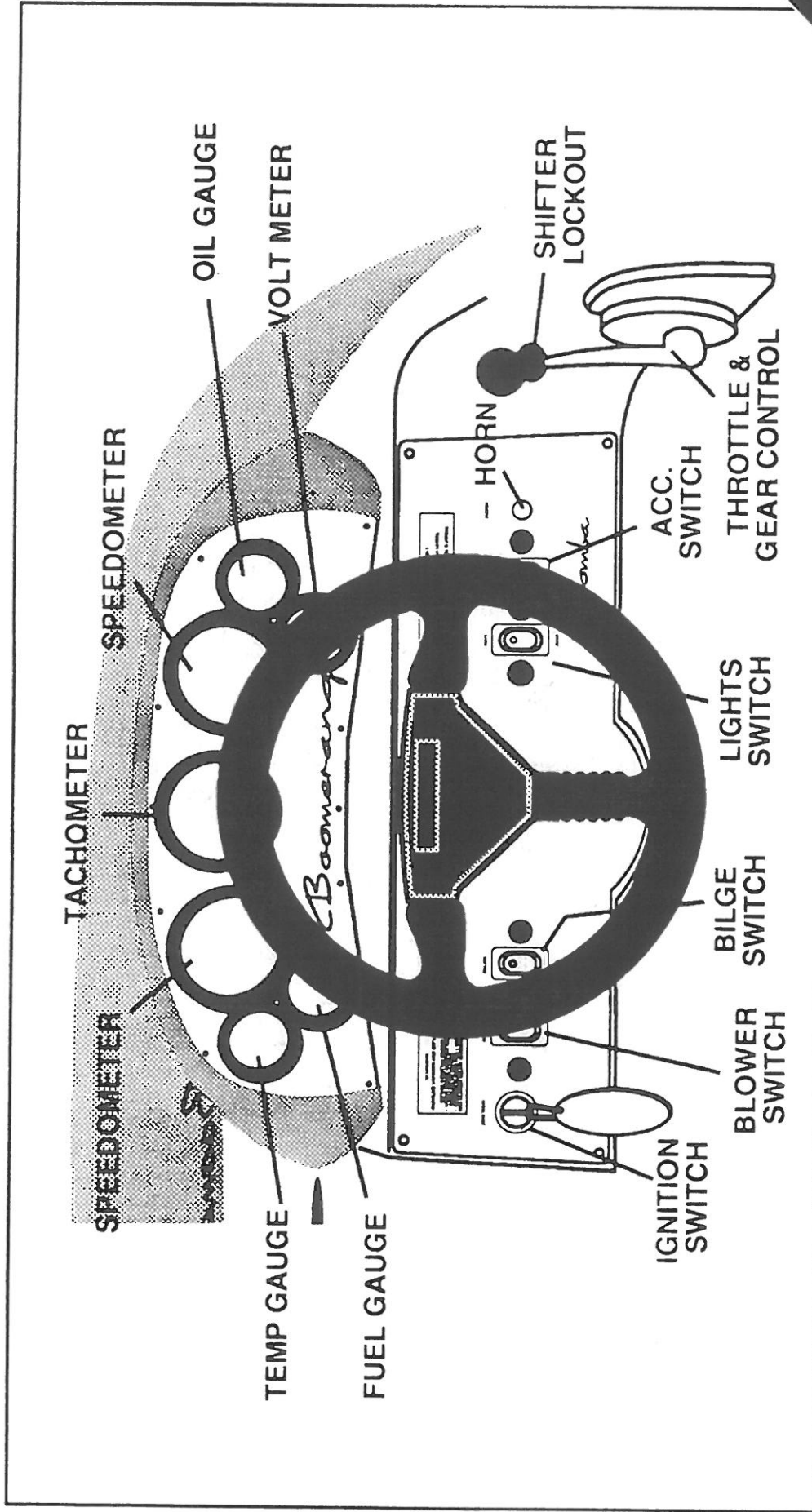

# INSTRUMENT PANEL AND CONTROLS – OUTBACK

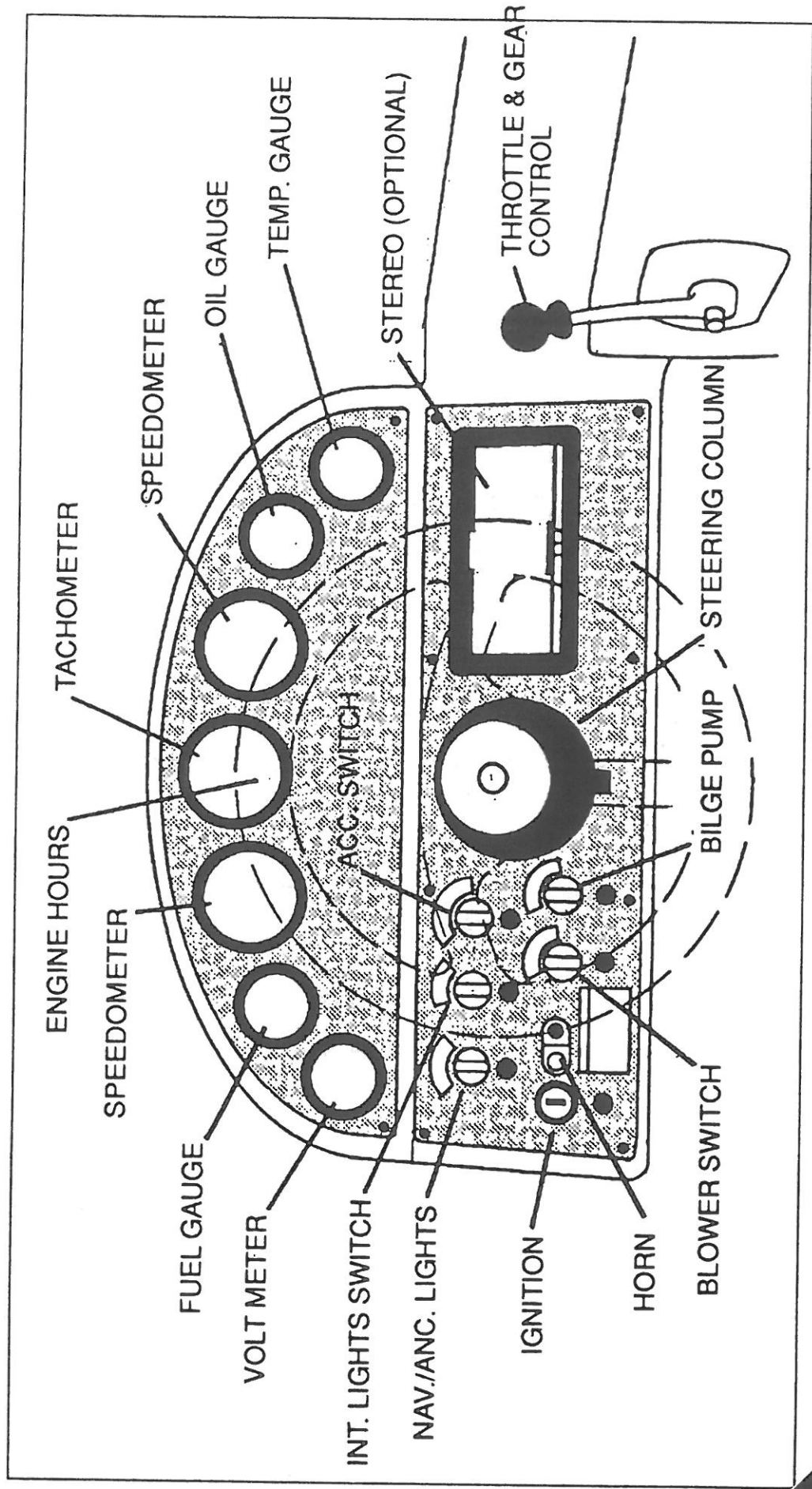

## SPEEDOMETER

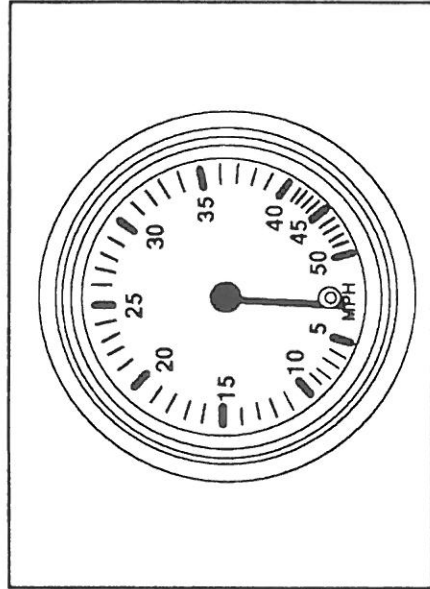

The speedometer indicates the accurate water speed of the boat in miles per hour. Speedometers may be calibrated using a stop watch and regulation slalom course.

## ENGINE HOURS

Outback models are equipped with hour gauge located at the bottom of the tachometer face.

The engine hour gauge acts as an odometer. Engine hours should always be noted and recorded so maintenance may be performed at proper intervals.

## TACHOMETER

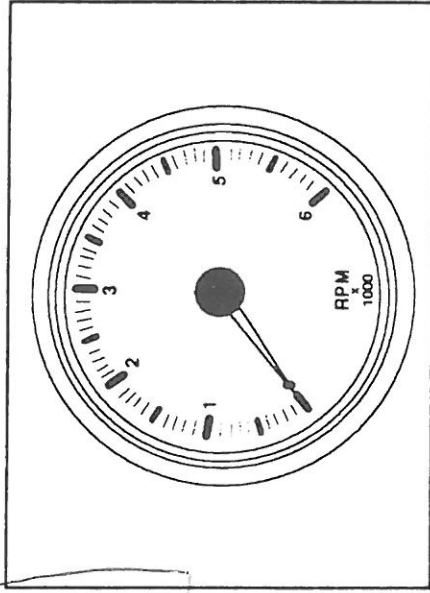

The tachometer registers the operating speed of the motor's shaft output in revolutions per minute. This output may be used as an alternative to a speedometer if weight and water conditions permit.

- **DO NOT** exceed the recommended RPM during break-in and normal operation of your motor. Exceeding the suggested RPM may cause damage to the engine.
- During tune-up and maintenance, use a dwell meter and RPM gauge to verify the dash RPM when setting your engine's idle speed.

## SLALOM COURSE SPEEDS:

MPH	TIME/SECS	+ / - 1/2 MPH	ALLOWABLE TIMES / SEC
30	19.3	19.0 - 19.6	
32	18.1	17.9 - 18.3	
34	17.0	16.8 - 17.2	
36	16.1	15.9 - 16.3	



## THROTTLE LEVER

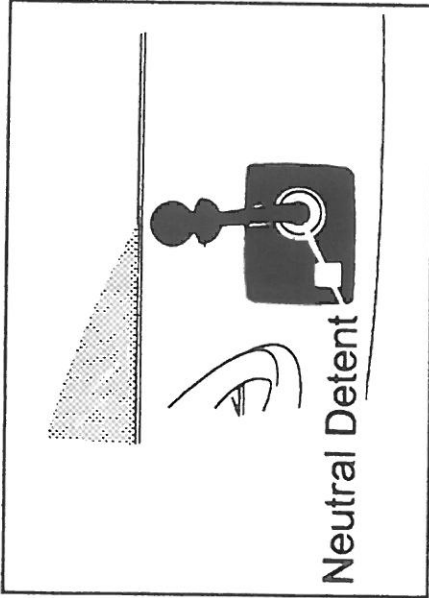

The throttle lever is located to the right of the instrument panel. To disengage the transmission, pull out the **Neutral Detent** button on the bottom center of the lever. This places the transmission into neutral and gives the throttle full range of motion without engaging the prop. Position the throttle vertically (in idle) before re-engaging the transmission by pushing in the Neutral Detent button.

- When engaging transmission from neutral to forward or reverse, lift the shifter lockout and move the lever slowly.

## SHIFTER LOCK OUT

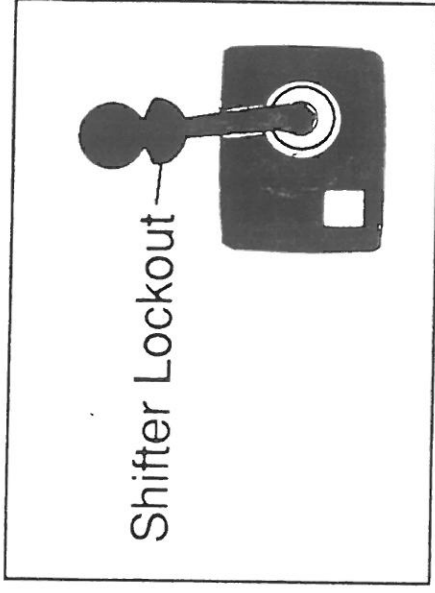

Shifter lockout must be depressed to engage transmission from forward to reverse.

- Never shift the lever directly from the vertical (neutral) position into a speed position.
- To prevent high torque engagement damage to transmission, slowly shift the lever into gear allowing transmission to engage, then accelerate the engine.
- Once the transmission is engaged, you may accelerate as quickly as safe operating conditions permit.

## IGNITION

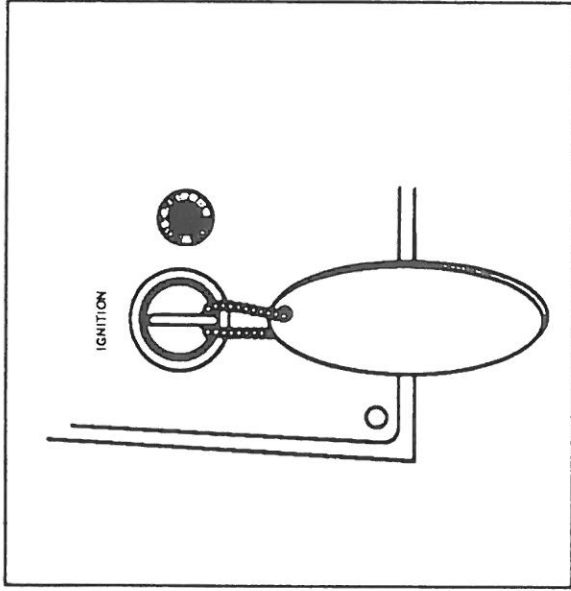

Located on the port side of the dash, the ignition switch has a three-position function.

Turn ignition one click to the right to check all electrical equipment, including blower, pump, and lights. Turn ignition all the way to the right to start the engine. The most vertical position insures that the ignition is OFF.

**All electrical equipment should be turned off when Moomba is in storage.**

## OIL PRESSURE

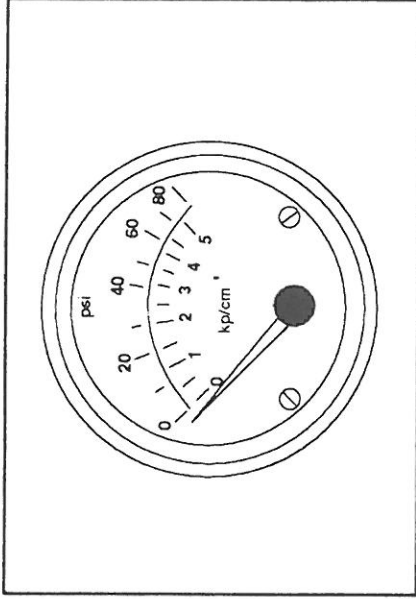

The oil pressure gauge indicates the oil pressure in the engine while the engine is running.

If the oil pressure remains below the normal range of 20-40 p.s.i., stop the engine immediately. If engine continues to run while oil pressure is low, permanent engine damage may occur.

## DIPSTICK

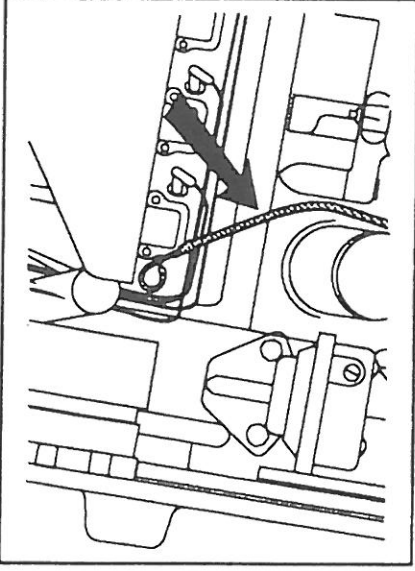

**NOTICE:** The oil pressure varies greatly with engine temperatures and speed. If oil pressure indication is too high or too low and will not increase when engine speed is increased, stop the engine immediately and check level of oil in engine using the level dipstick.

**NOTICE:** Continued engine operation while oil level is not normal may result in serious engine damage. Have the engine lubricating system checked as soon as possible.





## TEMPERATURE GAUGE

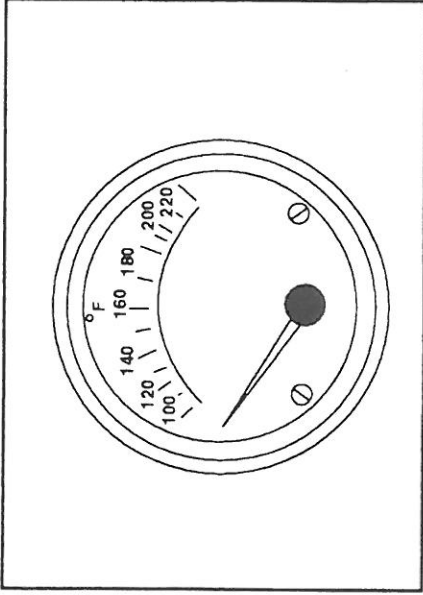

The temperature gauge indicates the engine coolant temperature while the coolant is circulating inside the engine. Engine operating temperature will vary depending on weather conditions and engine load.

## FUEL GAUGE

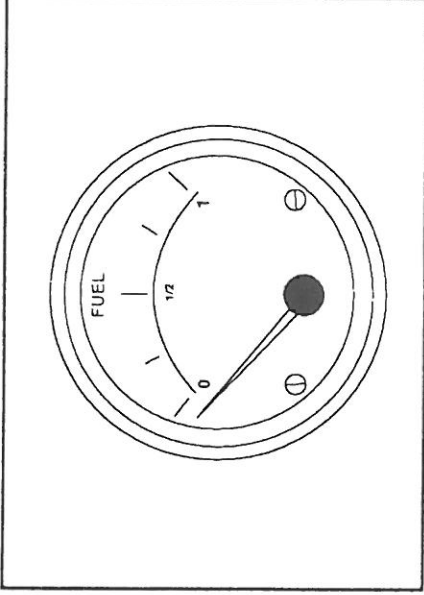

This gauge indicates the approximate quantity of fuel remaining in the tank when the ignition is in the "on" position.

**NOTICE: DO NOT** run the tank to empty. To prevent condensation from forming in the tank, it is recommended that the tank be filled when the gauge indicates 1/4 tank.

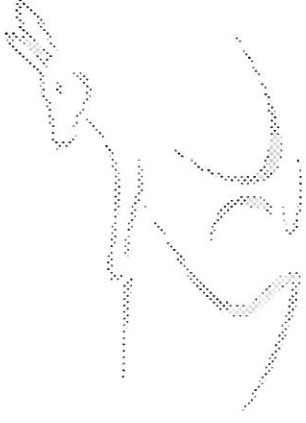

The following conditions may be considered normal operation of the fuel gauge and fuel system.

- Gas station pumps may shut off before the fuel gauge indicates 1 (FULL).
- The amount of fuel required for fill-up may not exactly correspond to the gauge.
- The needle may not move away from 1 (FULL) until some time after fill-up.
- The needle may move during turns, stops, and accelerations.

**NOTICE: Become familiar with engine hourly fuel consumption at various speeds and use as a backup check against fuel gauge readings.**

## BILGE PUMP/ BREAKERSWITCH

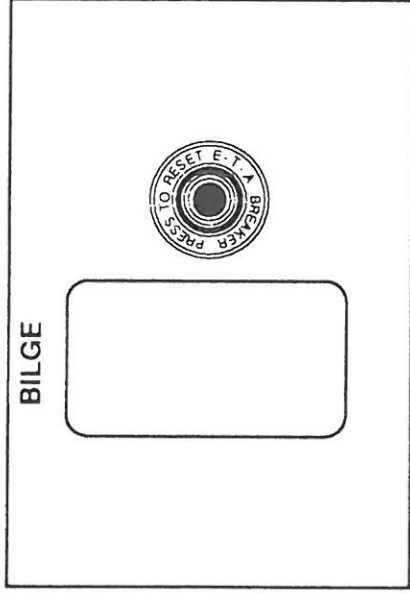

The manual switch is used to determine if the bilge pump motor is operating correctly. Press the top portion of the switch. Depressing the bottom portion of the switch engages the automatic function of the Bilge Pump.

If the bilge pump is working properly, the auto bilge pump function is engaged at all times so that any excess water in the bilge area may be drained out.

**NOTICE: If Bilge Pump fails to operate in the manual position, press the circuit breaker along side the switch.**

## IGNITION BREAKER

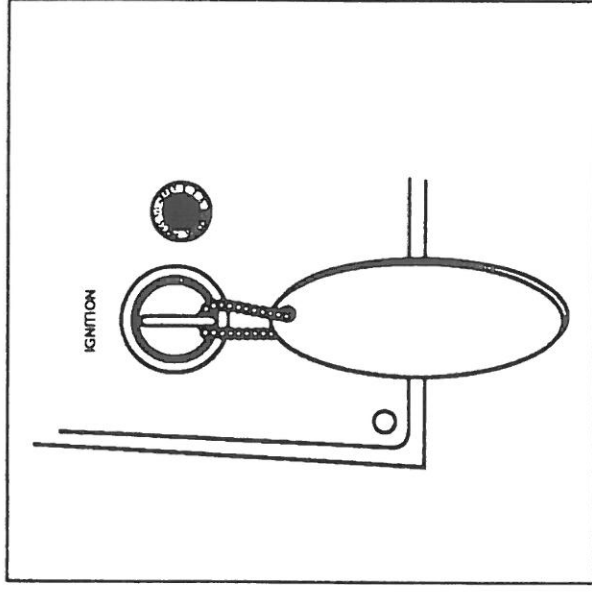

Located to the right of the ignition switch the ignition breaker deactivates all electrical equipment on board. This includes all instrumentation and lighting.

Push to reset.

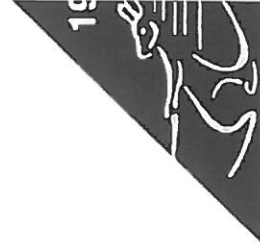

## BLOWER/BREAKER SWITCH

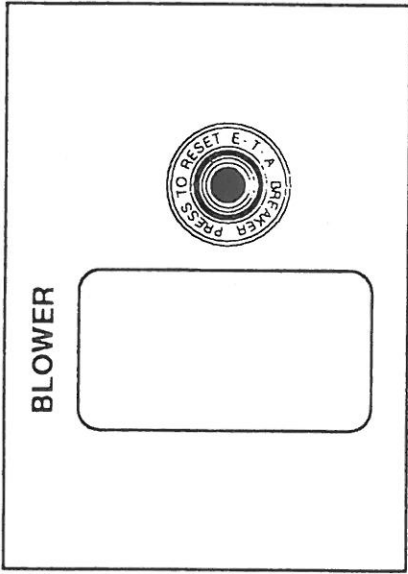

The blower switch will activate the blower motor located at the transom of the boat. The primary function of the blower is to eliminate any fumes in the bilge area and to supply a constant supply of fresh air to the engine. Never depend solely on the blower to eliminate dangerous fumes. Always open motor box to check if fumes are present.

Turn blower switch on a minimum of four minutes and check engine compartment before starting engine.

## VOLTMETER

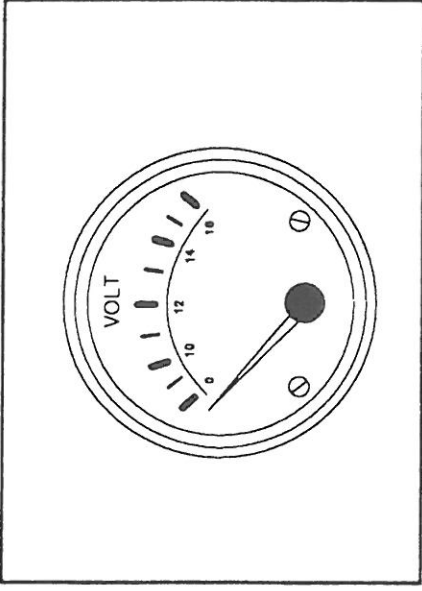

The voltmeter indicates whether the battery is charging or discharging. The needle should be located in the normal range while the engine is running.

If the voltmeter does not register in the normal range, there may be a problem within the electrical system.

It is normal for the voltmeter needle to fall below the normal range while starting the engine. Normal range is 12-14 volts.

**NOTICE:** If Blower motor fails to operate in the manual position, press the circuit breaker along side the switch.

**WARNING** DO NOT operate blower when refueling.



## NAVIGATION LIGHTS

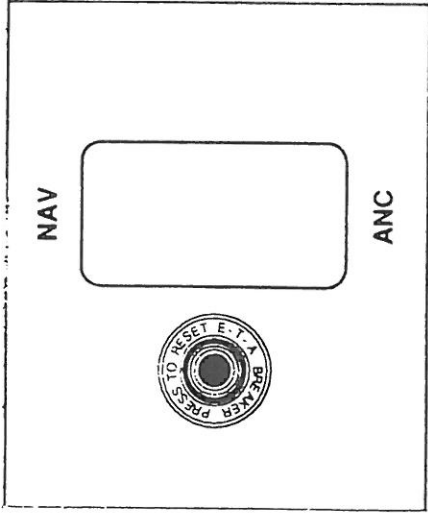

The navigation lights switch supplies power to the BOW LIGHT and the STERN LIGHT POLE.

NOTICE: If lights fail to operate, press circuit breaker re-set alongside the switch.

Press the lower side of the switch (ANC) to activate only the BOW LIGHT (ANCHOR POSITION.)

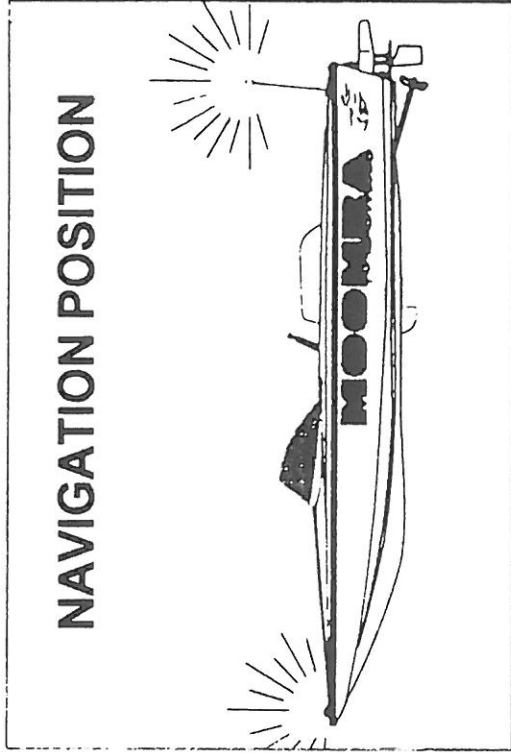

## NAVIGATION POSITION

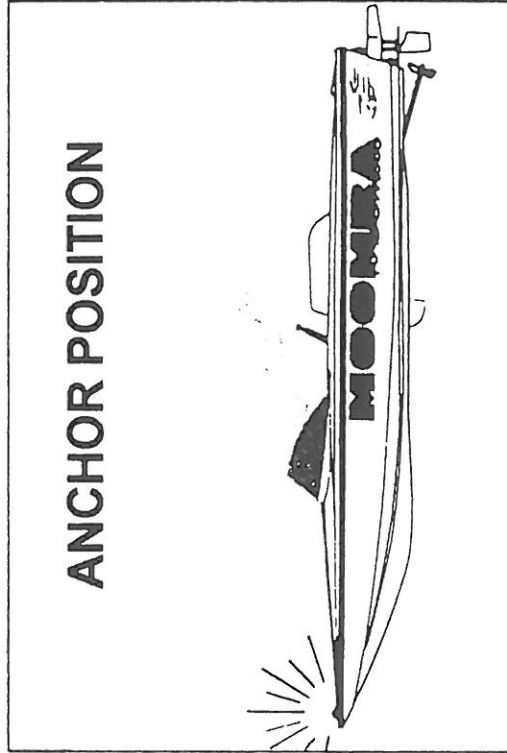

## ANCHOR POSITION

## ACCESSORY POWER

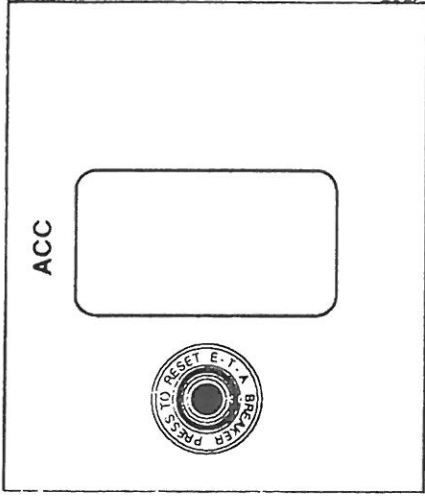

The accessory switch "ACC" supplies power to:

- Accessories added later.

NOTICE: If lights fail to operate, push circuit breaker alongside the switch.

Press the red indicator light at the top of the switch (NAV) to activate both the BOW LIGHT and the STERN LIGHT POLE (NAVIGATION POSITION.)



## HORN/BREAKER SWITCH

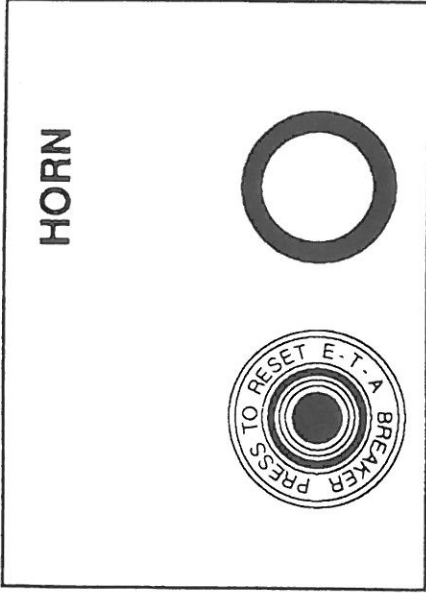

The horn button is located to the right of the steering wheel on the lower dash panel and is activated by depressing the button.

**NOTICE:** If horn fails to operate, depress circuit breaker next to the button.

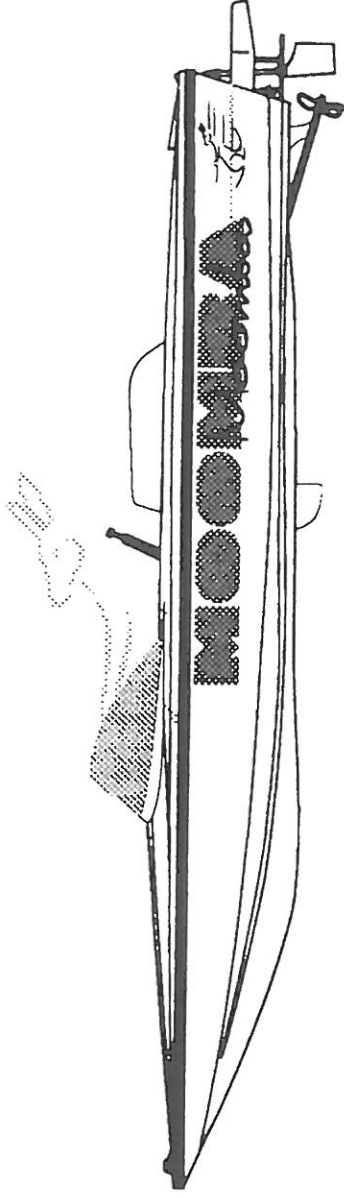

## HORN SIGNALS

### ONE LONG BLAST:

Warning signal (Coming out of slip)

### ONE SHORT BLAST:

Pass on my port side

### TWO SHORT BLASTS:

Pass on my starboard side

### THREE SHORT BLASTS:

Engines in reverse

### FOUR OR MORE BLASTS:

Danger signal

1. **OVERTAKING-PASSING:** Boat being passed has the right-of-way. KEEP CLEAR.
2. **MEETING HEAD-ON:** Keep to the right.
3. **CROSSING:** Boat on right has the right-of-way. Slow down and permit him to pass.





## BREAK IN

**DO NOT OPERATE AT SUSTAINED FULL THROTTLE DURING THE FIRST FIVE HOURS OF OPERATION.**

**DO NOT OPERATE AT HIGH RPMs IN NEUTRAL.**

After the engine is thoroughly warmed up, and the boat is under way, open the throttle wide until full RPMs are reached. (RPMs should cease climbing after 10 to 20 seconds.) **WARNING: SEE ENGINE MANUAL FOR MANUFACTURER'S MAXIMUM SAFE RPMs.**

Reduce throttle to 2,800 to 3,000 RPMs, and cruise at or below that speed for 1/2 hour. Reduce speed to idle, open throttle wide, and operate at that speed for approximately 1 minute; reduce to cruise throttle for a few minutes and repeat. (Bringing the engine from idle speed to full throttle will load the engine and assist in seating the piston rings.) This cycle can be repeated from time to time during the first 5 hours of operation, but full throttle should not be sustained for more than 1 to 2 minutes.

**FOLLOW THIS PROCEDURE ONLY WHEN CONDITIONS ARE SUCH THAT IT CAN BE DONE IN COMPLETE SAFETY.**

**DO NOT ATTEMPT TO BREAK IN AN ENGINE BY PROLONGED IDLING OR RUNNING AT THE DOCK.**

During the early part of the break-in period correct propeller selection can be confirmed. With a normal load aboard, the engine RPMs should reach, **BUT NOT EXCEED, maximum RPMs RECOMMENDED BY MANUFACTURER** (see engine manual.)

During the break-in, the Temperature Gauge should be watched carefully, and speed reduced if overheating becomes evident. (For further information refer to engine manual.)



## STARTING AND OPERATING

A routine pre-starting procedure should always be carried out before the first startup of the day.

1. Check oil in engine.
2. Inspect sight tube of fuel pump.
3. Check for gasoline fumes in bilge or engine compartment.
4. Operate engine blower for four minutes to remove any fumes.
5. Operate bilge pump until bilge is dry.

Other items to be inspected may exist, depending on the nature of the boat. It is advisable to formulate a check list containing all items relative to the boat, and follow it faithfully. **REFER TO BOATMAN'S CHECKLIST LOCATED NEAR THROTTLE CONTROL.**

Consult the local Coast Guard Auxiliary or Power Squadron for full details on boating safety.

**NOTE:** Other accessories should not be connected to the ignition terminal or ignition circuit. The engine is equipped with an automatic choke which is opened by an electric heating unit. If the ignition is on for 1 or 2 minutes prior to starting, the choke will be open and inoperative, and starting may be extremely difficult.

**IMPORTANT: DO NOT** continue to operate starter for more than 30 seconds without pausing to allow starter motor to cool off for 2 minutes. This also will allow battery to recover between starting attempts.

(For further information refer to engine manual.)

## BEFORE STARTING, BE SURE THE SHIFT SELECTOR IS IN NEUTRAL.

Models equipped with PCM transmissions, Warner Velvet Drive transmissions, or Warner Vee Drives, have a factory installed safety switch incorporated, which prevents actuation of the starter unless the shift selector is in neutral. Other models may not. Before starting a cold engine, pump the throttle two or three times from closed to open to closed. Open throttle slightly above the idle position, and actuate starter. As soon as the engine starts, return the throttle toward closed to establish the engine speed at 1,200 to 1,600 RPMs, and give the engine a short period to warm up and smooth out. When all else is in readiness, reduce speed to idle, shift into gear, and proceed normally.



## TRAILERING

Moomba trailers are designed especially for Moomba boats. It is important to remember the following guidelines to prolong the life of the boat and trailer.

1. Adjust weight of boat on the trailer so that it is correctly distributed on the trailer hitch.
2. It is recommended to secure boat to trailer with tie downs.  
**IMPORTANT: DO NOT use straps around any fender or light mounting locations.**
3. Check trailer manual for correct tire pressure. Under-inflated tires may cause blowouts, trailer sway, or tire wear.
4. Refer to trailer manual for recommendations on maintenance, safety, and operational procedures.

**NOTICE:** Any questions may be answered by referring to the trailer manual or the manufacturer.

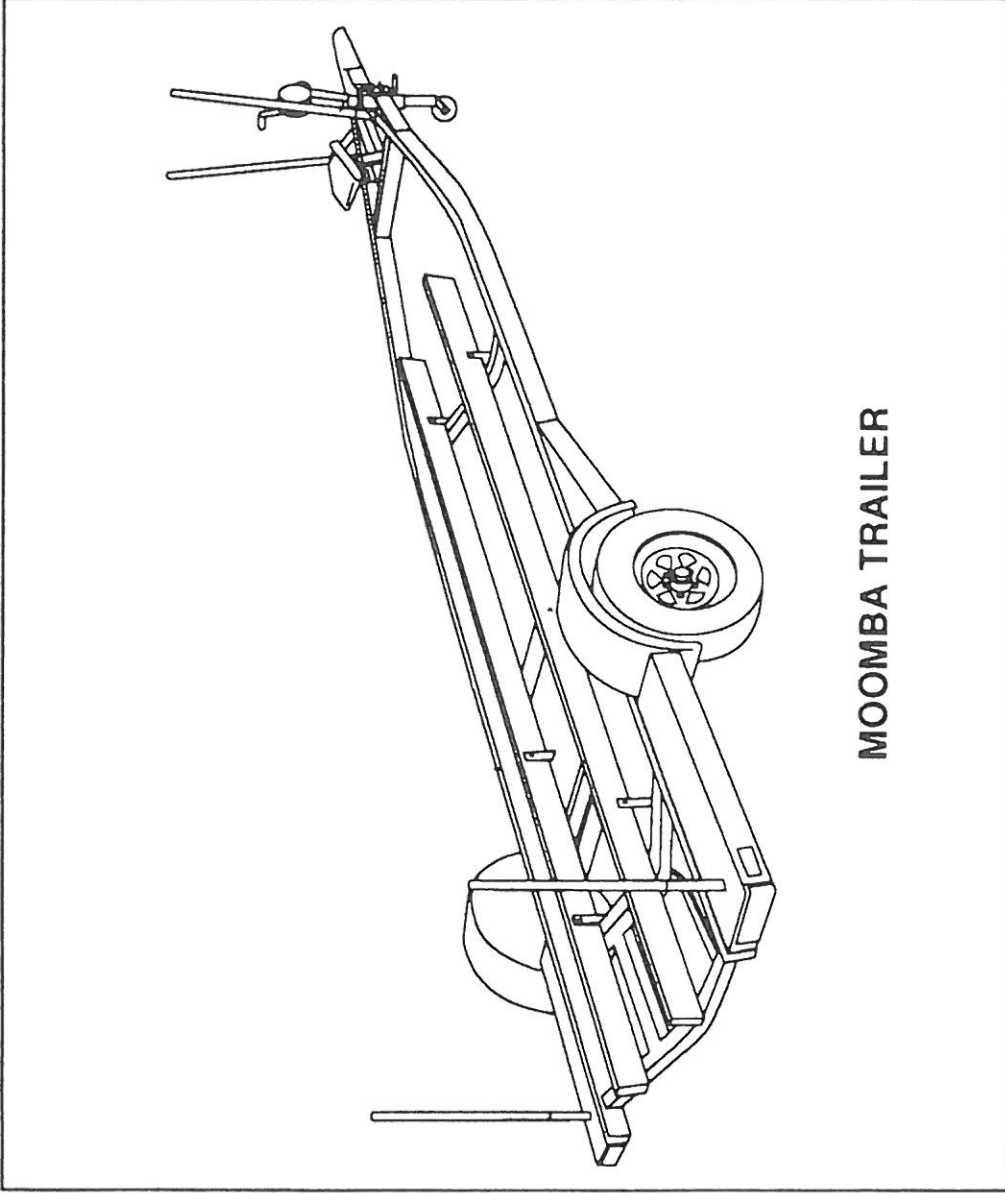

## UNLOADING PROCEDURE

To unload the boat use the following procedure as a guide:

1. Make sure that all drain plugs are securely in place.
2. Unplug all light cords before backing trailer into the water.
3. With Bow Eye Hook fastened, back the trailer until the water is approximately one inch under the top of the trailer fenders.

**NOTICE: Ramp slopes vary, so actual position of water may be slightly different.**

4. Follow the cold start procedure recommended in the engine manual.
5. After starting the engine, remove BOW EYE HOOK.

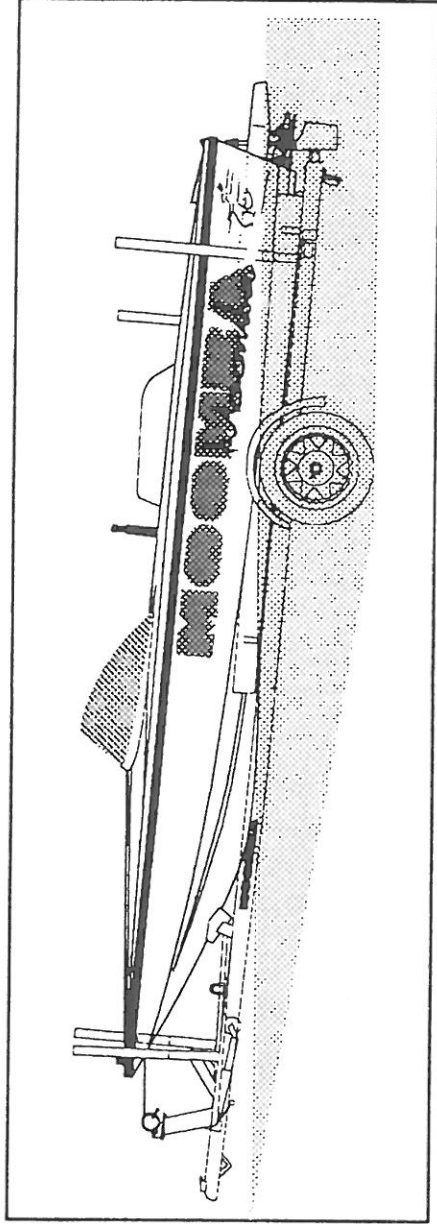

**NOTICE: Do not rapidly move throttle in order to free boat from its dry carpet runners. If the trailer is not submerged to the correct depth, the nose of the boat will dip drastically once it has freed itself from the height of the runners, possibly damaging**

6. With engine idling, center steering wheel, engage transmission, and slowly place throttle in reverse. Ease back on the throttle lever until the boat starts to move. (Because your Moomba is a direct drive inboard, the stern will have a tendency to drift left or right depending on propeller rotation while backing off the trailer. This condition will self-correct as the rudder reaches control speed.)

**NOTICE: Before operating your Moomba refer to the Daily Check List and the BOATMAN'S CHECK LIST (page 2.)**



## LOADING PROCEDURE

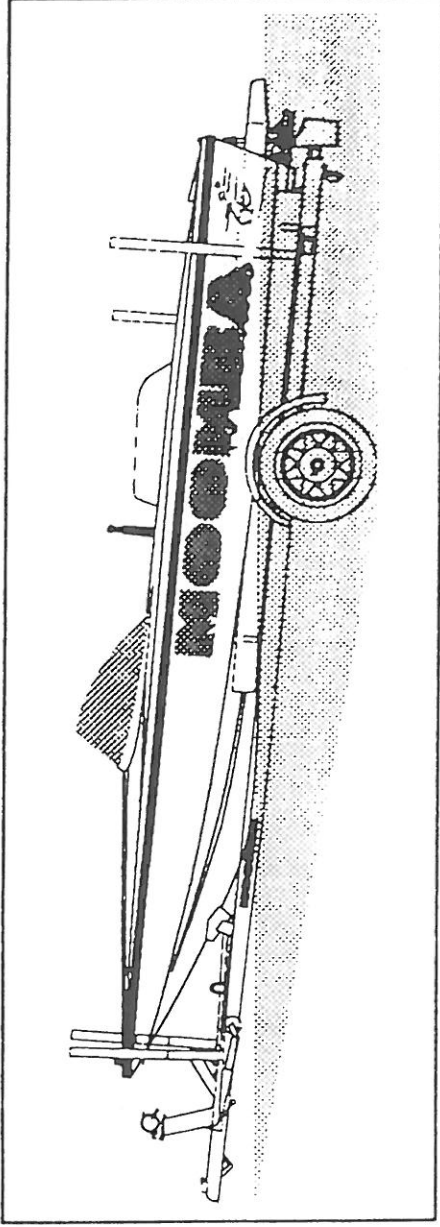

To re-trailer the boat, position the trailer in the water with approximately one inch of the top of the fender showing (as in step 2. UNLOADING) Please try to idle coast onto the trailer.

**DO NOT power onto the trailer during rough conditions.**

On the trailer are vertical guide poles that site the course of the boat as it moves into position. When correctly positioned on the trailer, power up slowly within 1/2" of the guide poles. Use the Hook and Winch to pull the boat tight against the guide poles.

## BOAT HOOKUP

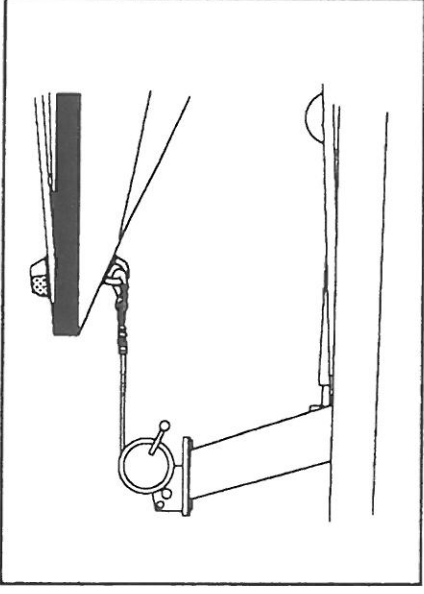

It is important that the boat is securely in place before moving trailer.

- Secure trailer hook to bow eye and tighten up winch firmly.
- Check winch lever for secure placement.
- Refer to trailer manual if needed.

## TRAILER ALIGNMENT

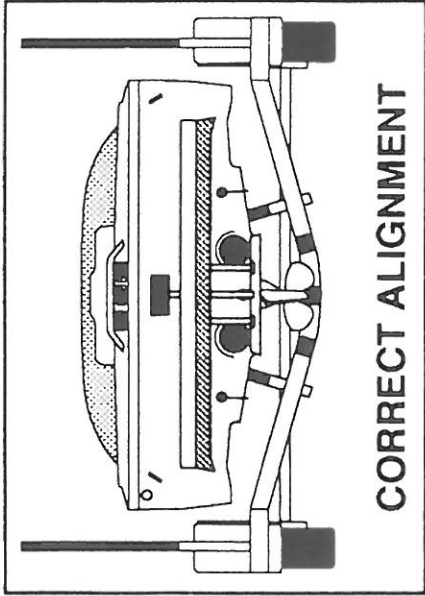

When pulling boat onto trailer, be sure the boat is centered as much as possible on the trailer.

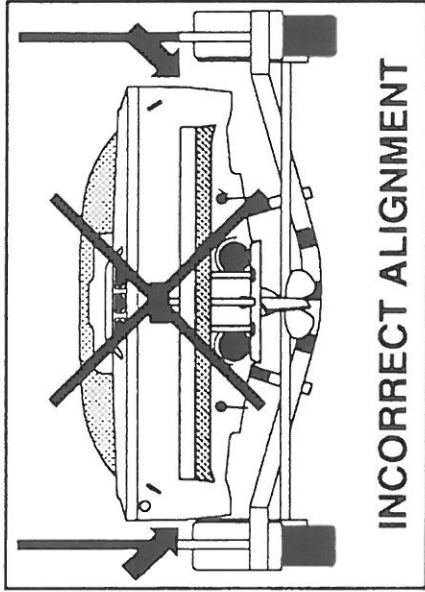

The distance between boat and runner board should be approximately equal on both sides.

## BILGE AREA DRAIN PLUG

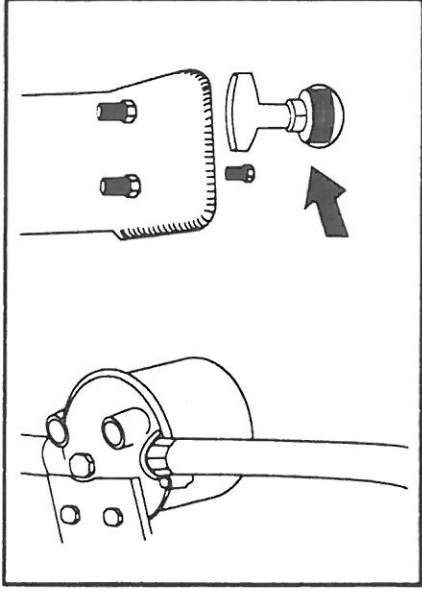

The bilge area drain plug is located at the extreme front of the motor well, directly in the center of the well under the engine. It is extremely important that the drain plug is always checked before starting the engine. The drain plug should be secured in place using a wrench.

**! CAUTION** DO NOT start engine until center drain plug is checked and secured in place. DO NOT try to install center drain plug while engine is running.



## HOISTING

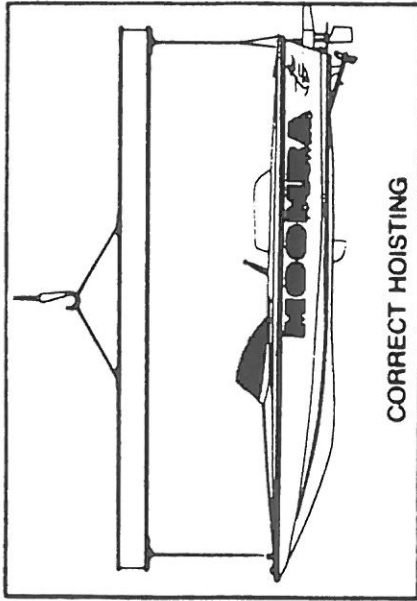

If there comes a time to remove the boat by some means other than the trailer, special attention should be given to the following recommendations.

- Hoist the boat using a vertical lifting bar only (as shown in diagram).
- Operator should slowly and smoothly raise the boat from the water without any harsh jerking so as not to damage the lifting eyes or stern eyes.

It is recommended to use a clevis pin and clevis for the lifting eyes since hooks tend to round the surface and damage plating on the lifting eyes.

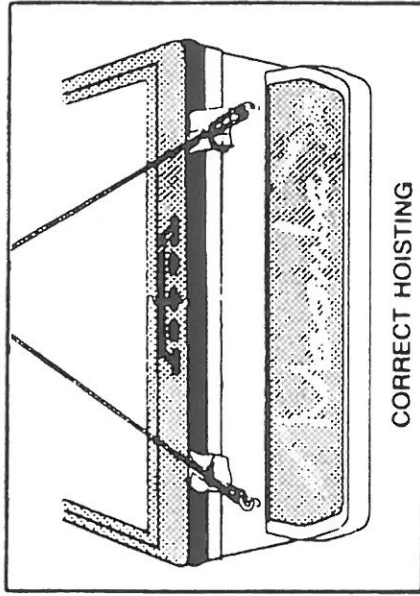

- DO NOT use the ski bar to hoist the boat.

**WARNING: Improper hoisting may violate warranties and guarantees on the boat.**

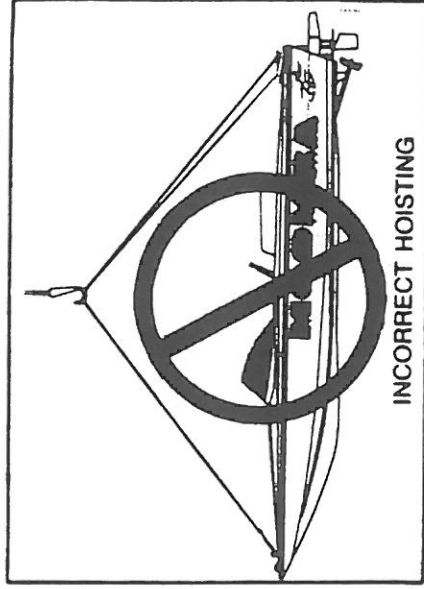



## DRY STORAGE

When the boating and ski season comes to a close, it is recommended that the boat be removed from the water and stored for the winter months. It is extremely important that the correct winterizing procedures are read and followed to insure longer boat life.

### 1. Engine preparation

- a. Drain all water from engine cooling system by removing engine drain plugs (refer to engine manual).
- b. Reinstall all engine plugs and remove transmission intake hose. Inspect intake for any debris and remove if necessary.
- c. While engine is running, have another person slowly pour one gallon of antifreeze into intake hose. Upon completion, and after antifreeze has circulated through engine, turn ignition off.
- d. Once again, remove all engine drain plugs and drain out antifreeze. Store drain plugs in a safe place.

**NOTICE:** This procedure will coat the inside of the engine's cooling system to prevent any damage due to freezing.

2. Remove hull drain plug and store in a safe place.

3. Clean boat interior and exterior thoroughly. Inspect boat hull for any residue or algae growth and remove if present.

4. Clean bilge area thoroughly and operate bilge pump to remove any water from the bilge lines.

5. Remove all seat cushions and open all storage areas to air out boat interior. Replace cushions and close storage areas after interior is completely dry. This will prevent mildew from forming while boat is in storage.

6. Top off fuel tank to prevent any condensation from accumulating in fuel system.

- If water is present in fuel system, add a commercial dry gas product to fuel in the recommended amounts.

7. If boat is stored on a trailer, inspect boat's positioning so that it is resting correctly. If possible, raise the bow above the stern to allow any moisture to drain out.

8. Install canvas cover and secure straps properly (refer to canvas cover installation).

**REMEMBER:** During the winter months, water is a boat's worst enemy. Always store boat after interior is completely dry and periodically check the condition of the boat.

## COAST GUARD REGULATIONS

The United States Coast Guard boating regulations prescribe minimum standards of safety, and it is necessary that your boat remain in compliance with these regulations.

## SAFETY PROCEDURES AND EQUIPMENT

The following equipment should be on board your Moomba at all times:

- An approved hand-held fire extinguisher (provided by Moomba).
- At least one Coast Guard approved PFD (personal flotation device) for each person aboard.
- At least one approved throwable device (ring buoy or buoyant cushion).
- One hand-, mouth-, or power-operated whistle or horn audible for at least one mile.
- Signal flares should be carried by boats going offshore.
- In addition, it is recommended that you carry an anchor, anchor line, tie-up liner, fenders, first aid kit, waterproof flash light, distress flares, and electrical tape.

## MAXIMUM CAPACITIES

**MAXIMUM CAPACITIES**

**5 PERSONS OR 680 LBS.**

1400 POUNDS PERSONS, GEAR

THIS BOAT COMPLIES WITH U.S. COAST GUARD SAFETY STANDARDS IN EFFECT ON THE DATE OF CERTIFICATION  
MANUFACTURER: United Marine Corporation of Tennessee  
MODEL 18' SERIES Maryville, TN

**PLEASE DO NOT EXCEED THESE LIMITS. ALWAYS WEIGH IN. WEIGH BELOW DECK. NEVER RESPONSIBLE FOR PRODUCTION CONTROL.**

LOAD CAPACITY \* COMPARTMENT VENTILATION STEERING, FUEL AND ELECTRICAL SYSTEMS INTERNATIONAL LIGHTS \* BASIC FLOTATION MANEUVERABILITY

NATIONAL MARINE MANUFACTURERS ASSN



In compliance with Coast Guard regulations, Moomba boats meet or exceed all safety standards designed for recreational boats.

To insure safe handling and performance, all Moomba boats display a maximum capacity sticker. This sticker displays the maximum passenger and weight load allowable for that your boat.

**NOTICE:** Refer to the Maximum Capacity Sticker on your boat for allowable loading.



## CANVAS COVER

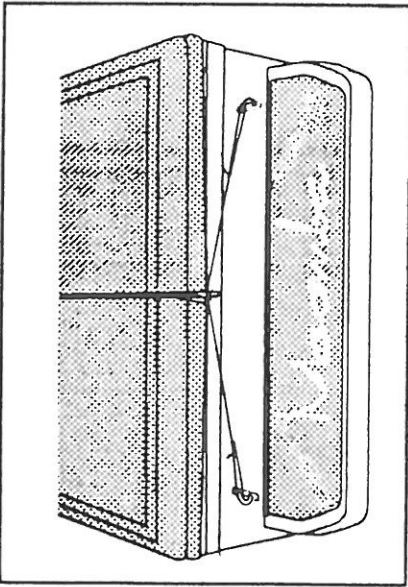

Moomba uses only the finest quality canvas material and strapping to insure all Moombas stay clean and dry in the off season.

All canvas covers have been specially designed to fit securely around each Moomba boat. If the cover does not fit as tightly as expected, this is due to shrinkage after the cover has become wet.

## FOLDING COVER FOR STORAGE

When folding cover for storage, remove excess water and store in a dry location. Do not allow cover to touch any concrete or rough surfaces which may scratch the canvas finish.

If any abuse or damage occurs, immediately patch or seal the area. Moomba recommends using tent seam sealer for any seam damage and a fabric guard for any surface damage.

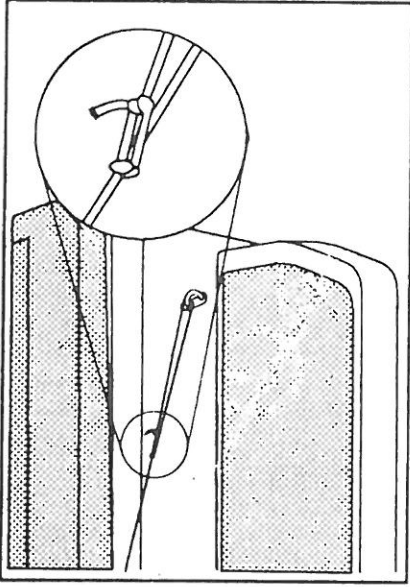

To cover the boat:

1. Be sure the cover fits snugly at the nose of the boat and then unfold from front to back.
2. Secure all fastening straps around trailer frame.
3. Pull rear pinch cord and tie off according to the diagram.

Canvas tears should be patched professionally and threads sealed to prevent leakage.



# SERVICE & MAINTENANCE

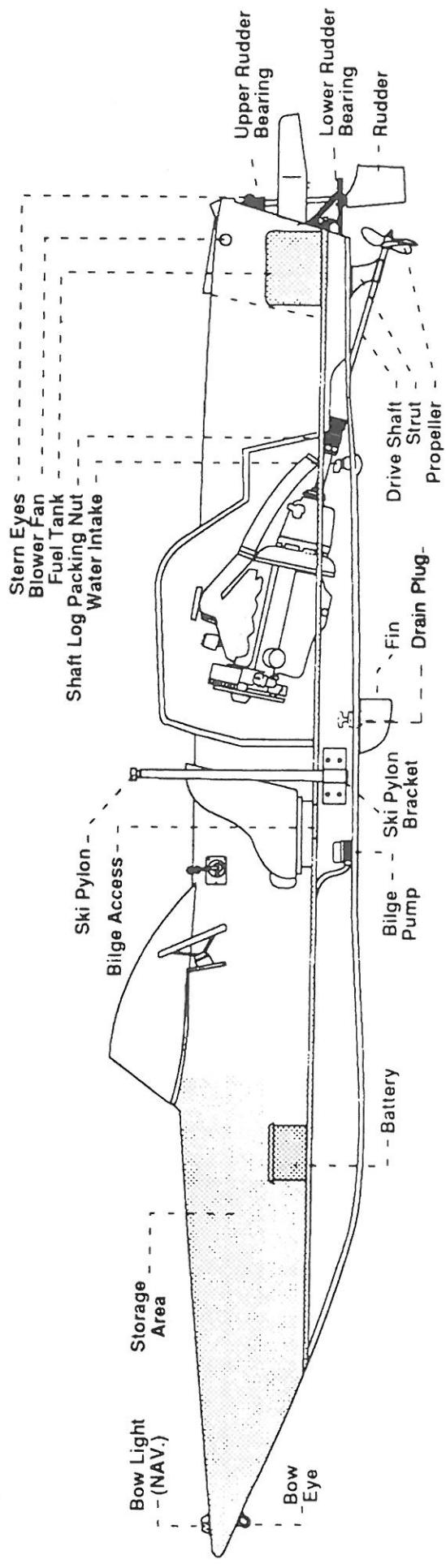
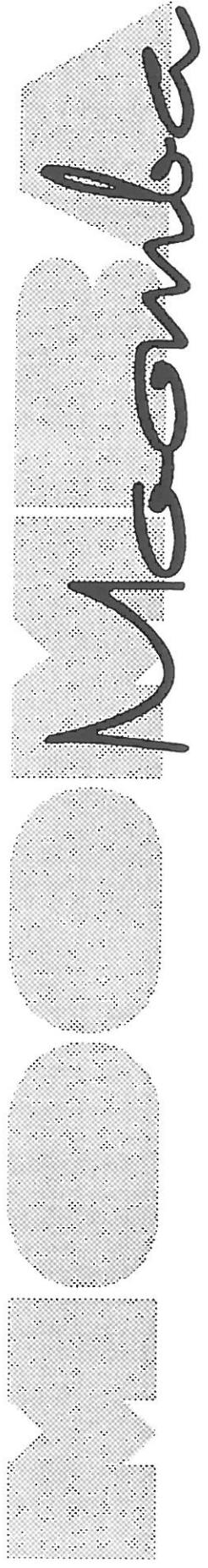

The above illustration denotes the areas that may require cleaning, repair, or maintenance. It is important to have a basic understanding of mechanics and locations. However, it is recommended that any service beyond standard maintenance be performed by an authorized Moomba dealer.

# Maintenance Chart

Maintenance Intervals in Engine Hours

	Weekly	1st 25 Hrs.	50 Hrs.	100 Hrs.	Yearly
Change Engine Oil					Yearly
Replace Oil Filter					
Clean Oil Filler Cap					
Check Transmission Fluid Level					
Change Transmission Fluid					
Check Sea Water Strainer	*	*	*		
Clean Flame Arrestor					
Clean Crankcase Ventilating System					
Check Water Pump and Alternator Belts for Tension					
Change Fuel Filter					
Check Fuel System Lines and Connections for Leaks					
Clean Carburetor Fuel Inlet Filter					
Clean Transmission Oil Strainer Screen					
Lubricate Distributor Cam					
Inspect Breaker Points					
Check Condition of Spark Plugs					
Check Battery Electrolyte Level					
Check All Electrical Connections					
Check Cooling System Hoses and Connections for Leaks					
Tighten Engine Mount Fasteners					
Lubricate Throttle and Shift Linkage Pivot Points					
Check for Loose, Damaged, or Missing Parts					
Check Engine to Propeller Shaft Alignment					

\* If engine overheats, visually check. If clogged, clean out.

This inspection and maintenance schedule is based on average operating conditions in normal service. Under severe operating conditions, intervals should be shortened.



## SERVICE AND MAINTENANCE

For your convenience, a maintenance schedule has been included in this manual. The items listed should be performed at regular intervals as indicated by shaded boxes. Engine hours or time interval determine when service is necessary.

It is recommended that any replacement parts used for maintenance or for repair be supplied by an authorized Moomba dealer.

**NOTICE: You are responsible for keeping maintenance records on your Moomba should you be required to prove that required maintenance was performed.**

## ENGINE OIL AND FILTER

Crankcase oil should be selected to deliver the highest performance under weather and operating conditions present in operating area. In general, engine oils with low viscosity ratings are used when temperatures remain low or when better fuel economy is desired. Oils with high viscosity are used when temperatures remain high and when high performance is expected from the engine.

It is recommended that 10W-30 or 20W-40 or other high grade automotive oil with correct viscosity be used. All oils should have an A.P.I. classification of "SF".

(Refer to lubrication chart.)

## FUEL FILTER

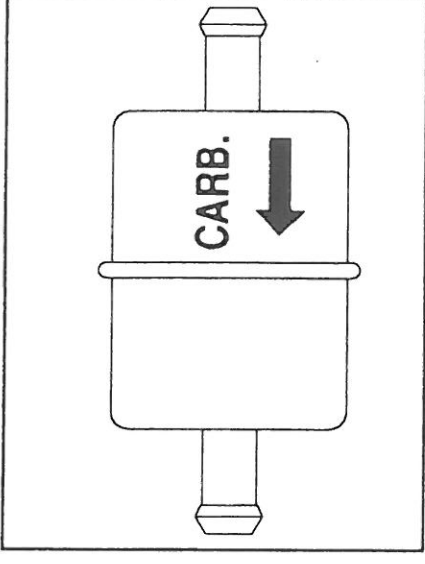

The fuel filter is mounted at the extreme front of the motor well.





## COOLING SYSTEMS

### FRESH WATER COOLING SYSTEMS

This is an open circulating cooling system which is preferred for lakes and water reservoirs with low salt content; however, when engine is operated in salt water, the system should be flushed with fresh water periodically and before storage.

### SALT WATER COOLING SYSTEMS

This is a closed cooling system with a solution of 50% antifreeze and 50% fresh water. This solution should be left in the system and replaced once a year as an annual maintenance item.

## BODY LUBRICATION

Normal use of your Moomba causes metal-to-metal movement at various points within the boat. If not properly lubricated, improper operation and wear may result. For body parts which require lubrication, a dripless oil may be used, although any lubricant should be used sparingly. Following application, excess lubricant should be carefully wiped away.

Driver seat track may be lubricated with a water resistant chassis lubricant.

## SHAFT LOG PACKING NUT

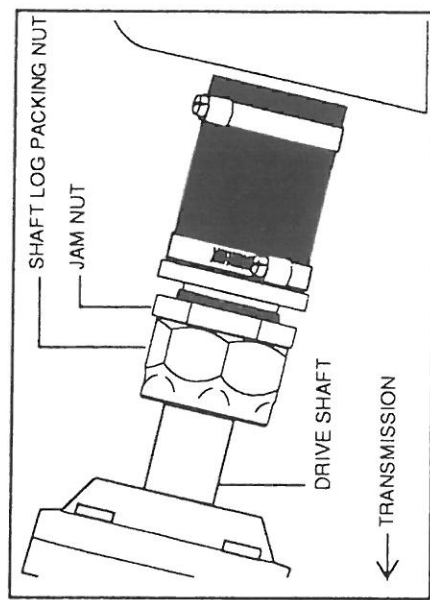

The Shaft Log Packing Nut should be checked periodically and adjusted if needed. To adjust:

1. Loosen the jam nut approximately 5 to 6 turns.
2. Tighten the large packing nut until hand tight. **DO NOT** overtighten.
3. Retighten the jam nut against the packing nut.
4. Check for leaks.

**NOTICE: It is normal for the Packing Log Nut to drip at a rate of 15 to 30 seconds between drips.**





## OIL LEVEL CHECK

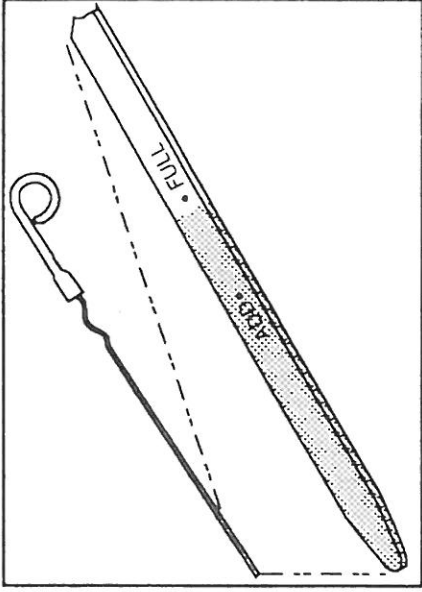

Engine oil level should be checked at regular intervals (such as every 5 engine hours). To obtain a true reading, when the engine is at operating temperature and turned off, check the oil on the level dipstick.

Pull out the level dipstick, wipe it clean, and re-insert it all the way down or the reading will be incorrect. Pull out the dipstick again and note the position of the oil.

If the oil level is between the "FULL" and the "ADD" marks on the level dipstick, simply re-insert it. If the oil level is below the area marked "ADD," add oil up to the "FULL" mark immediately.

## TRANSMISSION

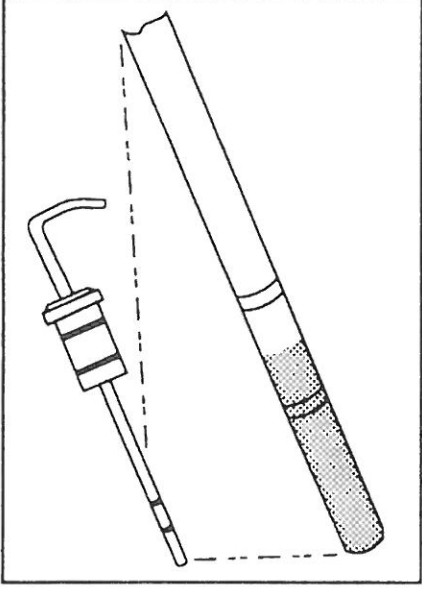

4. Wipe fluid from dipstick and set in position in transmission fill hole.
5. Remove and note level indicated on dipstick. Add fluid if required to bring level up to the top mark.
6. Check the dipstick fluid level a second time to verify level.
7. Replace dipstick.

## CHANGE FREQUENCY

Change transmission fluid once each year. (See Engine Owner's Guide.)

## MAINTAINING TRANSMISSION FLUID LEVEL

Transmission fluid level should be checked frequently and fluid added if necessary. The level must be maintained between the two marks on the dipstick.

## TRANSMISSION FLUID TYPE

Use only Dexron automatic transmission fluid type "A" 1:1 drive train with Warner gears. PCM 1:1 uses 20-20W motor oil grade SF/CD.

## MAINTAIN FLUID LEVEL AS FOLLOWS:

1. Boat must be at rest.
2. Engine should be at operating temperature but turned off while checking level.
3. Pull dipstick handle and remove dipstick.



# BATTERY CABLE INSTALLATION AND PRECAUTIONS

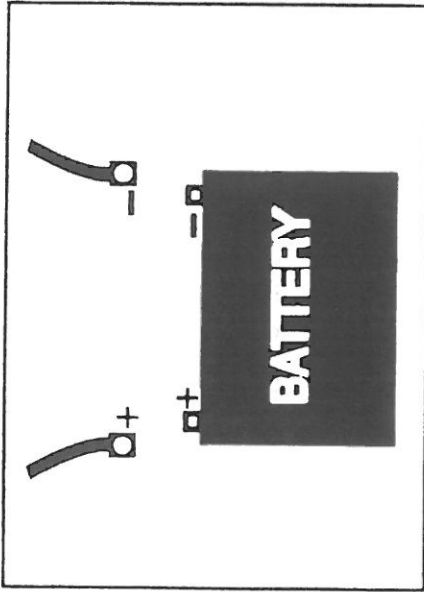

1. Connect negative (-) battery cable to ground on engine.
2. Connect positive (+) battery cable to the starter solenoid.
3. Connect positive (+) battery cable to positive (+) post on battery and negative (-) battery cable to negative (-) post on battery.

**! CAUTION** Engine electrical system is negative ground. Failure to connect battery leads as outlined will damage the system.

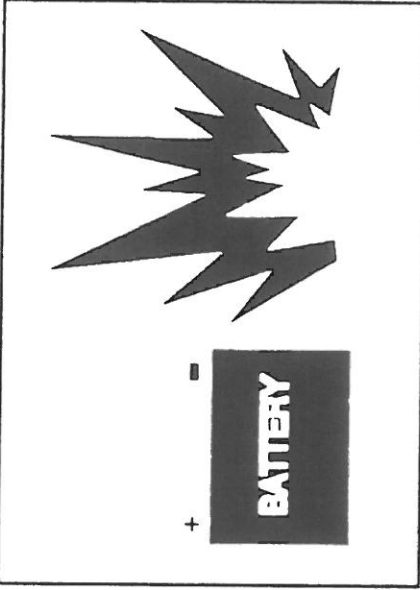

**! WARNING** Hydrogen and oxygen gases are produced during normal battery operation or charging. Sparks or flames can cause the mixture to ignite and explode if it comes near the vent openings.

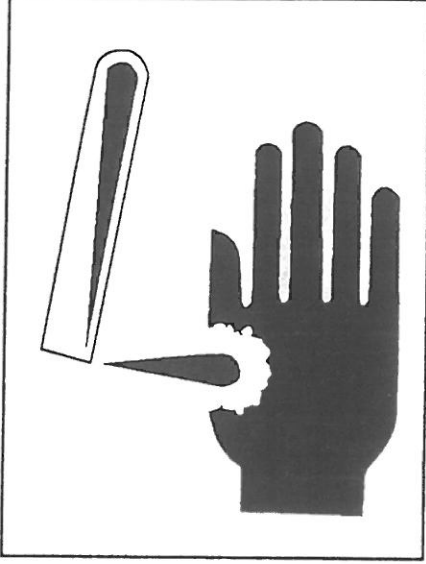

**! WARNING** Sulfuric acid in the battery can cause serious burns. If spilled on skin or in eyes, flush with clear water immediately.

## FIBERGLASS CARE

Caring for a Moomba boat is a general responsibility for all owners. Washing and waxing the boat hull and deck on a regular basis may extend the life and beauty of the Moomba.

All Moomba boats are constructed of a composite of differently structured fiberglasses combined with an outer layer of gelcoat. This gelcoat gives all Moombas a shiny and smooth surface. It is good practice to rinse the Moomba with fresh water after each day's use.

It is recommended that the boat hull and deck be waxed after every 50 hours of use to decrease water friction and to lessen the potential for staining or spotting of the gelcoat surface.

In cases where the original gelcoat shine cannot be restored by waxing, the shine should return by hand buffing using any commercial polishing compound. Be sure to apply a new coat of wax containing Car-nauba over the area that has been polished.

**IMPORTANT:** Porcelain cleaning powders are too harsh on the gelcoat surface and will permanently discolor the gelcoat if used.

Household detergents containing ammonia or chlorine should not be used.

Never use acetone or ketone solvents.

## WASHING YOUR MOOMBA

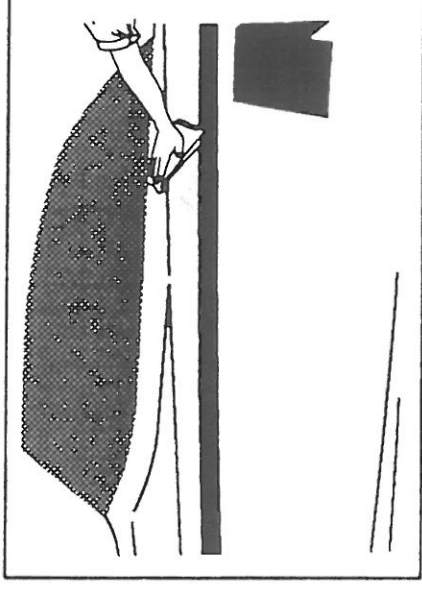

The easiest way to preserve the beauty of your Moomba is to keep it clean by frequent washing. Wash the boat in lukewarm or cold water. Wipe the boat down immediately to avoid water spots.

Avoid using hot water or washing your boat in direct sunlight. Avoid strong soaps or chemical detergents. All cleaning agents should be rinsed from the surface promptly and not allowed to dry on the finish as they will cause spotting to occur.



## WASHING AND WAXING RUB RAIL

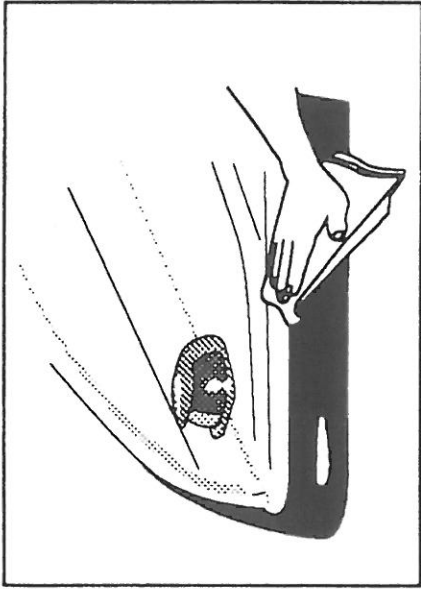

Use a sponge or other soft material to wash and wax the rubber rub rail.  
To wax, use a commercial automotive black bumper wax.

## UPHOLSTERY CLEANING

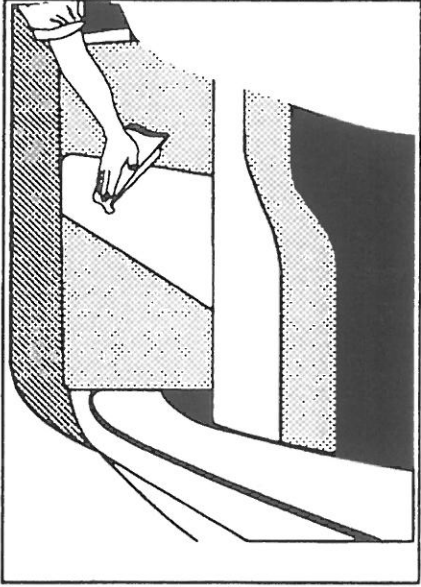

All upholstery items aboard the boat are made of tough marine vinyl that is easily cleaned with a mild detergent or any automotive vinyl cleaner.

**CAUTION: Strong detergents and cleaners may shorten the life of the vinyl. SEE VINYL MANUFACTURER'S RECOMMENDED CARE GUIDE WITH OWNER'S MANUAL PACKAGE.**

## WINDSHIELD CARE

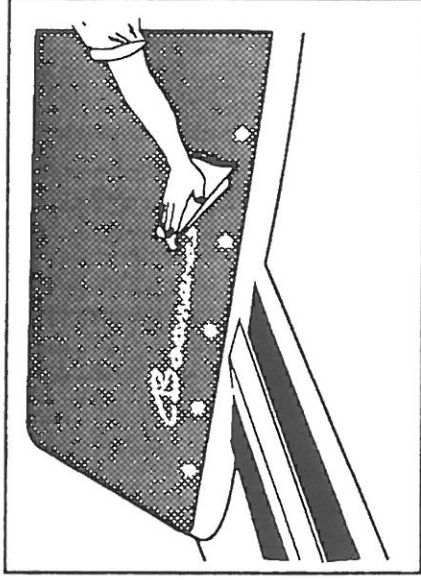

The windshield surface should be cleaned on a regular basis to insure that visibility is not obstructed.

Use a commercial glass cleaner to remove any spray spotting or stubborn stains that develop on the windshield.

Never use abrasive cleaners on glass surfaces as they may cause scratches.

## FOREIGN MATERIAL DEPOSITS

Tree sap, bird droppings, chemicals in the air or water, and other foreign matter may damage boat surfaces if not removed promptly.

Prompt washings may not completely remove all of these deposits, requiring additional cleaning. Please be certain that chemical cleaners are safe and appropriate for use on a particular surface before applying.

## BOAT HULL PROTECTION

If your Moomba is to remain in salt water for an extended period of time, the hull should be painted with a protective marine bottom paint.

Hull protection may also be advisable in fresh water where algae or plants are abundant.

## DRYING UPHOLSTERY

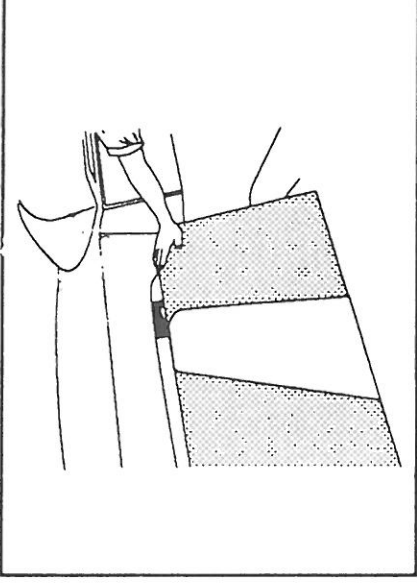

It is extremely important that all upholstery and storage compartments are thoroughly dried after each boating session. Open all storage compartments and slide all removable cushions out approximately 1" to allow air to circulate behind and underneath them.



# TECHNICAL IDENTIFICATION NUMBER

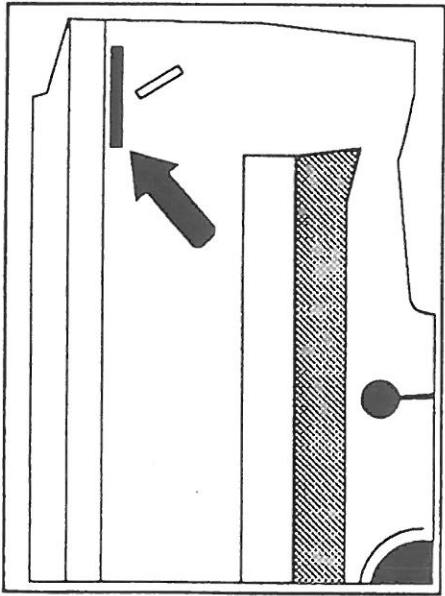

The hull identification number ( H.I.N.) is located on the upper starboard (right hand) side of the transom below the rub rail.

There is also a concealed H.I.N. located under the starboard side panel behind the driver's bucket seat. (NOT SHOWN)

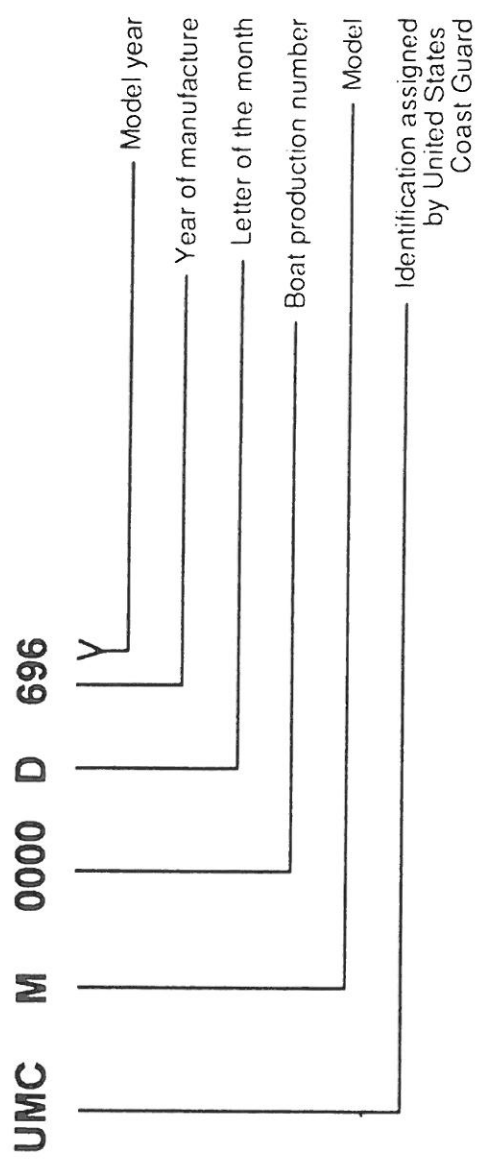

# ENGINE DATA

ENGINE DISP.	5.7 L 350 cu. in.	5.8 L 351 cu. in.	5.7 L 350 cu. in.	5.7 L 350 cu. in.	5.7 L 350 cu. in.	5.7 L 350 cu. in.	5.7 L 350 cu. in.	5.7 L 350 cu. in.	5.8 L 351 cu. in.	5.7 L 350 cu. in.	5.7 L 350 cu. in.	5.7 L 350 cu. in.	5.8 L 351 cu. in.
MODEL	PCM pro ski	PCM	Indmar	Mercury mag	Mercury EFI mag	Mercury bl. scorp.	PCM GT 40						
Horsepower @ 4400 rpm	260	260	265	265	290	315	310						
MAXIMUM RPMs Intermittent Service Continuous Service	4400 3600	4400 3600	4500 3600	4400 3600	4400 3600	5200 3600	5100 3600						
IDLE SPEED IN GEAR (rpm)	600	600	650	650	650	650	600						
Spark Plug Gap	0.035	0.035	0.045	0.045	0.045	0.045	0.035						
SPARK PLUG TYPE	AC MR43T Champion RBL8	Autolite BTF 3M Champion F 10.18 MM	AC MR43T	AC MR43LTS Champion BPR6E88	AC MR43LTS Champion BPR6E88	AC MR43LTS Champion BPR6E88	AC MR43T Champion RBL8						
OIL CAPACITY	5 qt. + filter	4 qt. + filter	4 qt. + Filter	5.5 qt. + filter	5.5 qt. + filter	5.5 qt. + filter	5 qt. + filter						
OIL FILTER	Fram PH 53 (or see engine manual)												

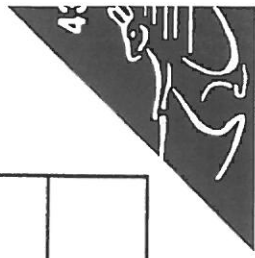



## LUBRICATION CHART

TEMPERATURE	API CLASSIFICATION AND VISCOSITY	OIL AND FILTER CHANGE INTERVAL
(0-32) <sup>°</sup> F (-18-0) <sup>°</sup> C	SAE 20 W "SE", "SF"	25 hours of operation or 30 days
(32-90) <sup>°</sup> F (0-32) <sup>°</sup> C	SAE 10 W 30 "SE", "SF"	50 hours of operation or 60 days
90 <sup>°</sup> F (32 <sup>°</sup> C) and above	SAE 10 W 40 "SE", "SF"	50 hours of operation or 60 days

## BATTERY SPECIFICATIONS

12 Volt marine type with tapered post connectors.			
ENGINE SIZE	Cold Crank @ 0 <sup>°</sup> F (-18 <sup>°</sup> C)	AMPS for Load Test	25 AMP Rate (min) Reserve Capacity
302 & 351	350 Amps (minimum)	170	80

**WARNING:** Hydrogen and oxygen gases are produced during normal battery operation or charging. Sparks or flames can cause this mixture to ignite and explode if it comes near the vent openings. Sulfuric acid in battery can cause serious burns, if spilled on skin or in eyes. Flush with clear water immediately.



# ELECTRICAL WIRING DIAGRAM

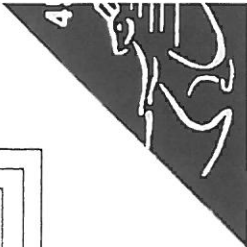
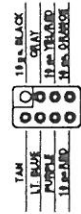
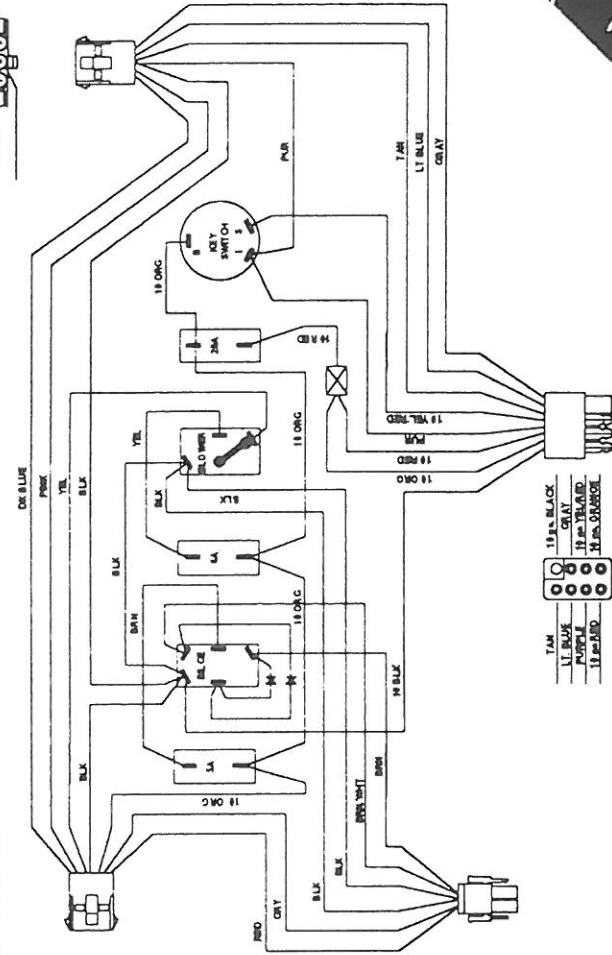
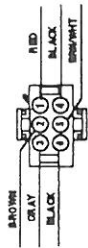
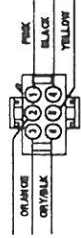
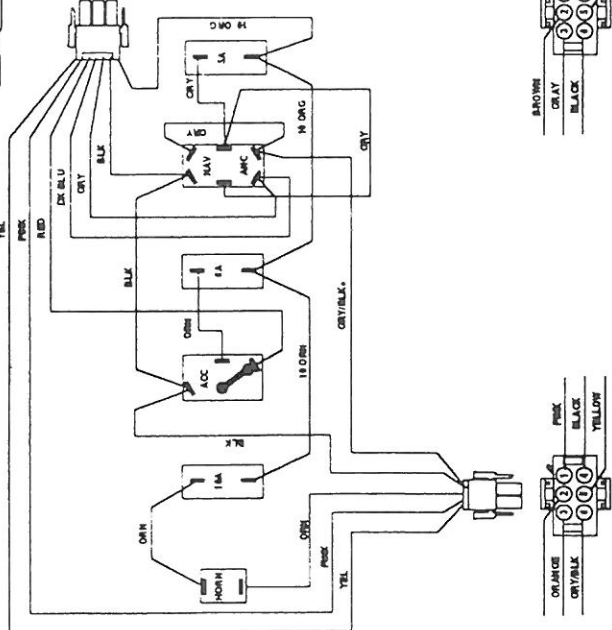
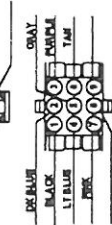
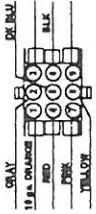
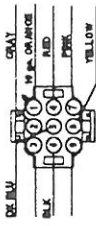
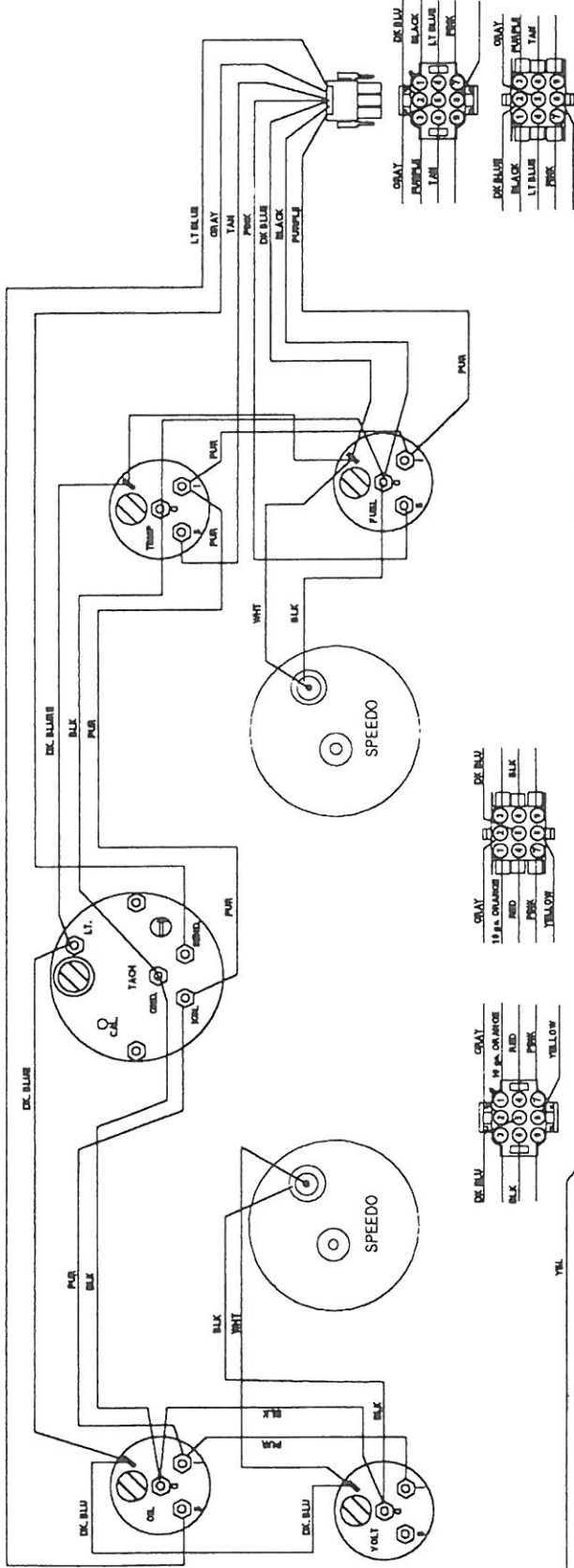

## OWNER'S RESPONSIBILITIES

- A. Before operating the boat, it is necessary to read and fully understand this owner's manual and any other information delivered with the boat.
- B. It is the owner's responsibility to take the boat to an authorized Moomba dealer to obtain warranty service.
- C. It is also the owner's responsibility to properly operate and maintain the boat in accordance with this manual and other information delivered with the boat.
- D. Maintenance records must also be kept in order to show that required maintenance has been performed on the boat.

## Additional Information

- SOME STATES DO NOT ALLOW LIMITATIONS ON HOW LONG AN IMPLIED WARRANTY WILL LAST OR THE EXCLUSION OR LIMITATION OF INCIDENTAL OR CONSEQUENTIAL DAMAGES, SO THE EXCLUSIONS AND LIMITATIONS MAY NOT APPLY TO YOU.
- THIS WARRANTY GIVES SPECIFIC LEGAL RIGHTS TO THE OWNER AND OTHER RIGHTS THAT MAY VARY FROM STATE TO STATE.
- NO ONE IS AUTHORIZED TO CREATE ANY OBLIGATION OR LIABILITY IN CONNECTION WITH MOOMBA BOATS OTHER THAN THAT WHICH IS STATED IN THE WARRANTY STATEMENT.

## PARTS UNDER WARRANTY

Along with Moomba's warranty policy, many of the components which make up a Moomba boat are also under individual warranty. These products all have specific warranty periods and conditions the owner should thoroughly understand. To help in obtaining any information or assistance, a list of product manufacturers has been compiled along with the items under warranty and their vendors. It is recommended that all warranty information be read and understood before contacting the vendor.

**NOTICE:** It is important to understand the conditions and terms of the warranty before contacting the vendor. Any questions about a specific part should be answered by contacting the vendor.

## WARRANTY PARTS

ITEM	VENDOR	WARRANTY PERIOD	TELEPHONE
BATTERY	Taylor Battery	2 year	(800) 477-3352
ENGINE	PCM Mercury Indmar	See Engine Manual See Engine Manual See Engine Manual	(803) 345-0001 (405) 377-1200 (901) 353-9930
PROP	Johnson Prop	1 year	(916) 663-9013
STEREO	Leading Edge	1 year	(800) 950-1121
BILGE PUMP	Johnson-Mayfair	1 1/2 year	(847) 671-7867
HORN	ITC	Lifetime-limited	(616) 396-1355
GAUGES	Teleflex	2 years	(941) 355-7721
SPEEDO. & PICK-UPS	Airguide	1 year	(708) 215-7888
STEERING SYSTEM	Teleflex	2 years	(941) 355-7721
STEERING WHEEL	Dino	1 year	(954) 772-8355
CONTROL CABLES	Teleflex	2 year	(941) 355-7721
TRAILER	SMP	1 year	(423) 337-3466

Please note that vendors change from time to time. Your Moomba Dealer can provide you with the latest information regarding a vendor.

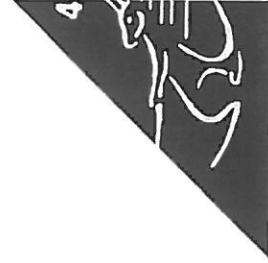

## CUSTOMER ASSISTANCE

The staff at United Marine Corporation of Tennessee is concerned with your complete satisfaction. This includes the prompt resolution of any problems that may arise during the warranty period. Normally, problems encountered may be efficiently and effectively handled by the Moomba Dealer. However, if a problem cannot be handled by the Dealer or if a solution is not satisfactory to you as the owner, please follow these steps to get the matter resolved:

### STEP ONE

Identify the problem to a member of the dealership management staff. It is most likely that the problem will be resolved at this level.

### STEP TWO

If the dealer has not solved the problem to your satisfaction, please have the problem and action documented by the dealer, then contact the factory Customer Service Representative at United Marine Corporation:

**United Marine Corporation of Tennessee**  
**5620 Highway 411 S.**  
**Maryville, TN 37801**  
**Tel. (423) 856-3035**

Describe in detail, along with appropriate documentation, the original problem encountered and the reasons why service to date was unsatisfactory. If further action is required to resolve the problem, the Customer Service Representative will dictate the appropriate action.

### STEP THREE

Finally, if after following these steps and providing documentation and after obtaining all necessary authorization, the problem is still not resolved to your satisfaction, the president of United Marine Corporation of Tennessee will personally review the problem and dictate the appropriate action.



# INDEX

Accessory Power Switch/Breaker.....	21	Electrical Wiring Diagram.....	45
Battery Box.....	4	Fiberglass Care.....	39
Battery and Cable Installation.....	38	Fire Extinguisher.....	9
Battery Specifications.....	44	Foreign Material Deposits.....	41
Beverage Holder.....	9	Fuel Filling the Fuel Tank.....	8
Bilge Area Inspection Plate.....	5	Fuel Filter.....	35
Bilge Pump Switch/Breaker.....	19	Gauge.....	18
Blower Switch/Breaker.....	20	Information.....	8
Bow Eye.....	7	Precautions.....	8
Bow Light.....	6	Tank.....	8
Break-in Period.....	23	Vent.....	9
Breaker Switches		Gauges Engine Hours.....	14
Accessory Power.....	21	Fuel.....	18
Bilge Pump.....	19	Oil Pressure.....	17
Blower.....	20	Temperature.....	18
Ignition.....	19	Voltmeter.....	20
Canvas Cover.....	32	Hoisting.....	24
Coast Guard Regulations.....	31	Horn.....	22
Cooling Systems.....	36	Hull Protection.....	41
Customer Assistance.....	48	Hull Identification Number.....	42
Drain Plug.....	28	Identification Number.....	42
Dry Storage.....	30	Ignition.....	17
Engine Data.....	43	Instrument Panel & Controls.....	13/14
Engine Hour Gauge.....	14		

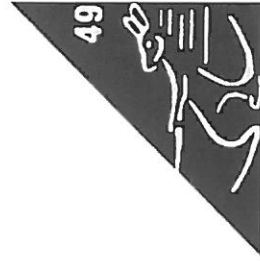

Keys, Ignition.....	17	Service & Maintenance.....	33
Lights, Nav./Anc.....	21	Shaft Log Packing Nut.....	36
Lifting Eyes.....	24	Shifter Lockout.....	16
Lubrication		Slalom Course Speeds.....	14
Body.....	36	Ski Platform.....	11
Chart.....	44	Ski Pylon (Bar).....	5
Maintenance Chart.....	34	Speedometer.....	14
Maximum Capacities.....	31	Speedometer Pickups.....	11
Mirror.....	4	Starting and Operating.....	24
Motor Box.....	4	Stern Light Pole.....	6
Oil		Tachometer.....	14
Dipstick.....	17	Temperature Gauge.....	18
Filter.....	35	Throttle Lever.....	16
Level Check.....	37	Trailer.....	25
Pressure Gauge.....	17	Boat Hook-up.....	27
Specifications.....	44	Loading Procedure.....	27
Owner's Responsibilities.....	46	Trailer Alignment.....	28
Pole Light.....	6	Unloading Procedure.....	26
Propeller.....	12	Transmission Fluid Check.....	37
Propeller Precaution.....	12	Upholstery Cleaning.....	40
Rub Rail.....	10	Drying.....	41
Safety Procedures & Equipment.....	31	Voltmeter.....	20
Seats		Wake Plate.....	10
Adjustment.....	3	Warranty Information.....	47
Driver.....	3		







# MOOMBA OWNER INFORMATION

COMPLETE INFORMATION CARD  
FOR YOUR PERMANENT RECORDS.

PURCHASE DATE			
MONTH		DAY	
YEAR			

IDENTIFICATION NUMBER

--	--	--	--	--	--	--	--	--	--

HULL

--	--	--	--	--

TRANSMISSION

--	--	--	--	--

TRAILER

--	--	--	--	--	--	--	--	--	--

ENGINE

DEALER I.D. NUM.

OWNER'S NAME

--	--	--	--	--	--	--	--	--	--	--	--	--	--	--	--	--	--	--	--

LAST NAME

FIRST NAME

ADDRESS

--	--	--	--	--	--	--	--	--	--	--	--	--	--	--	--	--	--	--	--

NUMBER

STREET

--	--	--	--	--	--	--	--	--	--	--	--	--	--	--	--	--	--	--	--

CITY

STATE

--	--	--	--	--

ZIP CODE

--	--	--	--	--	--	--	--	--	--	--	--	--	--	--	--	--	--	--	--

OWNER TELEPHONE NUMBER

---



---



---

PLACE  
STAMP  
HERE

United Marine Corporation of  
Tennessee  
5820 Highway 411 S.  
Maryville, TN 37801

**IMPORTANT!  
WARRANTY NOTICE!**

Warranty is Void if Registration Card is not completed and returned to United Marine Corp. of Tennessee 5820 Highway 411 South Maryville, TN. 37801 within 15 days of the purchase date.

**It is the Dealer's responsibility to complete and return!**



**MOOMBA WARRANTY REGISTRATION**

COMPLETE AND RETURN WITHIN 15 DAYS OF PURCHASE DATE

PURCHASE DATE: MONTH DAY YEAR

DATE: MONTH DAY YEAR

IDENTIFICATION NUMBER: \_\_\_\_\_

HULL: \_\_\_\_\_ ENGINE: \_\_\_\_\_

TRANSMISSION: \_\_\_\_\_ TRAILER: \_\_\_\_\_ DEALER I.D. NUM.: \_\_\_\_\_

OWNER'S NAME: \_\_\_\_\_

LAST NAME: \_\_\_\_\_ FIRST NAME: \_\_\_\_\_

ADDRESS: \_\_\_\_\_

NUMBER: \_\_\_\_\_ STREET: \_\_\_\_\_

CITY: \_\_\_\_\_ STATE: \_\_\_\_\_

ZIP CODE: \_\_\_\_\_

OWNER TELEPHONE NUMBER: \_\_\_\_\_