

MOOMBA



2018 Owner's Manual





WARNING

Operating, servicing and maintaining a recreational marine vessel can expose you to chemicals including engine exhaust, carbon monoxide, phthalates, and lead, which are known to the State of California to cause cancer and birth defects or other reproductive harm. To minimize exposure, avoid breathing exhaust, service your vessel in a well-ventilated area and wear gloves or wash your hands frequently when servicing this vessel. For more information go to **www.P65warnings.ca.gov/marine**.

HELIX



MONDO



CRAZ



MAX



MOJO



2018 OWNER'S MANUAL

MOOMBA[®] BOATS

Boat Information

Hull Identification Number: _____

Date of Purchase: _____

Dealership: _____

Dealer's Phone Number: _____

Engine Serial Number: _____

Trailer Serial Number: _____



1717 Henry G. Lane Street
Maryville, Tennessee 37801
Telephone: 865-983-9924 Fax: 865-983-9950
Web: www.moomba.com

Trademarks & Patents

Moomba® is a U.S. and Canadian registered trademark owned by Skier's Choice, Inc. and AutoWake® is a U. S. registered trademark owned by Skier's Choice, Inc. Skier's Choice™, the Skier's Choice logo, the Moomba logo, Mondo™, Mojo™, Craz™, Helix™ and SmartPlate™ are trademarks owned by Skier's Choice, Inc. All other trademarks are the property of their respective owners.

AutoWake® patented technology is covered by U.S. Patent Nos. 8,798,825; 9,689,395 and other patents pending. See www.skierschoice.com/patents-trademarks/

Skier's Choice, Inc. reserves the right to change product specifications at any time without incurring obligation.

© 2017 Skier's Choice, Inc. All rights reserved.

TABLE OF CONTENTS

Section 1	Introduction.....	3
Section 2	Boating Safety	10
Section 3	Emergency Procedures.....	24
Section 4	Boating Rules.....	30
Section 5	Boat Specifications	35
Section 6	Operating Information.....	40
Section 7	Starting & Operation.....	45
Section 8	Instrument Panel & Controls.....	49
Section 9	Equipment & Options.....	58
Section 10	Service & Maintenance	68
Section 11	Cleaning, Care & Storage.....	80
Section 12	Winterization & Dry Storage	83
Section 13	Technical Information	87
Section 14	Trailer Your Boat	89
Section 15	Moomba Limited Warranty	95

INTRODUCTION

Moomba inboard watersports boats are manufactured by Skier's Choice, Inc. in Maryville, Tennessee and distributed throughout the United States and the world.

This manual provides an overview for operating your Moomba boat. It should be considered a permanent part of your Moomba boat and contains important information on Safety, Boating Rules, Proper Operation and Maintenance of your boat. Should the boat be sold, this manual will provide the same important information to the next owner.

Be sure to read and understand all aspects of Boating Safety and Operation before using your boat. If you have any questions, your dealer can provide the information you need to have a safe and pleasurable boating experience.

All information, illustrations and specifications in this manual are based on the latest product information available at the time of printing. Moomba may discontinue models and equipment or change specifications and designs without any notice and without incurring obligation.

This manual contains information about several Moomba models. Some information may not apply to your boat since standards and optional equipment may vary from model to model.

As you read through this manual, you will find **CAUTION**, **WARNING** and **DANGER** symbols which require special attention. Please read them carefully! They may tell you how to avoid problems and/or endangering yourself, your passengers, and other boaters.



PLEASE REVIEW ALL SAFETY INFORMATION.

SPECIAL ATTENTION SYMBOLS



A maintenance schedule and accessory information are included to assure trouble-free operation of your boat. Should service problems arise, remember that your Moomba dealer knows your boat best and is interested in your total satisfaction.

Thank you for purchasing a Moomba boat. We hope your ownership results in an enjoyable and rewarding boating experience.

Be safe and enjoy the fun!



DAILY CHECKLIST

- Drain Plugs (Securely in place?)
- Life-Saving Devices (One for every person on board?)
- Steering System (Working smoothly and properly?)
- Fuel System (Adequate fuel? Leaks? Fumes?)
- Battery (Fully charged? Cable terminals clean and tight?)
- Engine (In neutral?)
- Capacity Plate (Are you overloaded or overpowered?)
- Weather Conditions (Is it safe to go out?)
- Electrical Equipment (Lights, horn, pump, etc.?)
- Emergency Gear (Fire extinguisher, bailer, paddle, anchor & line, signaling device, tool kit, etc.?)
- Bilge Pump (Working properly?)

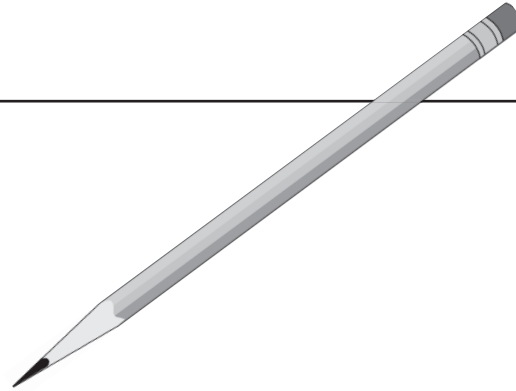

NOTE: Bilge pump should be checked prior to each use to ensure proper operation.

Check BEFORE running your boat (where applicable).

- Engine Oil Level
- Transmission Lubricant Level
- Engine Drain Plug, Transom Drain Plug and Center Drain Plug
- Leakage (Fuel, water lines and connections)

**CAUTION**

DO NOT operate engine without cooling water flowing through water pump, or pump will sustain damage and subsequent engine damage may result!

Check BEFORE running your boat.

- Oil Pressure: Refer to Engine Owner's Manual.
- Water Temperature: 160 - 180 degrees for raw water systems (water is not recirculated), and 180 - 200 degrees for closed cooling systems (water is recirculated).
- Idle RPM: (650 - 750) in gear.
- Maximum Forward RPM: Refer to Engine Owner's Manual.
- Shifting Linkage (Forward, Neutral & Reverse).

**WARNING**

GASOLINE VAPORS CAN EXPLODE. It is very important to check for fuel spillage or leaks prior to each use of your boat.

- Check engine compartment for gasoline vapors.
- Operate blower for four minutes before starting the engine.
- Always operate blower below cruising speed.

NOTE: Please refer to your Engine Owner's Manual for maximum RPM and engine break-in procedure.

IMPORTANT SAFETY INFORMATION

Your safety, as well as the safety of others with and around you, is a direct result of how you operate and maintain your boat. Read and comprehend this manual. Make sure that you understand all the controls and operating instructions before attempting to operate the boat. Improper operation is extremely dangerous.

The basic safety rules are outlined in this section of the manual. Additional precautions throughout the manual are noted by the following symbols:



This symbol indicates a potentially hazardous circumstance, which, if not avoided, may result in minor or moderate injury. It may also be used to alert against unsafe practices.



This symbol indicates a potentially hazardous situation, which, if not avoided, could result in death or serious injury.



This symbol indicates an imminently hazardous situation, which, if not avoided, will result in **death or serious injury**. This is limited to the most extreme situations.

The precautions listed in this manual and on the boat are not exhaustive. If a procedure, method, tool or part is not specifically recommended by Skier's Choice, you must satisfy yourself that it is safe for you and others, and that the boat will not be damaged or made unsafe as a result of your decision.

REMEMBER: ALWAYS USE COMMON SENSE WHEN OPERATING, SERVICING OR REPAIRING THE BOAT!

In addition to everyday safety, failure to observe safety recommendations may result in severe personal injury or death to you or to others. Use caution and common sense when operating your boat. Don't take unnecessary chances!

Be certain that all boat passengers are aware of this information and conform to boat safety principles.

SAFE BOATING

Safe boating practices may seem obvious, but people have thought up risky and dangerous activities in boats, with boats, and behind boats. Just because you or your passengers have seen a boating maneuver performed or have seen a particular activity promoted, do not assume there is no risk of injury or death. Before you or your passengers go out in the boat and engage in any water sport activity, give careful consideration to the risks. Plan ahead. Think twice before you try something new behind your boat or with your boat. Know the limits of you, your passengers and your equipment and do not exceed them.

In addition to careful review of this manual, you should be aware as well that there are many sources of information available. Skier's Choice urges you to pursue additional training, such as safety and seamanship courses offered by the U.S. Coast Guard Auxiliary and the U.S. Power Squadron.

Safe boating and safe actions may seem obvious, yet every year US Coast Guard statistics give evidence that many people disregard safe boating practices. Do not take safety for granted. Think twice. We want all our boat owners and their passengers, friends, and families to have a safe and enjoyable experience on the water.

US COAST GUARD AUXILIARY BOATING SAFETY COURSE

The purchaser of a new 2018 Moomba boat is entitled to a USCGA Boating Safety Course that Moomba will pay for. Please see the Certificate in your owner's packet or your dealer for more details.

WATER SPORTS NAMES AND TERMINOLOGY

There are many types of towed water sports, and they are known by many different names. The more popular sports are wakeboarding, waterskiing, surfing, wakeskating and tubing. And there are many others. The terms used to describe participants in towed water sports activities also vary greatly. Typical terms include rider, skier, and wakeboarder. To keep the language in this manual straightforward, we use rider or skier to refer to a participant in any towed water sport. The terms ski, skiing, riding, surfing or wakeboarding are used to refer to any towed water sport.

SAFETY TRAINING ORGANIZATIONS

The following is a listing of just some of the agencies and organizations that offer safety training or information:

American Red Cross, National HQ

2025 E Street NW, Washington, DC 20006
(202) 303-4498 www.redcross.org

USA Waterski

1251 Holy Cow Rd., Polk City, FL 33868
(863) 324-4341 www.usawaterski.org

Boat Owners Association of the United States (BOAT/US)

880 South Pickett Street, Alexandria, VA 22304
(703) 461-4666 www.boatus.com

National Safe Boating Council

P.O. Box 509, Bristow, VA 20136
(703) 361-4294 www.safeboatingcouncil.org

U.S. Coast Guard Auxiliary Public Relations Center

9449 Watson Industrial Park, St. Louis, MO 63126
(877) 875-6296 www.cgaux.org

U.S. Power Squadron

P.O. Box 30423, Raleigh, NC 27622
(888) 367-8777 www.usps.org

On-Line Basic Boating Safety Course

www.boatsafe.com

National Marine Manufacturers Association

231 S. LaSalle Street, Suite 2050, Chicago, IL. 60604
(312) 946-6200 www.nmma.org

Federal law requires certain safety equipment to be on board at all times. In addition, responsible boaters carry other equipment in case of emergency. Check with the local boating authorities for any additional requirements over and above the federal stipulations.

SAFETY EQUIPMENT

Your Moomba has been equipped at the factory with most of the federally required safety equipment for inland waters (Class 1, 16'-to-26').

This equipment includes:

- UL-approved Marine Fire Extinguisher, Type A-BC (2 lbs.), good for solids, liquids, and electrical fire
- ABYC-approved Marine Mufflers with water injection
- USCG-approved Marine Flame Arrestor
- USCG-approved Engine Box Ventilation with sparkless power blower
- ABYC-approved Electric Horn sound warning device
- USCG-approved inland lighting

Federal law also requires at least one Type I, II or III Personal Flotation Device (PFD) for each person on board or being towed on water skis or other recreational equipment. In addition, one throwable Type IV PFD must also be on board. **As the owner, obtaining the appropriate PFDs is your responsibility.** Your Moomba dealer can and will be happy to assist you.

NOTE: Requirements for coastal waters and inland waters differ. Check with the local authorities for more information.

A smart owner will avoid potential problems on an outing by having additional equipment on board. Normally, this equipment is dependent on the body of water and the length of the trip. We suggest the following—as a minimum. Your Moomba dealer can also assist you with additional recommendations:

- An anchor with at least 75 feet of line
- A manual bailing device for removing water
- A combination oar/boat hook
- A day-and-night visual distress signal
- A first aid kit and manual
- An airway breathing tube
- A waterproof flashlight
- A set of local navigation charts
- Mooring lines and fenders
- Extra engine oil
- A tool kit
- A portable AM/FM radio or weather radio
- VHF handheld marine radio
- Cell Phone

Boating-related accidents are generally caused by the operator's failure to follow basic safety rules or written precautions. Most accidents can be avoided if the operator is completely familiar with the boat, its operation, and can recognize potentially hazardous situations before an accident occurs.

GENERAL SAFETY PRECAUTIONS

Failure to adhere to these precautions may result in severe injury or death to you and/or others.

WARNING

- Improper operation is extremely dangerous. Operators must read and understand all operating manuals supplied with the boat before operation.
- Remain seated at all times while boat is in motion.
- Never stand or allow passengers to stand while the boat is moving. You or others may be thrown from the boat.
- Children in the bow of the boat should be accompanied by an adult at all times.
- Never operate the boat while under the influence of alcohol or drugs.
- On-board equipment must always conform to the governing federal, state, and local regulations.
- Gasoline vapors can explode. Before starting engine, open engine box, check engine compartment for gasoline vapors, and operate blower for at least four minutes.
- Run blower below cruising speed.
- Leaking fuel is a fire and explosion hazard. Inspect system regularly. Examine fuel tanks for leaks or corrosion at least annually.
- Never override or modify the engine safety shut-off switch or engine neutral starting safety switch in any way.
- Never remove or modify components of the fuel system in any way except for maintenance by qualified personnel. Tampering with fuel components may cause a hazardous condition.
- Never allow any type of spark or open flame on board. It may result in fire or explosion.
- It is the owner's responsibility to check tightness of the tower bolts BEFORE each use.
- The tower is designed to pull a single (1) individual. DO NOT climb or sit on the tower rope may loop on inverted tricks. DO NOT sit behind the pulling point of the Tower.
- Comply with the capacity limits stated on the capacity warning label in the boat.

DANGER

- To avoid serious personal injury, DO NOT be on or about the swim platform while engine is running and keep away from rear of boat while engine is running.
- To avoid serious personal injury, DO NOT operate engine while anyone is on or about the swim platform or in the water near the boat.

CAUTION

- The tow bar is not designed for vertical extensions. Any modifications to the tow bar or its mountings may result in damage to the boat and injury to the user.
- The tower may strike low objects. Check clearance height around docks, shore, overhanging objects, bridges and power lines.
- Do not pull past 45 degrees of the centerline of the boat. Failure to follow this rule could result in the boat capsizing.

CAUTION

- It is the driver's responsibility to ensure all passengers are seated when boat is underway.

WARNING

Failure to adhere to these warnings may result in severe injury or death to you and/or others.

- This boat is a high-performance boat and capable of quick and tight turns and changes in direction. It is the driver's responsibility to operate the boat in a manner to ensure the safety of all passengers.

WARNING

Boaters must continuously be aware of weather conditions.

- Sudden storms, wind, lightning, etc., can unexpectedly put boaters in grave danger. Always check the local weather report before going boating.

WARNING

It is the driver's responsibility to determine if weather or other factors have created an unsafe boating environment.

- The driver is solely responsible for the consequences of their actions.

WATER SPORTS SAFETY

Riders are obligated to be as aware of the fundamental safety rules as well as the boat operator. If you are new to towed water sports, seek certified training before starting. You will find it especially helpful to join a local ski club and USA Waterski when possible.

Always remember that the majority of water sports injuries are the result of impacts with other objects, so always look where you are going and be aware of what is going on around you.



Failure to adhere to these warnings may result in severe injury or death to you and/or others.

- Every skier or rider must always wear a USCG-approved personal flotation device.
- Maintain a distance of at least 100 feet from all other objects, including other boats, piers, rafts, mooring and navigational buoys, pilings, abutments, or any other items.
- Always have an experienced driver and observer in the boat when skiing.
- Never ski in shallow water, close to shore, or in water where you do not know the depth or what is beneath the surface.
- Never put your arm, head, or any other part of your body through the handle-bridle of the ski line nor wrap the line around any part of the body at any time.
- Never ski at night, or directly in front of other boats.
- Never jump from a boat that is moving at any speed, nor enter or exit the water when the engine is running (ON).
- Make sure that everyone knows and uses approved skiing hand signals and common skiing courtesy.
-

SKI PYLON EXTENSIONS

The use of a ski pylon extension or extensions in excess of 7-feet vertical is not recommended by Moomba on our products. If you elect to use merchandise such as these, be aware that they could create excessive stress on your boat and subjectively cause damages not covered by the warranty.

CARBON MONOXIDE (CO) SAFETY



Carbon monoxide is a colorless, odorless and tasteless gas. It is produced by gasoline engines and is a component of exhaust fumes.

Shut off the engine when people are on the swim platform or in the water around the rear of the boat.

Do not do any activities which put people in close proximity of the transom when the engine is running.

For the most current information on carbon monoxide, you may call, write or visit on-line any of the following:

United States Coast Guard

Office of Boating Safety (CG-5422)
2100 Second Street SW STOP 7581,
Washington, DC 20593-7581
1-800-368-5647 www.uscgboating.org

NMMA

National Marine Manufacturers Association

231 S. LaSalle St., Suite 2050, Chicago, IL 60604
312-946-6200 www.nmma.org

American Boat & Yacht Council, Inc.

613 Third St., Suite 10, Anapolis, MD 21403
410-956-4460 www.abycinc.org

PRODUCT MISUSE

Misuse of the product or use of it in a manner for which it was never intended can create dangerous situations. The driver and passengers are responsible for using the product safely and as intended. The driver must operate the boat in a manner that ensures the safety of all passengers. If you or your passengers are unsure about use of the product, about performing certain boating maneuvers or are unsure about a particular water activity, refer to this manual or contact a knowledgeable source such as your local dealer, Skier's Choice, Inc., the US Coast Guard, or your local boating authority.

CAPACITY AND WEIGHTING YOUR BOAT

Do not exceed the capacity warning label affixed to the boat in the helm area. The capacity limit is shown in the number of people and weight limit in pounds. The combined weight of people and gear must be considered when loading the boat. Ballast and fuel have been considered in the capacity limit and do not need to be added to the people and gear weight. Ballast weight above factory installed equipment must be calculated into the total weight of people and gear.

Although water intrusion and waves spilling inside a boat is an obvious boating hazard, this hazard can increase when weighting your boat for water sports such as wakeboarding or wakesurfing. Do not overweight the boat or exceed boat capacity. Use good judgment when using unbalanced weight in your boat. Concentrating weight in a rear corner of the boat for wakesurfing puts the top of the deck closer to water level. Backwash, large waves and choppy water are more likely to swamp the boat in this situation.

When loading your boat give separate attention to the bow area. Excess and unevenly distributed weight in the bow of the boat can create a water influx hazard, unstable steering conditions, and even loss of control. Driver visibility can be reduced if the bow is overloaded or unevenly weighted.

WARNING

Excess and improper loading of bow area forward of windshield may cause water influx, operating instability, and loss of control resulting in injury or death. See Seating Capacities for bow limits.

Use good judgment when weighting your boat for any towed water sports. Educate yourself on the proper responses for the differing and potentially unsafe conditions you could encounter.

MAXIMUM CAPACITIES

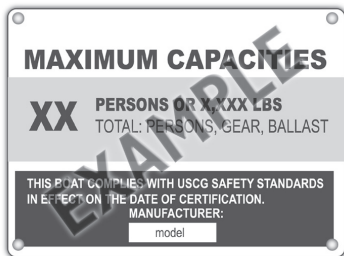

In compliance with United States Coast Guard Regulations, Moomba Boats meet or exceed all safety standards designed for recreational boats. To ensure safe handling and performance, each Moomba boat displays a maximum capacity sticker (see sample), stating the maximum passenger weight load allowable.

NOTE: Refer to the Maximum Capacity Sticker on your boat for allowable loading.

WARNING

Do not exceed the maximum capacity of the boat.

The driver must be aware of all passenger's locations and positions, and passengers must stay alert to changes in direction.

The boat is capable of quick and tight turns. Such maneuvers can cause unseated occupants to be thrown around or out of the boat. Alert passengers before changes in direction.

PROPER SEATING

Proper seating is an important element of boating safety. Proper seating consists of sitting with your buttocks in full contact with a seat cushion within easy reach of a suitable handhold or grab rail anytime the boat is underway. Handholds and grab rails should be used to secure oneself and prevent loss of balance. Do not sit in locations not designed as a seat. For instance, do not sit on seat backs, do not sit on the sides or gunwale of the boat, and do not sit on the sundeck while the boat is in motion. See examples below of proper sitting positions.



MONDO

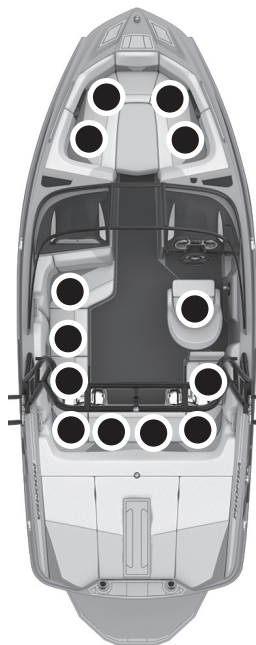

13 Passengers

CRAZ

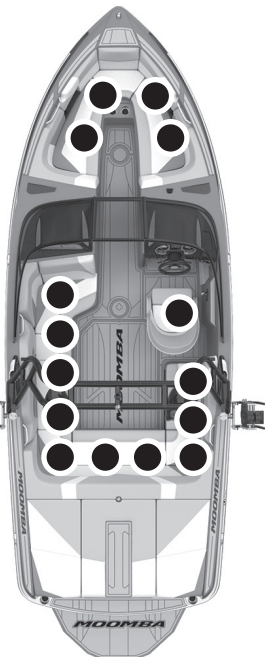

16 Passengers

HELIX

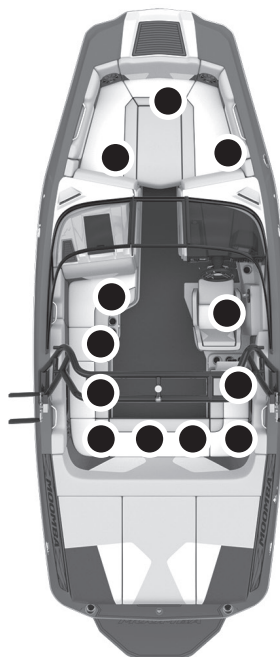

12 Passengers

MOJO/MOJO PRO

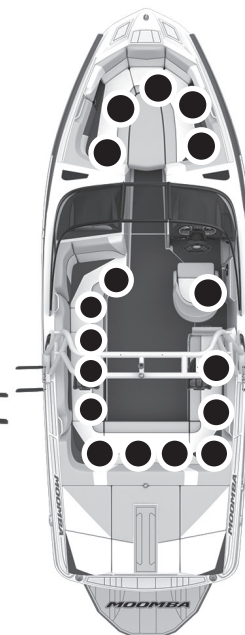

17 Passengers

MAX

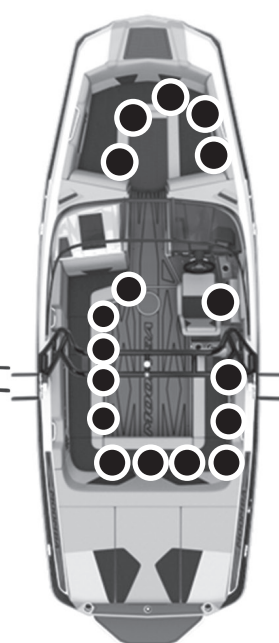

17 Passengers

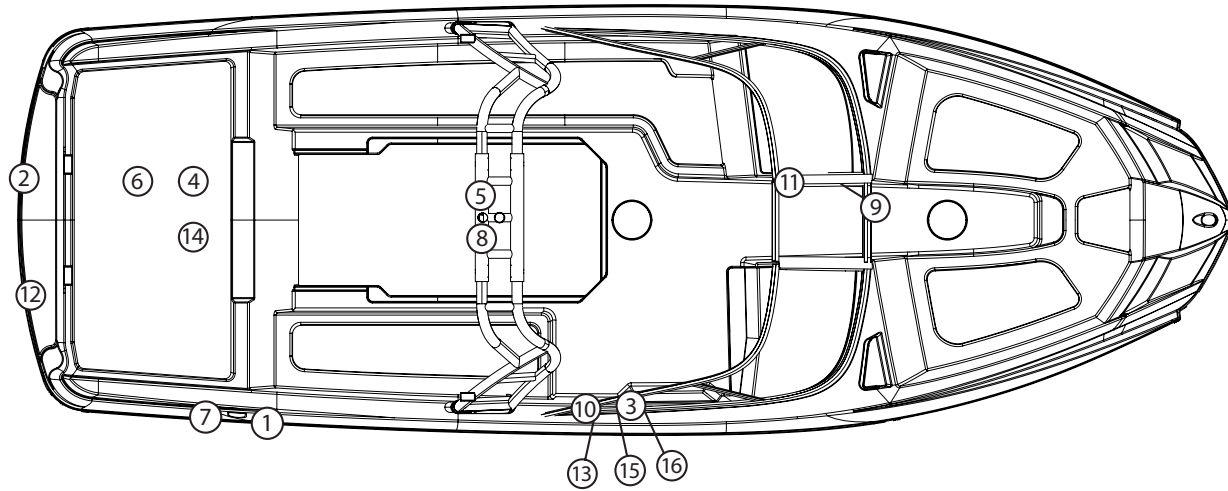

TYPICAL WARNING LABEL LOCATIONS — V-DRIVE MODELS

Warning labels are placed on your boat to alert you to potential hazards that may not be obvious. They also tell you how to avoid the hazard. Warning labels should never be removed and, if any label is damaged, it should be replaced as soon as possible.

**Labels on the following pages.*

WARNING PLATES & LABELS

Read and note ALL warning plates and labels from bow to stern that appear on the boat, including these.

If your warning decals should become damaged in any way, please contact your Moomba Dealer or write Skier's Choice, Inc. to request replacement warning decals. The decals will be provided free of charge. Your boat's serial number (located on the transom) must be included for warning decal requests.

①

⚠ WARNING

- AVOID SERIOUS INJURY OR DEATH.
- FIRE, EXPLOSION AND SPLASHING FUEL HAZARD.
- IF TANK IS OVERFILLED, FUEL WILL DISCHARGE OUT THIS PORT.



②

⚠ WARNING

- AVOID SERIOUS INJURY OR DEATH.
- TOW EYE SHOULD BE USED ONLY FOR TOWABLE WATER SPORTS DEVICES WITH 1 OR 2 INDIVIDUALS. TOW EYE WEIGHT LIMIT IS 800 LBS.
- DO NOT USE TOW EYE FOR OTHER TOWABLE OBJECTS OR TOWING BOATS.
- DO NOT USE TOW EYE TO LIFT BOAT.

③

THIS BOAT COMPLIES WITH U.S. COAST GUARD SAFETY STANDARDS IN EFFECT ON THE DATE OF CERTIFICATION WITH THE EXCEPTION OF CERTAIN FUEL SYSTEM REQUIREMENTS ASSOCIATED WITH IT'S FUEL INJECTED ENGINE AS AUTHORIZED BY U.S. COAST GUARD GRANT OF EXEMPTION (CGB 09-003). MAINTENANCE OF THE FUEL SYSTEM IN THIS BOAT SHOULD BE PERFORMED ONLY BY EXPERIENCED TECHNICIANS USING IDENTICAL FUEL SYSTEM COMPONENTS.

SKIER'S CHOICE, INC. 1717 HENRY G. LANE ST., MARYVILLE, TN 37801

(inside motorbox)

④

⚠ WARNING

- AVOID SERIOUS INJURY OR DEATH.
- LEAKING FUEL IS A FIRE AND EXPLOSION HAZARD.
- INSPECT SYSTEM REGULARLY. EXAMINE FUEL SYSTEM FOR LEAKS AND CORROSION AT LEAST ANNUALLY.



⑤

⚠ WARNING

DO NOT TRAILER BOAT WITH ANY WAKEBOARDS, WATERSKIS, OR ANY OTHER RECREATIONAL TOWABLES IN THE BOARD RACKS. FAILURE TO FOLLOW THESE GUIDELINES CAN RESULT IN LOSS, DAMAGE, INJURY OR DEATH.

⑥

⚠ WARNING

Failure to follow these warnings could cause **SERIOUS INJURY** or **DEATH**

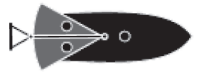
- Only use this tow pylon for waterskiing, boarding, or recreational towables.
- Do not use this tow pylon for parasailing, kite flying, pyramids, group pulls, barefoot/teaching booms, pylon extensions or towing other boats.
- Do not sit in the path of the tow line when it is in use.

⑦

⚠ WARNING

The use of E-15 fuel in this vessel is prohibited by law.
See Owners Manual for complete explanation.

8

⚠ WARNING

- Failure to follow these warnings while using the tower could cause serious injury or death.
- Lock the tower in place and secure all hardware before and during use.
- Do not tow more than 1 persons or 500 pounds at one time from this tower.
- Only use this tower for waterskiing, boarding, or recreational towables.
- Do not use this tower for parasailing, kite flying, pyramids, group pulls, towing other boats, or tubes.
- Do not climb on, sit on, stand on, jump off of or dive off of the tower.

11

BOATMAN'S CHECK LIST

For your safety and enjoyment, check all of these items before you start the engine.

- ✓ WEATHER CONDITIONS - Safe to go out?
- ✓ CAPACITY PLATE - Are you properly loaded?
- ✓ PERSONAL FLOTATION DEVICES - Adequate types and number on board?
- ✓ EMERGENCY GEAR - Fire extinguisher, anchor with line, tool kit, signaling device, bailer, paddle, etc., on board?
- ✓ BATTERY - Fully charged? Cable terminals clean and tight?
- ✓ STEERING SYSTEM - Working smoothly and properly?
- ✓ FUEL SYSTEM - Adequate fuel? Any leaks or fumes?
- ✓ ENGINE - In neutral?
- ✓ ELECTRICAL EQUIPMENT - Lights, horn, pump working properly?
- ✓ BILGE PUMP - Working properly and free of debris?
- ✓ DRAIN PLUG - Securely in place?

9

⚠ WARNING





Failure to follow these warnings could cause serious injury or death

 <p>REMAIN PROPERLY SEATED AND HOLD ON TO AVAILABLE HANDRAILS while boat is moving to avoid falling overboard or being ejected from the boat. Do not sit on the gunwales or deck edges.</p> <p>USCG APPROVED LIFE JACKETS should be on board for all passengers and on all towed participants.</p>	<p>DO NOT EXCEED THE BOW CAPACITY of 5 persons or 700 pounds. Overloading the bow of the boat can cause loss of control, swamping and/or capsizing.</p> <p>DO NOT OBSTRUCT OPERATOR VISIBILITY. Operators must have a clear view in front of them to avoid collisions.</p>
---	--

10



⚠ WARNING

Failure to follow these warnings could cause **SERIOUS INJURY** or **DEATH**

<p>GASOLINE VAPORS CAN EXPLODE. BEFORE STARTING ENGINE:</p> <ul style="list-style-type: none"> - OPERATE BLOWER for 4 minutes. - CHECK THE ENGINE COMPARTMENT for gasoline vapors by sight and smell.  <p>OPERATE BLOWER to clear gasoline vapors from engine compartment when engine is at idle, while below cruising speed and after stopping engines.</p> <p>CARBON MONOXIDE (CO) CAN CAUSE BRAIN DAMAGE OR DEATH.</p> <ul style="list-style-type: none"> - Engine and generator exhaust contains odorless and colorless carbon monoxide gas. - Signs of carbon monoxide poisoning include nausea, headache, dizziness, drowsiness, and lack of consciousness. - MOVE TO FRESH AIR if anyone shows signs of carbon monoxide poisoning. - SEE OWNER'S MANUAL for additional information regarding carbon monoxide poisoning. 	<p>CHECK WEATHER FORECAST BEFORE DEPARTING DOCK and heed all weather advisories.</p> <p>WEAR SAFETY LANYARD at all times while operating boat to prevent unmanned boat operation.</p>  <p>NEVER OPERATE WHILE UNDER THE INFLUENCE OF DRUGS OR ALCOHOL.</p> <p>DO NOT OVERLOAD THE BOAT. ENSURE THAT WEIGHT IS PROPERLY AND EVENLY DISTRIBUTED fore and aft and on both sides of the boat to avoid poor handling, sudden loss of control, swamping and/or capsizing.</p> <p>PASSENGERS SHOULD WEAR U.S. COAST GUARD APPROVED LIFE JACKETS.</p>  <p>MAKE SURE THAT ALL PASSENGERS ARE PROPERLY SEATED WHILE UNDERWAY. To avoid passengers falling overboard or being ejected from the boat, do not allow passengers to sit on seat backs, gunwales or outermost deck edges while boat is moving.</p>	<p>REDUCE SPEED BEFORE ATTEMPTING SUDDEN OR SHARP TURNS, AND MAINTAIN SAFE SPEEDS for water conditions and environment at all times. Maneuverability at high speeds is limited, and sudden turns may cause loss of boat control.</p> <p>KEEP PROPER LOOKOUT AND SAFE DISTANCE for the conditions at all times to avoid collisions.</p>  <p>OBEY APPLICABLE NAVIGATION RULES AND BOATING LAWS.</p> <p>USE CAUTION AND PROPER LIGHTING during nighttime boating and boating in adverse weather.</p> <p>READ THE OWNER'S MANUAL, AND COMPLETE THE BOATER'S PRE-OPERATION CHECKLIST prior to boat operation.</p> <p>THE DRIVER IS RESPONSIBLE for operating boat in manner that ensures safety of passengers.</p>
--	--	--

12

⚠ DANGER

	<p>CONTACT WITH A SPINNING PROPELLER WILL CAUSE SERIOUS INJURY OR DEATH.</p> <p>STAY CLEAR OF BOAT AND STAY OFF SWIM PLATFORM WHILE ENGINE IS RUNNING.</p>
	<p>CARBON MONOXIDE (CO) CAN CAUSE BRAIN DAMAGE OR DEATH.</p> <ul style="list-style-type: none"> • Engine and generator exhaust contains odorless and colorless carbon monoxide gas. • Carbon monoxide will be around the back of the boat when engines or generators are running. <p>MOVE TO FRESH AIR, if you feel nausea, headache, dizziness, or drowsiness.</p>

13

⚠ DANGER

- CONTACT WITH A SPINNING PROPELLER WILL CAUSE SERIOUS INJURY OR DEATH.
- SHUT OFF ENGINES while people are in the water near the boat, on the swim platform, or on the boarding ladder.
- NEVER OPERATE IN REVERSE TOWARD A PERSON in the water.





14

SERVICE OF THE ENGINE INSTALLED IN THIS BOAT REQUIRES SPECIAL TOOLS, TRAINING AND GENUINE REPLACEMENT PARTS WHICH ARE ONLY AVAILABLE FROM SKIER'S CHOICE, INC. THE FUEL SYSTEM SHOULD BE SERVICED ONLY BY A SKIER'S CHOICE TRAINED CERTIFIED TECHNICIAN. DO NOT ATTEMPT TO SERVICE THE SYSTEM YOURSELF.

15

⚠ WARNING

Failure to follow these warnings could cause serious injury or death

Remain properly seated and hold on to available handrails while boat is moving to avoid falling overboard or being ejected from the boat. Do not sit on gunwales or deck edges.

Do not overload the boat. Occupants and gear must be evenly distributed on both sides of the boat to avoid poor handling, sudden loss of control, swamping and/or capsizing.

Refer to your specific model's Designated Occupant Positions depicted in the Owner's Manual.

Keep limbs and body clear of all tow lines at all times to avoid entanglement and other types of injuries.

USCG approved life jackets should be on board for all passengers and all towed participants.

16

MAXIMUM CAPACITIES

14 PERSONS OR 2200 LBS.
2200 LBS. PERSONS CLEAR

MANUFACTURER: SKIER'S CHOICE, INC.
SUPRA SR MARYVILLE, TN

Section 3 Emergency Procedures

Reprinted from "Fishing and Skiing Boats Owner's Manual" with permission from the NMMA.

The time to think about emergencies is before they happen. Plan ahead. Know what to do before you encounter any of these situations. Wear a PFD (Personal Flotation Device) when boating.

WARNING

EXPLOSION/FIRE/ASPHYXIATION HAZARD

- Open flame cooking appliances consume oxygen. This can cause asphyxiation or death.
- Maintain open ventilation.
- Liquid fuel may ignite, causing severe burns.
- Use fuel appropriate for type of stove.
- Turn off stove burner before filling.
- Do not use stove for comfort heating.

FIRE/ASPHYXIATION HAZARD

Use special care with flames or high temperatures near urethane foam, if used in construction of your boat. Burning, welding, lights, cigarettes, space heaters and the like can ignite urethane foam. Once ignited, it burns rapidly, producing extreme heat, releasing hazardous gases and consuming much oxygen.

EXPLOSION

- If explosion is imminent, put on PFDs, grab distress signals and survival gear, and immediately abandon ship.

FIRE

- Turn off engines, generators, stoves and blowers.
- Extinguish smoking materials.
- Fixed fire suppression system, if equipped, has heat sensors that automatically flood machinery space with a fire extinguishant. Allow extinguishant to "soak" compartment for at least 15 minutes to cool hot metals or fuel before cautiously inspecting fire area. Have portable fire extinguishers ready. Do not breathe fumes or vapors caused by the fire or extinguishant.
- If no fixed firefighting system is installed and fire is in engine compartment, discharge portable fire extinguishers through transmission cover which is typically under the rear seat. Do not open engine hatch as this feeds oxygen to the fire.
- If you have access to fire, direct contents of extinguishers at base of flames, not at the top.
- Throw burning materials overboard if possible.
- Move anyone not needed for firefighting operations away from the flames.
- Signal for help.
- Put on PFDs (Personal Flotation Devices), grab distress signals and survival gear, and prepare to abandon ship.

ABANDONING SHIP

WARNING

BURN HAZARD

- Swim against the current or wind if you abandon ship. Leaking fuel will float with the current and may ignite.
- When clear of danger, account for all who were on board, and help those in need.
- Use distress signal.
- Keep everyone together to make rescue easier.

FLOODING, SWAMPING OR CAPSIZING

- **STAY WITH THE BOAT!** A boat will usually float even if there is major hull damage. Rescuers can spot a boat much easier than a head bobbing in the water.
- Signal for help.

COLLISION

- Account for everyone on board.
- Check for injuries.
- Inspect structural damage.
- Reduce flooding.
- Signal for help.
- **STAY WITH THE BOAT!**

GROUNDING

Action depends on how hard the boat hits bottom and whether the boat remains stranded. If it is a simple touch, you may need only to inspect the hull. If you are aground, assess the situation before reacting. In some cases, throwing the boat into reverse can cause more damage.

Basic Guidelines

- Inspect damage to hull, propulsion and steering systems.
- Check for leaks. If water is coming in, stopping the flow takes priority over getting free.
- Determine water depth all around the boat and type of bottom (sand, mud, rocks, etc.). This will help you decide which way to move the boat.
- Determine if tide, wind or current will drive the boat harder aground or will help free it.

LEAKS

- Immediately switch on bilge pumps.
- Assign crew to operate manual pumps, if needed.
- If boat is taking on water, have someone take the helm while you manage damage control.
- Slow or stop to minimize inflow. However, if you can keep a hole above water by maintaining speed, do so.
- If possible, patch the outside with whatever material is available.

TOWING

WARNING

PERSONAL INJURY HAZARD

Towing or being towed stresses the boats, hardware and lines. Failure of any part can seriously injure people or damage the boat.

A recreational boat towing another is usually a last resort because of possible damage to one or both boats. The Coast Guard or a private salvage company is better equipped. A recreational boat may assist by standing by, and possibly keeping the disabled boat's bow at a proper angle until help arrives. Only when conditions are ideal—that is, waters are calm, disabled boat is small, and one or both skippers know correct technique—should a recreational boat tow another.

Towing Vessel

- Be sure your boat will not run aground too.
- Because you are maneuverable and the grounded boat is not, you should pass the towline to the grounded boat.
- Use double-braided or braid-on-braid line. Never use three strand twisted nylon; it has too much elasticity and can snap back dangerously.
- Fasten the towline as far forward as possible on the upwind or up-current side of the towing boat. Fastening it to the stern will restrict maneuverability of the towing boat.
- If possible, use a bridle.
- Move slowly to prevent sudden strain on slack line.
- Be ready to cast loose or cut the line if the towing situation becomes hazardous.

Vessel Being Towed

- Attach the towline to the bow eye.
- If the boat has eyebolts in the transom for pulling skiers, a towline may be attached to a small bridle hooked to both eyebolts.
- If it is necessary to be towed after being freed, keep someone at the wheel to steer.

Both Vessels

- If you attach the towline to a fitting, be sure the fitting is fastened with a through bolt and is reinforced on the underside.
- Creating a bridle with a line around the hull or superstructure will distribute the load over a wide area; pad pressure points. This technique can be used on both the towing and towed boat.
- Keep lines clear of propellers on both boats.
- Keep hands and feet clear of the other boat.
- Never hold a towline after it is pulled taut.

PERSON OVERBOARD

- Immediately sound an alarm and keep pointing to the person overboard.
- Throw a life preserver even if the person is wearing a PFD. It will serve as a marker.
- Immediately stop or slow the boat, then circle toward the victim.
- Keep person overboard on helm side so operator has the person constantly in sight.
- Approach from downwind and move alongside into the wind for pickup.

- When almost alongside, stop the engine in gear to prevent dangerous propeller “windmilling.”
- As part of your emergency plan, consider what to do if you were alone and fell overboard (e.g., wear PFD, keep signal device in PFD, attach emergency stop switch lanyard to yourself).

DROWNING

- Swim to rescue a drowning victim only as a last resort.
- Immediate resuscitation is critical! At least two people on board should be certified in CPR.
- Keep the victim warm.
- Use care in handling. Spinal injury may exist if the victim fell overboard.
- Signal for help.

MEDICAL EMERGENCY

- In an emergency, you may be far from professional medical assistance. Be prepared. Take a first aid course, and carry a first aid kit. Be aware of special conditions that may affect anyone on board.

CARBON MONOXIDE

Carbon monoxide is an odorless, colorless, extremely toxic gas. Symptoms of carbon monoxide poisoning are dizziness, ears ringing, headaches, nausea and unconsciousness. A poisoning victim's skin often turns cherry red.

Have the victim breathe fresh air deeply. If breathing stops, resuscitate. A victim often revives, then relapses because organs are damaged by lack of oxygen. Seek immediate medical attention.

PROPULSION, CONTROL OR STEERING FAILURE

- Shut off engine.
- Put out an anchor to prevent drifting.
- Determine if you can fix the problem yourself. See engine operator's manual if engine is flooded.
- Signal for help.

RADIO COMMUNICATION

Radio is the boat operator's main method of receiving safety information and summoning aid. VHF-FM radio is the primary means of short-range communication. Single sideband radio (SSB) is used for longer range communication.

VHF-FM Channel 16 and SSB 2182 kHz are designated for emergency use. Such situations can be categorized as:

- **Emergency** - "MAYDAY, MAYDAY, MAYDAY" - Used when a life or vessel is in imminent danger.
- **Urgency** - "PAN-PAN, PAN-PAN, PAN-PAN" (pronounced PAHN-PAHN) - Used when a person or vessel is in some jeopardy less than indicated by a Mayday call.
- **Safety** - "SECURITY, SECURITY, SECURITY" (pronounced SAY-CURE-IT-TAY) - Used for navigational safety or weather warning.

An emergency situation will be hectic and there will not be time to learn proper radio procedure. LEARN WHAT TO DO BEFORE YOU NEED TO DO IT.

If you hear a distress call, stop all radio transmissions. If you can directly assist, respond on the emergency frequency. If you cannot assist, do not transmit on that frequency. However, continue to monitor until it is obvious that help is being provided.

Consult your national boating law enforcement agency.

VISUAL DISTRESS SIGNALS

U.S. Coast Guard regulations require boats in coastal waters and the Great Lakes to carry visual distress signals for day or night use, as appropriate for the time of operation. Exempt from the day signals requirement, but not night signals, are boats less than 4.8 meters (16 feet), open sailboats less than 7.9 meters (26 feet), boats participating in organized events, and manually propelled boats.

- If you are required to have visual distress signals, at least three safety-approved pyrotechnic devices in serviceable condition must be readily accessible. They must be marked with a date showing the service life, which must not be expired.
- Carry three signals for day use and three signals for night use. Some pyrotechnic signals, such as red flares, meet both day and night use requirements.
- Store pyrotechnic signals in a cool, dry location. An orange or red watertight container prominently marked "Distress Signals" is recommended.

Other recognized visual distress signals include:

- Flames in a bucket
- Code flags November and Charlie
- Square flag and ball
- Black square and ball on orange background flag
- Orange flag (certified)
- Electric distress light (certified) - for night use only.
- Dye marker (any color)
- Person waving arms
- U.S. ensign flown upside down

Audible Distress Signals

U.S. Coast Guard regulations require one hand, mouth or power-operated whistle or horn, audible for at least a half mile.

Other recognized audible distress signals include:

- Radio communication (see Emergency Procedures - Radio Procedures - Radio Communication)
- Radiotelegraph alarm
- Position indicating radio beacon
- Morse Code SOS (3 short, 3 long, 3 short) sounded by any means
- Fog horn sounded continuously

BASIC BOATING RULES

You should be aware of these rules and follow them whenever you encounter another vessel on the water.

The rules presented in this manual are condensed and have been provided as a convenience only. Consult your local U.S. Coast Guard Auxiliary (USCGA) or Department of Motor Vehicles (DMV) for a complete set of rules governing the waters in which you will be using your boat. If you plan to travel—even for a short trip—you would be well served to contact the regional USCGA or DMV in the area where you will be boating.

Review and understand all local and state laws.

Any time two vessels on the water meet one another, one vessel has the right-of-way. It is called the *stand-on* vessel. The vessel which does NOT have the right-of-way is called the *give-way* or *burdened* vessel.

These rules determine which vessel has the right-of-way, and accordingly, what each vessel should do.

The vessel with the right-of-way has the duty to continue its course and speed, except to avoid an immediate collision. When you maintain your direction and speed, the other vessel will be able to determine how best to avoid you.

The vessel which does not have the right-of-way has the duty to take positive and timely action to stay out of the way of the *stand-on* vessel. Normally, the *give-way* vessel should not cross in front of the *stand-on* vessel. Slow down or change directions briefly and pass behind the other vessel. You should always move in such a way that the *stand-on* operator can see what you are doing.

This rule is called Rule 2 in the International Rules and says, *“In obeying and construing these rules due regard shall be had to all dangers of navigation and collision, and to any special circumstances, which may render a departure from the above rules necessary in order to avoid immediate danger.”*

ENCOUNTERING OTHER VESSELS

There are three main situations in which you may encounter other vessels and you must observe the Steering Rules in order to avoid a collision. These are:

- **Meeting** (you are approaching another vessel head-on)
- **Crossing** (you are traveling across the other vessel's path)
- **Overtaking** (you are passing or being passed by another vessel)

Using the following illustration in which you are the boat in the center, you should give right-of-way to all vessels shown in the white area. In this instance, you are the give-way vessel. All vessels in the shaded area must yield to you as you are the stand-on vessel. Both you and the meeting vessel must alter course to avoid each other.

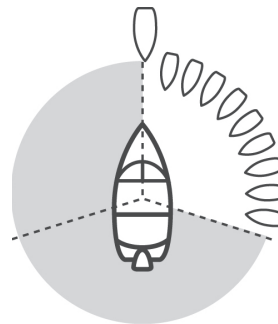

If you are meeting another power vessel head-on, and you are close enough to run the risk of collision, neither of you has the right-of-way. Both of you should alter course to avoid an accident. You should keep the other vessel on your port (left) side. This rule doesn't apply if both of you can clear each other by continuing your set course and speed.

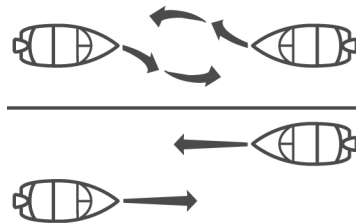

When two power-driven vessels are crossing each other's path close enough to run the risk of collision, the vessel that views the crossing vessel to the starboard (right) side must give-way.

If the other vessel is to the port (left) side, maintain your course and direction, provided the other vessel gives you the right-of-way as it should.

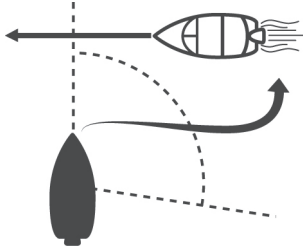

If you are passing another vessel, you are the give-way vessel. This means that the other vessel is expected to maintain its course and speed. You must stay out of its way as you clear it, altering course and speed as necessary.

Conversely, if you are being passed by another vessel, you should maintain your speed and direction so that the other vessel can steer itself around you.

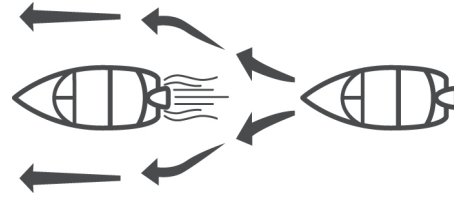

There are three other rules to always remember when driving your boat around other vessels.

When navigating in narrow channels, you should keep to the right when it is safe and practical to do so. If the operator of a power-driven vessel is preparing to go around a bend that may obstruct the view of other water vessels, the operator should sound a prolonged blast on the whistle or horn—four to six seconds.

If another vessel is around the bend, it too should sound the whistle or horn. Even if no reply is heard, however, the vessel should still proceed around the bend with caution.

If you navigate these type of waters, you should carry a portable air horn, which are available from local marine supply stores.

All vessels which are fishing with nets, lines or trawls are considered under International Rules to be fishing vessels. Boats with trolling lines are not considered fishing vessels.

Fishing vessels have the right-of-way, regardless of position. These vessels, however, cannot impede the passage of other vessels in narrow channels.

Sailing vessels should normally be given the right-of-way. The exceptions to this are:

- When the sailing vessel is overtaking the power-drive vessel, the power-driven vessel has the right-of-way.
- Sailing vessels should keep clear of any fishing vessel.
- In a narrow channel, a sailing vessel should not hamper the safe passage of a power-driven vessel which can navigate only in such a channel.

The waters of the United States are marked for safe navigation by the lateral system of buoyage. The markers and buoys you will encounter have an arrangement of shapes, colors, numbers and lights to show which side of the buoy a boater should pass when navigating in a particular direction.

The markings on these buoys are oriented from the perspective of being entered from seaward while the boater is going towards the port. This means that red buoys are passed on the starboard (right) side when proceeding from open water into port, and black buoys are to port (left) side. When navigating out of port, your position to the buoys should be reversed: red buoys to port and black buoys to starboard.

Many boating bodies of water are entirely within the boundaries of a single state. The Uniform State Waterway Marking Systems has been devised for these waters. This system uses buoys and signs with distinctive shapes and colors to show regulatory or advisory information.

These markers are white with black letters and orange borders. The information signifies speed zones, restricted areas, danger areas and general information.

Remember: Markings may vary by geographic location. Always consult local boating authorities before driving your boat in unfamiliar waters.

(See examples of buoys and markers next page.)

BUOYS & MARKERS

<p>Proceeding forward head of navigation from seaward</p>	<p>MAIN CHANNEL BUOYS</p> <p>① 1, 3, 5</p> <p>White Light Green Light</p> <p>old OR new</p> <p>LIGHTED BUOY (Port Hand)</p> <p>Odd number, increasing toward head of navigation. Leave to port (left) proceeding upstream.</p>
<p>SECONDARY CHANNEL BUOYS STARTS NEW NUMBERING SYSTEM</p> <p>② c1</p> <p>White Light Red Light</p> <p>old OR new</p> <p>LIGHTED BUOY (Starboard Hand)</p> <p>Even number, increasing toward head of navigation. Leave to starboard (right) proceeding upstream.</p>	<p>SECONDARY CHANNEL BUOYS STARTS NEW NUMBERING SYSTEM</p> <p>③ A</p> <p>White Light Top Mark Red Light</p> <p>old OR new</p> <p>LIGHTED SAFE WATER BUOY</p> <p>No number. Marks mid-channel. Pass on either side. Letter has no lateral significance; it is used for identification and location purposes.</p>
<p>④ n2</p> <p>White Light Red or White Light Red Light</p> <p>old OR new</p> <p>LIGHTED PREFERRED CHANNEL TO PORT BUOY</p> <p>No number. Topmost band red; preferred channel is to the left of the buoy. Letter has no lateral significance; it is used for identification and location purposes.</p>	<p>SECONDARY CHANNEL BUOYS STARTS NEW NUMBERING SYSTEM</p> <p>⑤ n2</p> <p>White Light Red or White Light Red Light</p> <p>old OR new</p> <p>LIGHTED PREFERRED CHANNEL TO PORT BUOY</p> <p>No number. Topmost band red; preferred channel is to the left of the buoy. Letter has no lateral significance; it is used for identification and location purposes.</p>

Section 5 Boat Specifications

HELIX



HELIX SPECIFICATIONS:

Overall Length w/o Platform.....	20'5"6.25M
Overall Length w/Platform.....	22'5"6.85M
Overall Length w/Platform & Trailer	24'2"7.37M
Width (Beam)	102"2.59M
Overall Width w/Trailer	102"2.59M
Draft	26"0.67M
Weight - Boat Only	4,000 lbs.....	1,814K
Weight - Boat & Trailer	4,900 lbs.....	2,222K
Height-On Trailer W/Tower Up.....		120"
Height-On Trailer W/Tower Down.....		90"
Capacity - Passenger	12.....	12
Capacity	2,000 lbs.....	907K
Capacity - Fuel	39 gals.....	147L
Capacity - Ballast (Standard).....	1,700 lbs.....	771K
Capacity - Ballast (Optional)	2,100 lbs.....	952k
Engine	400.....	6.2L

NOTE: Add weight for Fuel, Batteries, Options & Gear to determine true boat weight.

MONDO

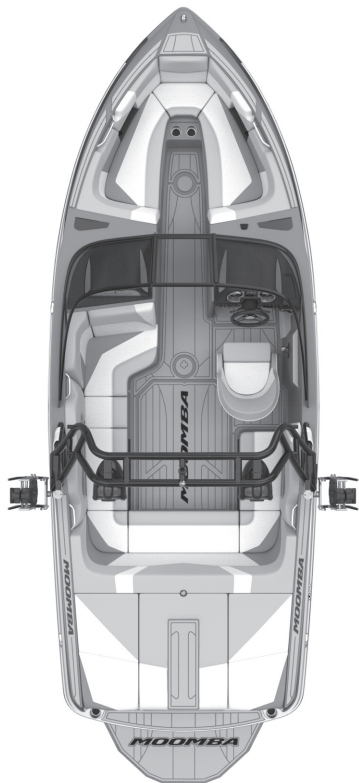

MONDO SPECIFICATIONS:

Overall Length w/o Platform	20' 6"	6.25M
Overall Length w/Platform.....	22' 6"	6.86M
Overall Length w/Platform & Trailer	24' 3"	7.40M
Width (Beam)	99"	2.51M
Overall Width w/Trailer.....	102"	2.59M
Draft	25"	.64M
Weight - Boat Only.....	3,900 lbs.....	1,769K
Weight - Boat & Trailer	4,800 lbs.....	2,177K
Height-On Trailer W/Tower Up.....		118"
Height-On Trailer W/Tower Down.....		89"
Capacity - Passenger	13.....	13
Capacity	2,000 lbs.....	907K
Capacity - Fuel	39 gals.....	147L
Capacity - Ballast (Standard).....	1,800 lbs.....	589K
Capacity - Ballast (Optional FRT).....	2,300 lbs.....	227K
Engine.....	400.....	6.2L

NOTE: Add weight for Fuel, Batteries, Options & Gear to determine true boat weight.

CRAZ

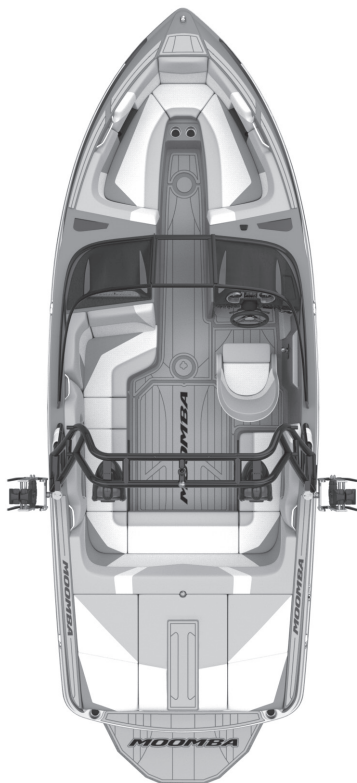

CRAZ SPECIFICATIONS:

Overall Length w/o Platform.....	22'	6.55M
Overall Length w/Platform.....	24'	7.16M
Overall Length w/Platform & Trailer	26' 2"	7.70M
Width (Beam)	100"	2.46M
Overall Width w/Trailer.....	102"	2.59M
Draft	27.5"64M
Weight - Boat Only.....	4,200 lbs.....	1,905K
Weight - Boat & Trailer	5,400 lbs.....	2,450K
Height-On Trailer W/Tower Up.....	123"	
Height-On Trailer W/Tower Down.....	94"	
Capacity - Passenger	16.....	16
Capacity	2,400 lbs.....	816K
Capacity - Fuel	49 gals.....	147L
Capacity - Ballast (Standard).....	3,000 lbs.....	136K
Engine.....	400.....	6.2L

NOTE: Add weight for Fuel, Batteries, Options & Gear to determine true boat weight.

MAX

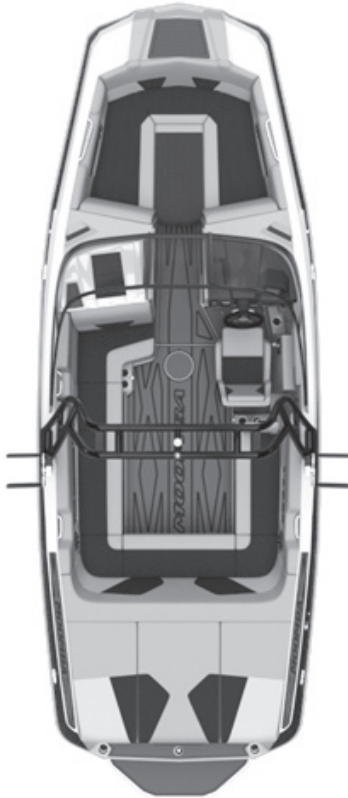

MAX SPECIFICATIONS:

Overall Length w/o Platform	22' 6"6.88M
Overall Length w/Platform.....	24' 6"7.49M
Overall Length w/Platform & Trailer	26' 8"8.16M
Width (Beam)	102"2.59M
Overall Width w/Trailer.....	102"2.59M
Draft	27.5"0.70M
Weight - Boat Only.....	4,500 lbs.....	2,041K
Weight - Boat & Trailer	5,700 lbs.....	2,585K
Height-On Trailer W/Tower Up.....	128"	
Height-On Trailer W/Tower Down.....	98"	
Capacity - Passenger	17	17
Capacity	2,800 lbs.....	1,270K
Capacity - Fuel	65 gals.....	246L
Capacity - Ballast (Standard).....	3,000 lbs.....	136 K
Engine.....	400.....	6.2L

NOTE: Add weight for Fuel, Batteries, Options & Gear to determine true boat weight.

Mojo

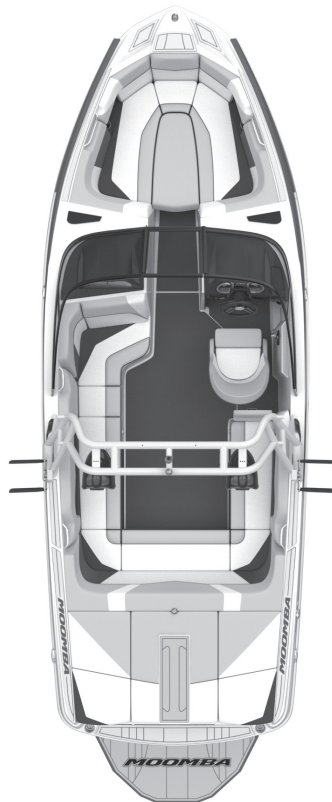

MOJO SPECIFICATIONS:

Overall Length w/o Platform.....	23'	7.01M
Overall Length w/Platform.....	25'	7.62M
Overall Length w/Platform & Trailer	27' 2"	8.28M
Width (Beam)	100"	2.54M
Overall Width w/Trailer.....	102"	2.59M
Draft	27.5"	0.70M
Weight - Boat Only	4,400 lbs.....	1,996K
Weight - Boat & Trailer	5,600 lbs.....	2,540K
Height-On Trailer W/Tower Up.....	123"	
Height-On Trailer W/Tower Down.....	94"	
Capacity - Passenger	17	17
Capacity	2,500 lbs.....	1,133K
Capacity - Fuel	49 gals.....	185L
Capacity - Ballast (Standard).....	3,000 lbs.....	136K
Engine.....	400.....	6.2L

NOTE: Add weight for Fuel, Batteries, Options & Gear to determine true boat weight.

Section 6

Engine Break-In and Fuel Information

BREAK IN

Taking care to properly break in your new engine will pay off in the long run. In our years of field testing, we have proven that an Indmar engine, when properly broken in according to our simple procedures, will last longer, run better and have fewer repairs over its lifetime.

Your new engine does not require an elaborate break-in procedure. Just follow these simple instructions and you are off to a great start.

The three (3) most important aspects of new engine break-in are:

- Avoid running engine at high speeds.
- Do not carry a heavy load (passengers, gear, etc.).
- Vary your boat speed during break-in. Do not run at the same RPM for a long period of time.

COAST GUARD REGULATIONS

The United States Coast Guard boating regulations prescribe minimum standards of safety to be met and maintained by all watercraft. It is necessary that your boat remain in compliance with these regulations.

The staff at Skier's Choice, Inc. recommend that all boat operators complete a Coast Guard approved boating safety course.

During the BREAK-IN process, engine temperature should be carefully monitored and speed should be reduced if overheating is evident. **ALSO, PLEASE REFER TO ENGINE OWNER'S MANUAL FOR BREAK-IN INFORMATION.**

NOTICE: PLEASE REFER TO ENGINE OWNER'S MANUAL for maximum RPM and engine break-in procedure.

CAUTION

Do not exceed maximum RPM recommended for your engine. Exceeding the maximum RPM may result in damage to the engine.

DANGER

Before starting your engine you must open the engine box and check engine compartment and bilge for gasoline and oil vapors.

FUEL PRECAUTIONS



Indmar 6.2L Engines

Use a gasoline with a minimum octane rating of 89. See engine owner's manual for more information.

WARNING

DO NOT use gasoline containing methyl alcohol (methanol). Methanol can damage your boat's fuel system.

CAUTION

E-10 fuels require fuel stabilizers that are specifically designed for E-10 fuels to help prevent moisture absorption, phase separation and gasoline stabilization.

CAUTION

Gasoline stabilizer should be added to the fuel tank when the boat is used infrequently or whenever your boat will not be used for two weeks or more. During storage always add gasoline stabilizer to reduce gumming or tank sludge.

FUELING



WARNING

SPARKS WHILE FUELING COULD CAUSE AN EXPLOSION!

BEFORE FUELING:

1. Turn off engine.
2. Turn off ignition.
3. Extinguish cigarettes or any open flame.



WHILE FUELING:

- Keep hose nozzle in contact with fill pipe to provide a ground against static sparks.
- Fill tank at a slow rate to avoid any spillage.

E15 FUEL

DO NOT USE E15 FUELS! E15 fuel WILL damage your engine and it will not operate.

- THIS DAMAGE IS NOT COVERED BY ANY WARRANTY

FUEL CAP



The fuel cap is located on the rear deck, 2-4 feet from the stern. To open, push black tab located on the bottom side of the gas cap. When the black tab is pushed, the gas cap will hinge upward.

To close, push the gas cap down. When the gas cap is completely closed a “click” sound should be heard. The audible “click” ensures that the gas cap is closed and sealed.

The new fueling system prevents spillage from occurring. Air is allowed to escape from the front and rear of the gas tank. Both vents are on a central fuel line, which run to a central holding

container for the vapor. The vapor is released over time. This type of venting system allows for the tank to be filled without building any back pressure. Without back pressure, spillage should be completely eliminated from the fueling process.

This venting system doesn't allow water to enter the fuel system. In the unlikely event that water runs up against the fuel vent, the fuel vent has a one-way valve. The one way valve allows for air to release, but denies water from entering. The gas cap itself is sealed with a rubber seal. When the gas cap is “clicked” closed the seal prevents any water from entering the system.

FILLING THE TANK

CAUTION

Be especially careful when filling the fuel tank. DO NOT overfill the tank. Overfilling can damage the system's carbon filters and render the emissions control useless.

If fuel is spilled on stripes or decals, apply a common bath cleaner (nonabrasive) and wipe with a damp cloth. Rinse the spill area with clean water.

FUEL TANK PUMP



Your boat contains a fuel system that is designed using current fuel delivery technology. The common terminology for this type of system is: Pump in Tank.

The system consists of a dual high pressure pump canister that is mounted inside the fuel tank. On the top of the canister there is a fuel pressure regulator. The engine's fuel lines are connected to the in tank fuel pump via a specially designed shielded, flexible high pressure fuel hose. This hose is pressurized. This system requires special tools and knowledge to service and maintain and as such is not owner serviceable.

The fuel filter for the boat's fuel delivery system is in the fuel tank. This style filter system is considered a lifetime filter under normal circumstances.

The pump in tank fuel delivery system uses the fuel to lubricate and cool the fuel pumps. Running the pumps with very low fuel levels or running the pumps without fuel in the tank can induce air into the pumps which may shorten the fuel pump's longevity. This type of fuel pump damage is not warrantable.

FUELING CONDITIONS

The following conditions may be considered normal operation of the fuel gauge and fuel system:

- Gas station pumps may shut off before the fuel gauge indicates **FULL**.
- The amount of fuel required for fill-up may not exactly correspond to the gauge.
- The gauge needle may not move away from **FULL** until some time after fill-up.
- The gauge needle may move during turns, stops, and acceleration.

NOTE: Become familiar with engine hourly fuel consumption at various speeds and know when to check the fuel gauge.



THE FOLLOWING USCG INFORMATION IS IMPORTANT TO YOUR SAFETY AND SAFE OPERATION OF THE BOAT:

“THIS BOAT COMPLIES WITH U.S. COAST GUARD SAFETY STANDARDS IN EFFECT ON THE DATE OF CERTIFICATION WITH THE EXCEPTION OF CERTAIN FUEL SYSTEM REQUIREMENTS ASSOCIATED WITH ITS FUEL INJECTED ENGINE AS AUTHORIZED BY U.S. COAST GUARD GRANT OF EXEMPTION (CGB 09-003). MAINTENANCE OF THE FUEL SYSTEM IN THIS BOAT SHOULD BE PERFORMED ONLY BY EXPERIENCED TECHNICIANS USING IDENTICAL FUEL SYSTEM COMPONENTS.”

“SERVICE OF THE ENGINE INSTALLED IN THIS BOAT REQUIRES SPECIAL TOOLS, TRAINING AND GENUINE REPLACEMENT PARTS WHICH ARE ONLY AVAILABLE FROM SKIER’S CHOICE, INC. THE FUEL SYSTEM SHOULD BE SERVICED ONLY BY A SKIER’S CHOICE TRAINED CERTIFIED TECHNICIAN. DO NOT ATTEMPT TO SERVICE THE SYSTEM YOURSELF.”

A standard pre-starting procedure should be always be followed before the first start-up of the day.

1. Check the engine oil level.
2. Check for gasoline fumes in bilge or engine compartment.
3. Operate engine blower for four minutes before starting the engine to remove any fumes.
4. Check automatic and manual operation of bilge pump. Make sure bilge areas are empty.

Other items might also be inspected, depending on the boat and its use. It is advisable to formulate a check list particular to the equipment and operation of your boat.

REFER TO THE BOATMAN'S CHECKLIST OF THIS MANUAL. LOCATED IN THE GLOVEBOX OF YOUR BOAT.

Consult the local Coast Guard Auxiliary or Power Squadron for full details on boating safety.

NOTE: Add-on electrical accessories should never be connected to the ignition terminal or ignition circuit.

IMPORTANT: DO NOT continue to operate the starter for more than 15 seconds at a time without pausing to allow the starter motor to cool down for at least two minutes. This will also allow the battery to recover between starting attempts. PLEASE REFER TO ENGINE OWNER'S MANUAL FOR ADDITIONAL DETAILS.

 **DANGER**

Do not start engine if gas fumes are present!

 **DANGER**

BEFORE STARTING ENGINE, BE SURE THAT THE SHIFT SELECTOR IS IN NEUTRAL.

Please refer to the engine manual before starting.

CENTER DRAIN PLUG -V-DRIVE MODELS

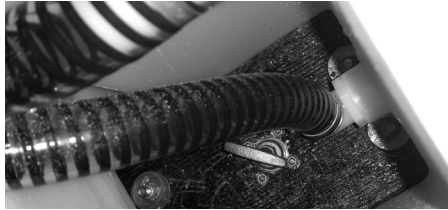
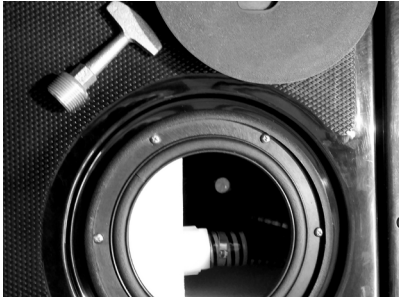

The center drain plug is accessed via the access cover in the center floor panel.

It is extremely important that the drain plug is always checked before starting the engine. The drain plug should be secured in place using a wrench.

WARNING

DO NOT start engine until center drain plug is checked and secured in place.

REAR DRAIN PLUG

The rear drain plug is located at the back of the boat, near the bottom of the transom. It is extremely important that the drain plug is always checked before starting the engine. The drain plug should be secured in place using a wrench.

WARNING

DO NOT start the engine until the drain plug is checked and secured in place. **DO NOT** try to install the drain plug while the engine is running!

STARTING YOUR ENGINE

- Place shift selector in Neutral with the throttle in the upright (zero) position. (If throttle is not in the idle position, the throttle position sensor will not allow the engine computer to proceed with a normal starting procedure).
- Turn Ignition Key to Start Position to operate the starter.
- Release the key when engine starts (key will return to run position).
- Allow the engine to establish a good idle (30 to 60 seconds) before getting underway.
- Shift slowly into forward or reverse, allowing the transmission time to engage before powering up.

NOTE: It is normal for the idle to speed up in cold start conditions.

CAUTION

DO NOT continue to operate the starter for more than 15 seconds at a time without pausing to allow the starter motor to cool down for at least two minutes. This will also allow the battery to recover between starting attempts. **PLEASE REFER TO ENGINE OWNER'S MANUAL FOR ADDITIONAL DETAILS.**

NOTE: Should the EFI engine become "flooded" use the following procedure to start:

- Place shift selector in Neutral and disengage the transmission by pushing the transmission lockout button located at the bottom of the lever.
- With the transmission disengaged, push the lever forward to full throttle position. (This will cause the computer to shut off the fuel injectors, which will allow the engine to clear of excess fuel during starting).
- Turn the Ignition Key to Start Position and operate the starter for no more than 15 seconds at a time, until the engine starts.
- When the engine starts, back off the throttle and allow the engine to establish a good idle (30 to 60 seconds).
- Return the throttle to idle position and the transmission lockout will automatically reengage the transmission in neutral position.
- When ready to get underway, shift slowly into forward or reverse, allowing the transmission time to engage the gearing before powering up.

WARM-UP

Always let engine warm up to normal operating temperature before accelerating.

THROTTLE LEVER

The throttle lever controls both the throttle and the transmission. The idle position (normally vertical) is the zero throttle position and the neutral position for the transmission. A safety ring (umbrella) keeps the lever from being accidentally moved to engage the transmission.

To place the transmission into gear, with your hand placed over the lever ball, pull up on the safety ring (umbrella) and slowly push the lever into forward gear or slowly pull the lever back into reverse gear.

CAUTION

Never shift the lever directly from the neutral (vertical) position into a speed position.

- To prevent damage to the transmission, always allow the transmission time to engage before accelerating the engine.
- Once the transmission is engaged, you may accelerate as quickly as you like.

TRANSMISSION LOCKOUT BUTTON

The Transmission Lockout button allows the transmission to be disengaged while giving the throttle full operating range. With the lever in the idle position (normally vertical), push the button located at the bottom of the lever to disengage the transmission. The throttle may then be operated in any open position (forward of neutral or back of neutral upright position). Return the throttle to idle position, and the transmission lockout will automatically reengage the transmission in neutral position.

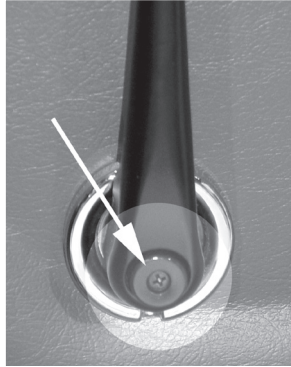

MIRRORS



The rear view mirror is installed as a standard item. The mirror is adjustable so that it may be set for each driver.

- Mirror should always be checked before driving.
- Mirror angle will change with each new driver.

Section 8 Instrument Panel & Controls

Warning Stickers

Always heed the dash mounted warning stickers.



GASOLINE VAPORS CAN EXPLODE!

BEFORE STARTING ENGINE:

- Check engine compartment for gasoline or vapors.
- Operate blower for four minutes before starting engine.
- Run blower below cruising speed.
- Turn off engine before using ski platform.

FUEL GAUGE

The fuel gauge is located on the tachometer. This gauge indicates the approximate quantity of fuel remaining in the tank when the ignition switch is in the "ON" position.

NOTE: DO NOT run the tank to empty. To prevent condensation from forming in the tank, it is recommended that the tank be filled when the gauge indicates 1/4 tank of fuel remaining.

SPEEDOMETER



The speedometer indicates the water speed of the boat in miles per hour.

NOTE: If the speedometer registers erratically, check speedometer pickup.

SPEEDOMETER PICKUP

The speedometer pickup is located on the bottom of the hull. The pickup measures the speed of water passing the paddlewheel. Poor water conditions or foreign material may clog the pickup causing the speedometer to register incorrectly.

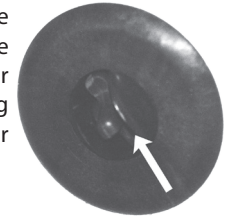

Inspect the paddlewheel and remove any foreign material only when engine is off.

Please see paddlewheel owner manual in the Boat Owner's Packet for more information.

Tachometer



The tachometer registers the operating speed of the motor's shaft output and may be used as an alternative to speedometer if weight and water conditions permit.

DO NOT exceed the recommended RPM during break-in and normal operation of your motor. Exceeding the manufacturer's suggested RPM may cause damage to the engine.

PANEL SWITCHES *Moomba Standard Package**

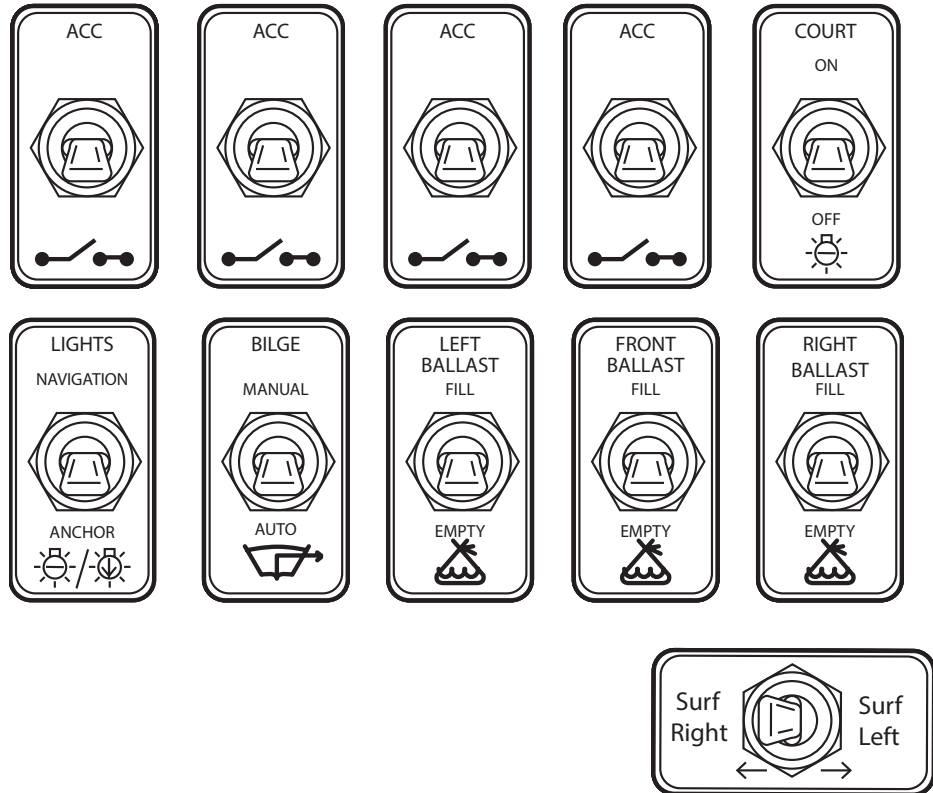

NAVIGATION LIGHTS SWITCH

The Navigation Light switch supplies power to the Bow Light, the Stern Light and the Pole Light.

Operation (Refer to Illustration Below):

When underway during night time operation, set the switch in the NAV position to activate all of the running lights.

When docked or at anchor, set the switch, in the ANC position to activate only the pole light.

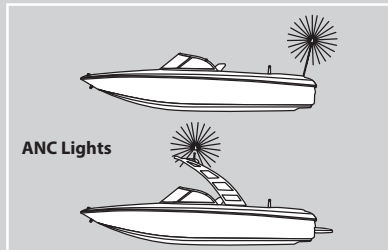
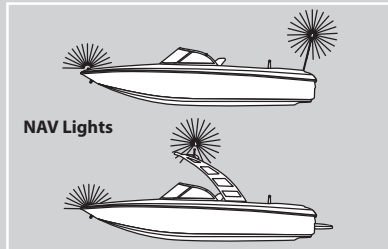

COURTESY LIGHT SWITCH

The Courtesy switch supplies power to the lighting throughout the boat.

DOCKING LIGHT SWITCH

The Docking Light switch supplies power to the docking lights. Switch must be turned on before lights will operate.

BALLAST SWITCHES

The Ballast switches supply power to the ballast pumps. Configuration may vary depending on the number of ballast bags.

ACCESSORY SWITCH (2 POSITIONS)

The Accessory switch supplies power to an extra circuit for accessories that may be added.

NOTICE

If any lights, bilge, stereo, courtesy lights, or accessories fail to operate, press the appropriate circuit breaker located under the dash.

Switch configuration may vary slightly based on options. If you have any questions regarding operation, please contact your dealer.

IGNITION SWITCH



Located on the port side of the dashboard, the ignition switch has four positions. In the vertical position, the ignition is “OFF”.

One position clockwise is the “RUN” position and this will power the switches and energize the motor.

The full clockwise position is the “START” position.

NOTE: All electrical equipment should be turned off when the boat is in storage.

WARNING

GASOLINE VAPORS CAN EXPLODE.
BEFORE STARTING ENGINE:

- CHECK ENGINE COMPARTMENT FOR GASOLINE VAPORS
- OPERATE BLOWER FOR 4 MINUTES.
- VERIFY BLOWER OPERATION.
- RUN BLOWER BELOW CRUISING SPEED.
- ENGINE SHOULD BE OFF BEFORE USING SKI PLATFORM.

SAFETY LANYARD/ENGINE SHUT-OFF SWITCH

Your Moomba is equipped with a Safety Lanyard/Engine Shut-Off switch. In order for the engine to run, the plastic tip of the safety lanyard must be attached to the switch. If the clip is removed from the switch, the engine will not run.

Note: Extra lanyard in glovebox.



WARNING

Avoid serious injury or death. Attach Safety Lanyard to driver prior to operating the boat.

IGNITION KEYS

Two ignition keys are provided with the boat. Key entry into the ignition may sometimes be difficult due to the rubber boot protector. Please do not unduly force the key into the ignition. Key tumblers are located vertically, so the key should be vertical when placed into the switch.

NOTE: Ignition key blanks may be purchased through your Moomba dealer.

CHECK ENGINE LIGHT



Your boat has an amber check engine light. It functions much the same as the check engine light in your car. If the engine control module senses certain engine parameters out of range a trouble code is set, and the light will come on.

If the light does come on, stop using the boat and contact an authorized Indmar or Skier's Choice Service Center.

TILT STEERING



Tilt steering may be adjusted up or down in five different locking positions. To adjust, depress the tilt lever located beneath the bezel and move the steering wheel to the desired position. Release the lever to lock the wheel into place.

HORN

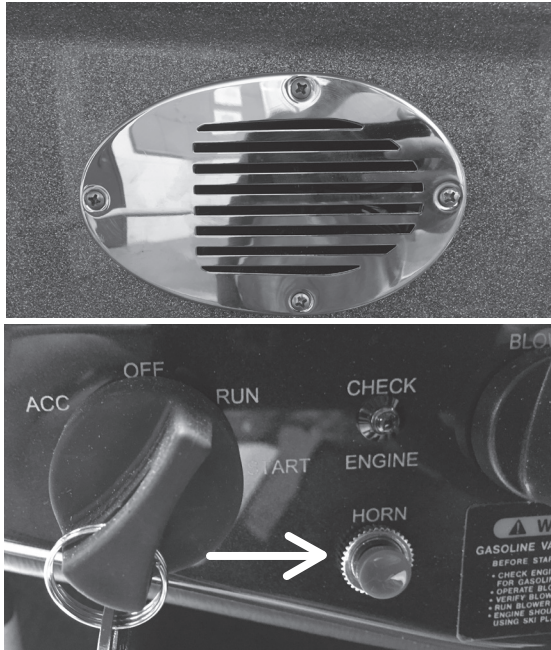

The Horn Switch is located on the switch panel to the left of the steering wheel.

Horn / Whistle Signals

One Long Blast:

Warning Signal (Coming out of slip)

One Short Blast:

Pass on my Port Side

Two Short Blasts:

Pass on my Starboard Side

Three Short Blasts:

Engines in Reverse

Four or More Blasts:

Danger Signal

1. **OVERTAKING / PASSING:** Boat being passed has the right-of-way. **KEEP CLEAR.**
2. **MEETING HEAD-ON:** Keep to the right.
3. **CROSSING:** Boat on the right has the right-of-way. Slow down and permit him to pass.

BALLAST TROUBLE SHOOTING GUIDE

Problem	Possible Cause	Action	Correction
Pump turns on, but does not pump water	Pump not priming	1)Water intake ball valves are not open 2)Kink in hose 3)Impeller worn Check ballast power wires at the PDM	1)Open ball valves 2)Check hoses for kinks and straighten as needed 3)Check hose connections and tighten if loose. 4)Replace Impeller
Pump will not turn on	System needs reset	Check power to all areas	Turn power off to the system at the breaker and then back on and test pump
Pump will not turn on	Ballast breaker is tripped	Check 60 amp ballast breaker at the engine compartment	Reset ballast breaker
Pump will not turn on	Ballast power wires not connected to PDM	Check ballast power wires at the PDM	Connect power wires to PDM

CAUTION

When bags begin to vent, shut off the pump!

WARNING

DO NOT OVERFILL BALLAST BAGS!

Moomba 2018 Ballast Times

Boat Model	Front Ballast Time	Rear Ballast Time
Helix (Std Ballast)	4 minutes	6 minutes
Helix (Add IBS)	9 minutes	6 minutes
Mondo (Std Ballast)	4.5 minutes	6 minutes
Mondo (Add IBS)	10 minutes	6 minutes
Max (3 Pumps)	11.5 minutes	9.5 minutes
Max (6 Pumps)	6 min 30 sec	5 min 30 sec
Craz (3 Pumps)	11.5 minutes	9.5 minutes
Craz (6 Pumps)	6 min 30 sec	5 min 30 sec
Mojo (3 Pumps)	11 min 30 sec	9 min 30 sec
Mojo (6 Pumps)	6 min 30 sec	5 min 30 sec

CAUTION

Be careful of the articulating hinge. Do not place fingers or other objects in the hinge mechanism during use.

The driver's seat may be adjusted forward or backward by moving the lever below the left of the seat. Use body pressure to move the seat to the desired position. Release the lever then check to feel the seat lock into place.

The driver's seat will swivel and lock into 3 positions. The release lever is located below the left of the seat.

CAUTION

After adjusting the seat, be sure that it has locked into place by pushing forward and backward until it has securely latched.

DO NOT attempt to adjust the driver's seat while the boat is moving.

DRIVER'S SEAT & SEAT ADJUSTMENT

The Rise-R Seat is a unique driver seat enhancement. The front edge of the driver's seat cushion lifts up to give the driver a taller sightline.

To switch the seat to the raised position, use two hands to lift and push the front edge of the seat cushion up and back until it is sitting on the rear half of the driver's seat cushion.

To switch to the lower position, use two hands to push the Rise-R seat cushion forward and down.



SKI PYLON - HELIX / MONDO MODELS



The ski pylon is only to be used to pull skiers. **DO NOT use the ski pylon to hoist the boat.** Only use the lifting rings for this purpose.

NOTE: With use the ski pylon may loosen. Should this occur, see your Moomba Dealer for service.

WARNING

The use of pylon extensions can severely effect the overall handling of the boat. Follow pylon extension manufacturer's directions for mounting.

DO NOT mount any Pylon Extension on the rear pylon (located at the rear).



WARNING

- AVOID SERIOUS INJURY OR DEATH.
- TOW PYLON SHOULD BE USED ONLY FOR TOWABLE WATER SPORTS DEVICES.
- DO NOT USE TOW PYLON FOR OTHER TOWABLE OBJECTS OR TOWING BOATS.
- TOW PYLON IS NOT DESIGNED FOR VERTICAL EXTENSIONS. ANY MODIFICATIONS TO THE TOW PYLON OR ITS MOUNTINGS MAY RESULT IN DAMAGE TO THE BOAT AND INJURY TO THE USER.
- DO NOT SIT BEHIND THE TOW PYLON WHEN IN USE.

WLSKP0803

V-DRIVE ENGINE COMPARTMENT



To access the engine compartment, pull to raise the center sun deck lid. When the ski lockers and engine compartment lids are closed, the upholstered lids double as a cushioned sun deck.

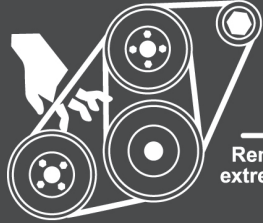

Pulley & Belt Warning!
Pulleys and belts can cause severe injury! Never open the motor box while the engine is running or while the boat is underway!

Remember, after running, the engine is extremely hot and should not be touched or repaired until it has cooled.

TOWER



Moomba models are equipped with a Moomba A3 towing tower. The towers are designed with practicality, aesthetics, and the consumer in mind. 2-3/8 in. tubing is used to provide additional strength and stability to enhance the performance and functionality of the tower. The larger diameter tubing also allows for the possibility of four wakeboard/surfboard racks to be mounted (two on port side, two on starboard side). The fold assist feature make it easier to raise or lower the tower (two individuals working together is recommended). The Moomba A3 towing tower is NOT intended to be used to tow skiers, barefooters, tubes, or multiple wakeboarders. Such use will void any warranties written or implied.

⚠ WARNING

Be sure that all bolts are tightly in place before use.

⚠ WARNING

Be aware of and avoid low overhead objects such as bridges, power lines, overhanging trees, etc.

To LOWER TOWER FOR STORAGE:

Using two people, rotate the roll-loc handles to release the tower and lower the tower downward into the boat.

CAUTION

The tower must be supported when Roll-Locs are released, or the tower can fall into the boat injuring passengers or damaging the boat. Rotate the driver's seat to avoid damage from lowering the tower.

To RAISE TOWER:

Lift the tower and rotate handles toward the back to lock into place. This will secure the tower in the upright position.

WARNING

- Failure to follow these warnings while using the tower could cause serious injury or death.
- Lock the tower in place and secure all hardware before and during use.
- Do not tow more than 1 persons or 500 pounds at one time from this tower.
- Only use this tower for waterskiing, boarding, or recreational towables.
- Do not use this tower for parasailing, kite flying, pyramids, group pulls, towing other boats, or tubes.
- Do not climb on, sit on, stand on, jump off of or dive off of the tower.

FIRE EXTINGUISHER



OPTIONAL FIRE SUPPRESSION SYSTEM

The optional Automatic Fire Suppression System has a sensor in the engine compartment that is designed to detect a fire. Under normal conditions, the dash area warning light will glow green when the ignition is "ON". If the engine compartment sensor is activated by a fire, it will deploy the content of its fire extinguisher and the dash mounted warning light will turn red.



A standard Coast Guard approved fire extinguisher is provided on all Moomba boats. The fire extinguisher is located on the port side behind the observer's seatback.

(Refer to label instructions for use.)

TOWER ANCHOR/RUNNING LIGHT



On boats equipped with factory installed towers, the 360° White Anchor/Running Light is mounted on the tower.

NOTE: If your boat is not equipped with a tower, a pole style light is required.

Bow LIGHT

The bow light is located on the forward deck. To alert other boaters to your position and direction while underway at night, the light is green on the starboard side and red on the port side. To replace the bulb, remove Phillips screw to lift cover.

Some Moomba models use LED forward lights. These lights do not have replaceable bulbs.

Bow EYE

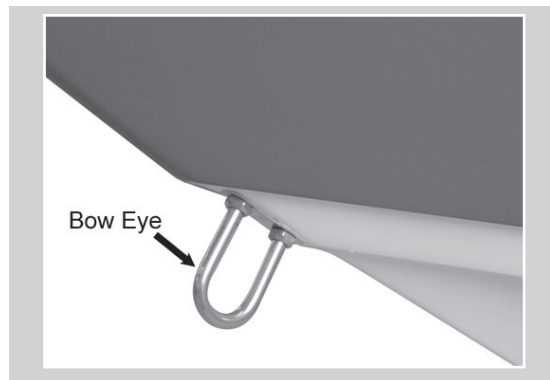

The bow eye is located at the front of the hull below the rub rail. It is the point of attachment to lead the boat onto the trailer and to secure the boat to the trailer or to a tie-off when docking.

NOTE: See Hoisting Instructions before using the bow eye to hoist the boat.



DO NOT use the bow eye ONLY to hoist the boat. You must use a sling with the bow eye when hoisting the boat. Use only the designated lifting rings to hoist the boat. (See Hoisting Instructions.)

LIFTING RINGS



Two lifting rings are located on the transom.

NOTE: The lifting rings should be the only point of attachment for lifting cables. (See Hoisting Instructions.)

POP-UP CLEAT

To use the cleat, pull center up.



WARNING

DO NOT tow objects with the cleats.



STANDARD DETACHABLE PLATFORM

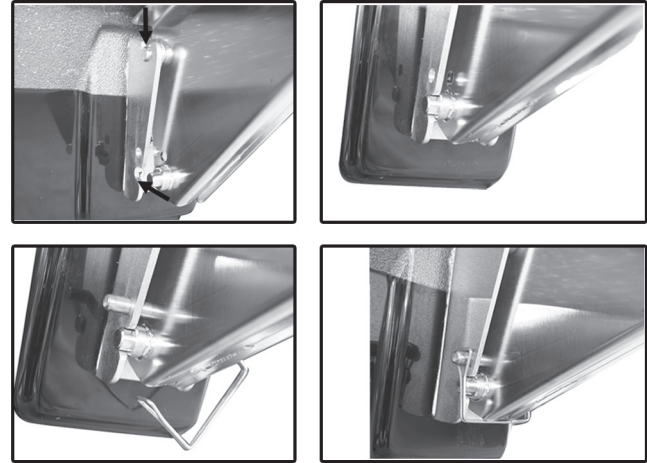

The ski platform is attached to the boat with detachable brackets. The platform may be removed from the boat by

1. Set platform on bracket.
2. Locate lower pin.
3. Locate locking pin through brackets.
4. Swing locking arm over end of pin.

To reinstall, reverse the removal procedure.

STANDARD PLATFORM



All Moomba models are equipped with a ski platform on the stern. The platform allows easy access to and from the water for skiers and swimmers. It is recommended that all entries to and exits from the water be made from the platform to avoid accidents. (The fiberglass deck can become slippery when wet.)

DANGER

Shut Engine OFF when people are on the platform or in the water near the platform.

DANGER

Exhaust fumes contain carbon monoxide. Direct or prolonged exposure to carbon monoxide will cause brain damage or death.

PROPELLER

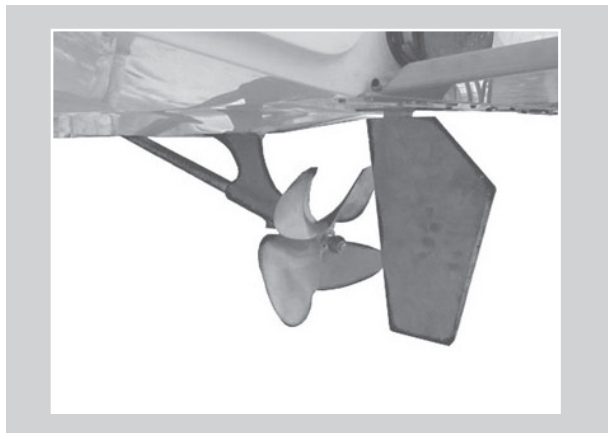

The product development team at Skier's Choice has carefully explored and tested many different propellers and pitch angles for use on Moomba boats. All tests indicate that the current propeller installed on your model is the best for the variety of boating performance required.

It is strongly recommended that your Moomba dealer be notified before changing the propeller. In general, changing to a lower pitched propeller may increase acceleration, but will decrease top speed. Changing to a higher pitched propeller may achieve higher top speed with a light load, while acceleration and power may decrease.

WAKEPLATE



The multisport wakeplate allows the driver to control the running attitude of the boat.

PROPELLER PRECAUTION

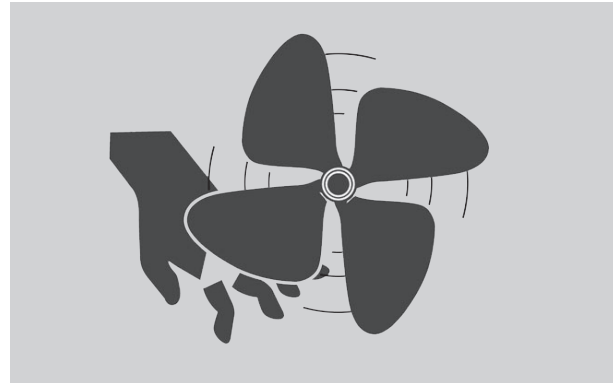

WARNING

A moving propeller will cause injury. Propeller may rotate with boat in neutral. Shut off the engine when people are on the platform or in the water near the boat to avoid injury from the prop.

NOTE: Under no circumstances should a propeller which allows the engine to surpass recommended RPMs be installed.

CAUTION

Avoid engine damage, do not exceed the Max RPM as listed for your motor. Some props may allow the engine to over-rev which can cause non-warrantable engine damage.

TRIM SWITCH AND WAKEPLATE



WAKEPLATE TRIM GAUGE

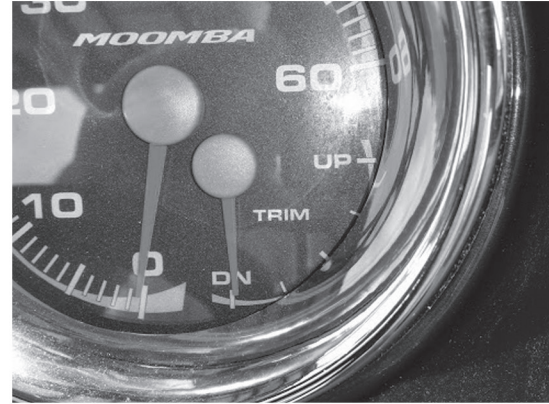

The Wakeplate switch controls the position of the center trim tab (wakeplate). The corresponding trim gauge indicates the position of the wakeplate. The down position raises the stern of the boat and lowers the bow. The wakeplate helps shape the wake for surfing and wakeboarding.

Section 10

Service & Maintenance

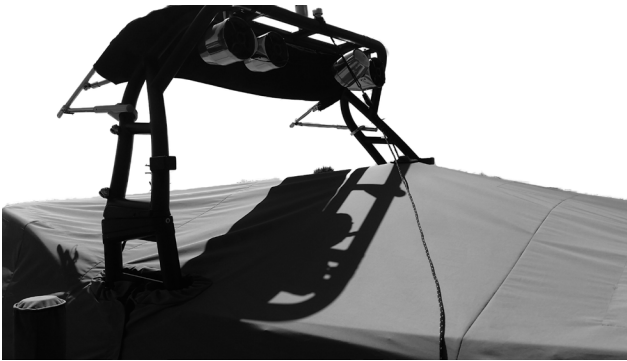

Your Moomba boat cover is made from the finest material and webbing to ensure that your boat will be protected in the off season. The cover has been designed to fit securely around each boat. If your new cover does not seem to be snug, a shrinkage allowance has been sized in.

Use the following procedure when covering the boat:

- Be sure that the cover fits snugly at the bow then unfold from front to back.
- Be sure to install cover pole(s) and adjust to proper height. This will keep water from gathering in the center, which can damage the cover.
- Pull the draw cord equally from both sides and tie off to the lifting eyes on the stern.
- Place hangtyte rope overtower ski pole and draw cover tight by pulling the rope.

Folding Cover

When folding the cover for storage, be sure the cover is dry. Take care not to scratch the finish against rough surfaces. Store in a dry location.

Cover Repair

If the cover becomes damaged, immediately patch and reseal the area. Use a tent seam sealer to reseal any new stitches. Spray fabric guard on scraped or worn surfaces. Tears should be repaired professionally and stitches sealed to prevent leakage.

CAUTION

Your mooring cover is not designed for trailering. Trailering with your cover installed may cause premature cover failure and boat damage. This damage is not warrantable.

OPTIONAL WALK-THROUGH WINDSCREEN

Some Moomba models offer an optional Walk-Through windscreen that slides into the front walk-through to help prevent cold air from flowing into the cockpit area.

OPTIONAL TOWER SPEAKERS

The optional tower speakers are an additional set of speakers designed to allow the rider to be able to hear the music. The tower speakers require the addition of an amplifier to power the speakers.

CAUTION

Some lakes have noise restriction ordinances. The use of tower speakers may not be allowed in your area. Please check all applicable laws in your area regarding noise level restrictions.

OPTIONAL SUBWOOFER

The optional sub-woofer is designed to increase the sound level of the bass notes. The optional amplifier powers the sub-woofer. The bass level can be adjusted on the amplifier. Please see stereo amplifier owner's manual for more information.

OPTIONAL STEREO AMP

The stereo amplifier is an optional piece of stereo equipment that is designed to increase the wattage of the signal going to the speakers while minimizing distortion of this signal. Please see stereo amplifier owner's manual for more information.

CAUTION

Using a stereo amplifier without the boat engine running may drain the battery to the point where the boat will not restart. This condition may happen very quickly, depending on the size of the battery!

WARNING

It is illegal to wakeboard, ski, tube, etc., after sunset and before sunrise in most states. It has been outlawed because it is dangerous. Tower lights do not make these activities legal or safe.

OPTIONAL DOCKING LIGHTS

The optional docking lights are designed to help you dock, load and unload your boat in low light or at night.

NOTE: Docking lights are not to be used as running lights at night. USCG regulations mandate that a boat under power after sunset must display a 360 degree white light and a red/green bow light.

OPTIONAL ENGINE WATER STRAINER AND FLUSH

The optional Engine Strainer and Fresh Water Flush kit has a valve specifically designed to allow you to attach a garden hose to your engine water intake to flush brackish or salt water out of your engine. To use the Fresh Water Flush, simply attach a garden hose to the valve. Turn on the water to the valve. Start the engine. Monitor the exhaust ports on the transom of your boat and engine temperature gauge. Water should come out of the exhaust ports while the engine is running. It is recommended that you run the engine at a low RPM while flushing, since the engine's raw water pump at higher RPMs can pump more water than the garden hose can supply. If you have questions on the operation of your Fresh Water Flush kit, consult your Moomba Dealer.



The optional engine water strainer is a filter for the engine cooling water. It is recommended for boats that are going to be operated in weedy conditions or other areas where debris could clog the engine. It consists of a stainless steel mesh filter inside a clear cup. It is located between the water intake on the bottom of the boat and the engine's raw water pump. It should be checked periodically for debris as conditions dictate. To remove debris, unscrew the clear sight cup, remove the o-ring and stainless steel filter mesh and proceed to rinse out the cup. Be sure to reinstall the filter mesh and o-ring before reattaching the sight cup to the inlet.

OPTIONAL WAKEBOARD RACKS



OPTIONAL BOAT HEATER



The boat heater is a forced air heater that uses hot engine water as a heat source. To use the heater, simply turn the heater switch to the selected fan speed. In order for the heater to work, the engine must be at operating temperature. One of the features of the heater are the snorkel vents, which can be pulled out to direct heat to specific areas.

NOTE: Location may vary by model.

BATTERY CABLE INSTALLATION & PRECAUTIONS



BATTERY SPECIFICATIONS

**12 Volt Marine Type Battery
with tapered post connectors**

Engine Size	Cold Crank @ 0° F (-18° C)
6.2L	Minimum of 650 amps

A high Quality Series 24 Marine Dual Purpose Battery is recommended.

Your battery is an important part of your boat. It provides all of the power to start your boat and also allows all of your electrical components to work, even if the motor is not running (bilge pump, blower, stereo, etc.).

Because of its important role, Moomba recommends using a good quality “Marine Dual Purpose” battery. The “Dual Purpose” rating means that it can provide the cranking Amps needed to start your motor and also has an Amp hour discharge rating so it can handle low electrical draw -down cycle.

Your Moomba electrical system is negative ground. The negative battery cable is grounded on the engine block. The positive battery cable is connected to the starter solenoid.

CAUTION

Failure to connect battery cables as outlined will damage the system and void the warranty.

SINGLE BATTERY (STANDARD) HOOKUP

The standard battery hookup is very similar to an automotive application. There is one red battery cable that connects to the positive (+) battery terminal and one black cable that connects to the negative (-) battery terminal. The positive cable from the battery goes to a power switch which allows you to turn power on or off to the dash components and engine. The stereo memory and bilge pump power will not be terminated by selecting the off position on the battery switch.

CAUTION! - Do not turn the selector switch to the "Off" position when the motor is running. The alternator will be permanently damaged and is not covered under Skier's Choice or Indmar warranty.

NOTE: It's recommended that you fully recharge your batteries using a battery charger periodically or after a period of high discharge (running many accessories for an extended period of time).

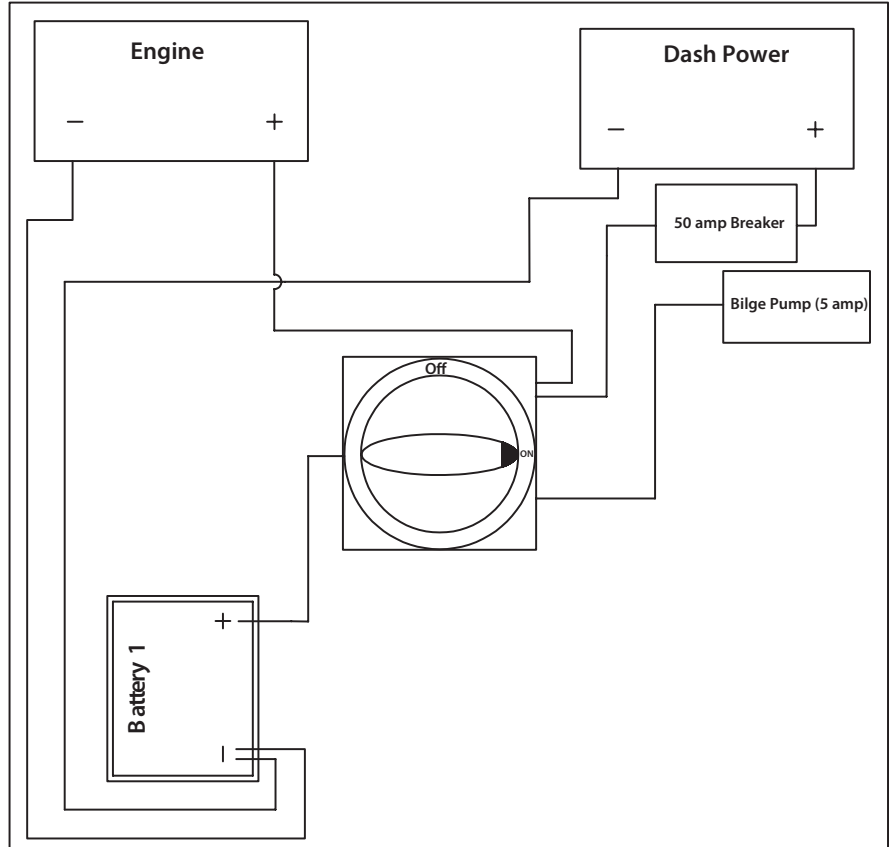

DUAL BATTERY (OPTION) HOOKUP

Skier's Choice installs a 4-position battery switch on any boat equipped with dual batteries. It is recommended that both batteries be fully charged between each use to insure they can deliver the electrical demands required for each outing. The purpose of our recommendation is to utilize one primary battery for all operational needs, and have the other as a backup if the primary battery discharges. This situation could occur if you run your accessories such as ballast or stereo for a long time without running the boat. The dual battery setup is designed to create a redundant system allowing the user to have a backup battery. The switch must be in the "1" or "2" position to create the redundancy.

The 4 positions available on the battery switch are: Off / 1 / 2 / 1&2. These choices indicate which battery is being used to power the boat and is being charged by the engine's alternator. We recommend using only position 1 or 2 while boating.

Battery switch position "1&2" is available but not recommended as power will be drawn from both batteries and the alternator will have difficulties keeping both batteries charged simultaneously. It also creates a ground differentiation which in turn will create issues with sensitive electrical components such as the dash screen. The only time you may need Position 1 & 2 would be in an emergency situation where both batteries are low and need power from both to help start the engine.

To properly hook up the two batteries;

1. Connect the grounding strap provided from the negative (-) post on Battery 1 to the negative (-) post on Battery 2.
2. Connect the negative (-) cable from the grounding bus bar to the negative (-) post on Battery 1.
3. Connect the negative (-) cable from the engine to the negative (-) post on Battery 1.
4. Connect the positive cable from the left side of the battery switch to the positive (+) post on Battery 1.
5. Connect the positive cable from the bottom of the switch to the positive (+) post Battery 2.

Battery 1 is designated as the primary battery and Battery 2 is designated as the secondary battery.

CAUTION! - Do not turn the selector switch to the "Off" position when the motor is running. The alternator will be permanently damaged and is not covered under Skier's Choice or Indmar warranty.

It is highly recommended that Position "1" be used in most situations so the secondary battery will be available to start the engine from Battery 2 (secondary) if necessary.

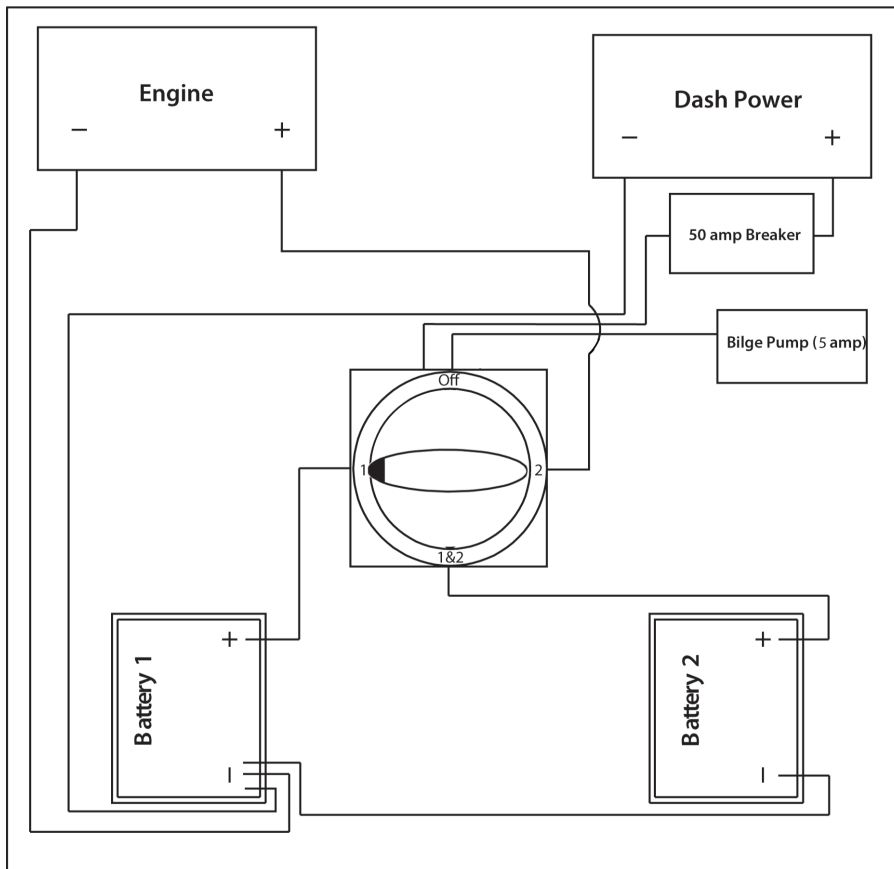

Be aware that if position "1&2" is selected, both batteries will drain power at the same time and could leave you stranded due to weak batteries.

NOTE: It is recommended that you fully recharge your batteries using a battery charger periodically or after a period of high discharge (running many accessories for an extended period of time).

NOTE: Skier's Choice highly recommends using quality "Dual Purpose" batteries.



⚠ WARNING

Hydrogen and oxygen gases are produced during normal battery operation and charging. Sparks or flames near the battery vent openings can cause the mixture to ignite and explode.



⚠ WARNING

Sulfuric acid in the battery can cause serious burns. If spilled on skin or in the eyes, flush with clean water immediately, then seek medical attention.

Typical V-Drive

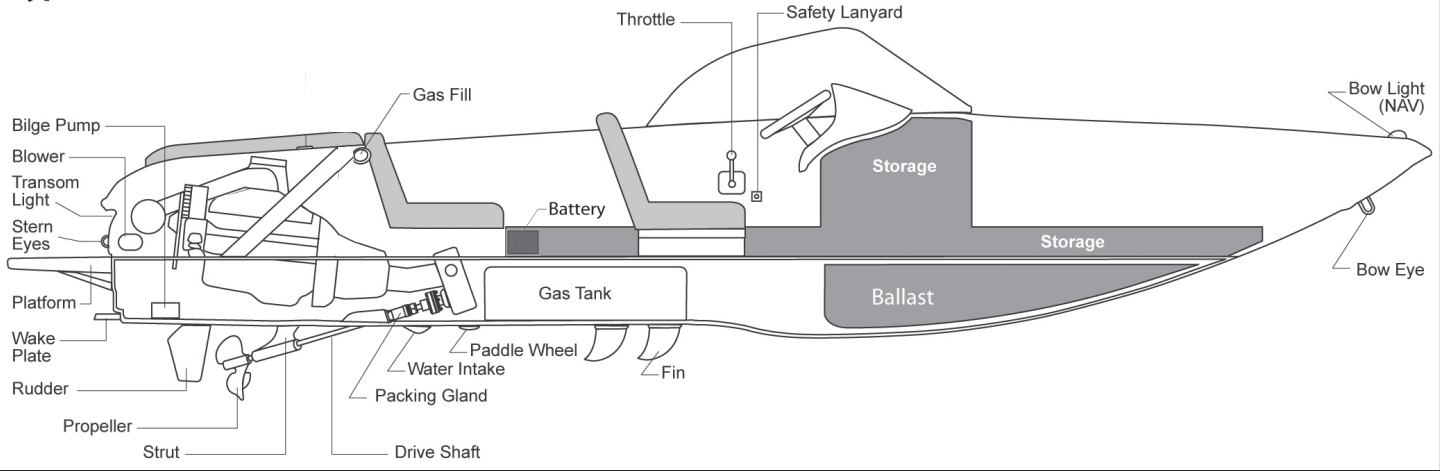

The illustration above denotes the areas which may need to be accessed or may require cleaning or maintenance. It is important to have a basic understanding of the parts and their locations on the boat. However, it is recommended that any service beyond routine maintenance be performed by an authorized Moomba dealer.

SERVICE & MAINTENANCE

For your convenience a maintenance chart has been included in this manual. The chart indicates when to perform safety checks, lubrication, and general service to the boat. Engine hours or elapsed time determine when service is necessary.

It is recommended that any replacement parts used during maintenance or for repair be supplied by an authorized Moomba dealer.

NOTE: You are responsible for keeping records of all maintenance on your boat. To maintain your new boat warranty, you may be asked to show that required maintenance was performed.

Maintenance Intervals @ Engine Hours

Maintenance To Perform	Weekly	1st 25	50	100	Yearly
Check Fuel Lines & Connections for Leaks	X	X	X	X	X
Ballast - Impeller Replacement				X	X
Check Battery Electrolyte Level		X	X	X	X
Check All Electrical Connections	X			X	X
Check Cooling System Hoses for Leaks	X	X			X
Tighten Engine Mount Fasteners					X
Lubricate Shift Linkage Pivot Points					X
Check for Loose, Damaged or Missing Parts	X	X			X
Check Engine to Prop Shaft Alignment		X		X	X

* If engine overheats, visually check. If clogged, remove debris.

This inspection and maintenance schedule is recommended for average operating conditions in normal service.

Under severe operating conditions or service, intervals should be shortened.

NOTE:

**REFER TO INDMAR ENGINE MANUAL FOR ENGINE, TRANSMISSION AND V-DRIVE
MAINTENANCE SCHEDULE AND PROCEDURES.**

***BODY LUBRICATION**

Normal use of your Moomba causes metal to metal movement at some parts in the boat. The driver seat track should be lubricated with a water resistant chassis lubricant such as silicon grease.

V-DRIVE LOCATION

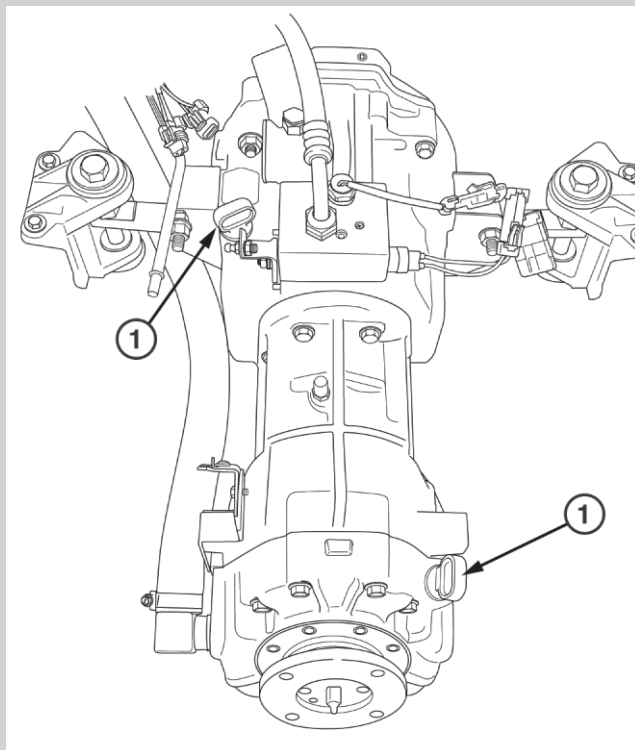

The fluid level can be checked by using the oil level dipstick, which is located on top of the V-Drive transmission. This unit's located under the center cushion of the rear seat. Pull out the cushion to access the transmission.

PROPELLER WARNING

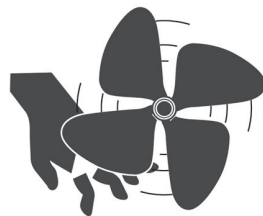

⚠️ WARNING

Moving propeller will cause injury. Propeller may rotate with boat in neutral. Shut off the engine when people are on the platform or in the water near the platform to avoid injury from the prop rotation.

DRIPLLESS SHAFT SEAL

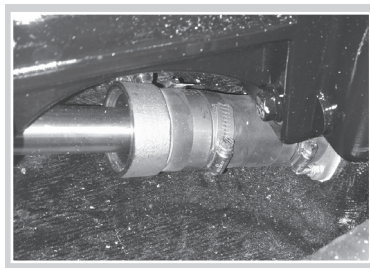

Your Moomba comes standard with a dripless shaft seal. If any seepage occurs, contact your dealer.

Section 11

Cleaning, Care & Storage

FIBERGLASS CARE

Washing and waxing the boat hull and deck regularly will extend the life and beauty of your Moomba. It is a good routine to rinse your boat with fresh water after each day's use.

It is recommended that the hull and deck be cleaned and waxed after every 50 hours of use. This will decrease water friction and lessen the potential for staining or spotting on the gel coat surface.

When the original gel coat shine cannot be restored by waxing, the shine may be restored by hand buffing with a commercial polishing compound. Be sure to apply a new coat of wax containing Carnauba over the area that has been polished.

IMPORTANT: Porcelain cleaning powders are too abrasive for use on gel coat and may cause permanent discoloration if used. Household detergents containing ammonia or chlorine should not be used on gel coat. Never use acetone or ketone solvents to clean your boat finish.

WASHING YOUR MOOMBA

The easiest way to preserve the beauty of your boat is to keep it clean by frequent washing. Wash the boat with luke warm or cold water. Wipe the boat down immediately after washing to avoid water spots. Avoid using hot water or washing your boat in direct sunlight. Avoid using strong soaps or chemical detergents. To avoid spotting, all cleaning agents should be thoroughly rinsed from the surface promptly and not allowed to dry on the finish.

RUB RAIL CARE

Use a sponge or other soft material to wash and wax the rub rail. To wax, use a commercial automotive bumper wax.

NOTE: When tying up to a dock or another boat, always use cushioned fenders (dock bumpers) to protect your boat from hard surfaces.

WINDSHIELD CARE

Clean the windshield regularly to ensure that visibility is not obstructed. Use a commercial glass cleaner to remove any spotting or stubborn stains that develop on the windshield. Never use abrasive cleaners on glass or plastic surfaces as they may cause scratches.

UPHOLSTERY CLEANING

All upholstery items on your boat are made of tough marine grade vinyl that is easily cleaned with a mild detergent.

Strong detergents and cleaners may shorten the life of the vinyl. PLEASE SEE VINYL MANUFACTURER'S RECOMMENDED CARE GUIDE INCLUDED IN YOUR OWNER'S PACKAGE. Always rinse cleaning chemicals off with clean water. Failure to do so will result in cracks in the vinyl which is not covered by warranty.

The best cleanser is mild soap and warm water followed by rinsing with fresh clean water.

FOREIGN DEPOSITS

Tree sap, bird droppings, airborne chemicals, petroleum products and other foreign matter may damage the gel coat surface if not removed promptly (See Washing Instructions).

Boat Hull Protection

If your Moomba is to remain in the water for an extended period, the hull below the water line should be painted with a marine bottom paint. Boats left in the water for extended periods of time without bottom paint may experience blistering or discolorization. This type of damage is not covered by your boat's warranty.

DRYING UPHOLSTERY

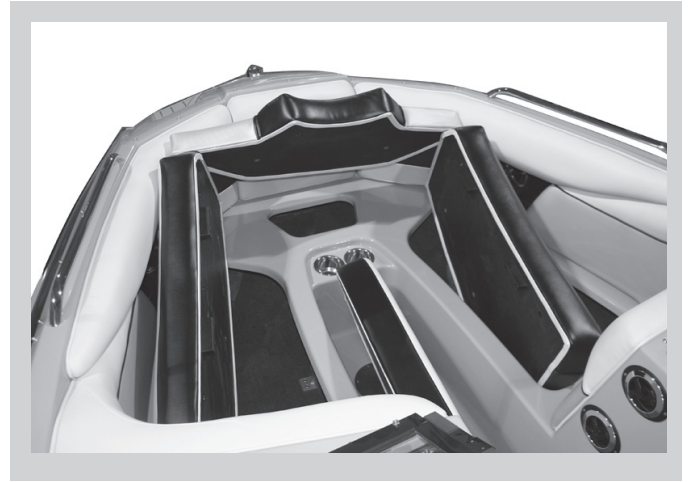

It is important to provide for the drying of all upholstery and carpet after each use of the boat. Open all storage compartments and slide all removable cushions out about an inch to allow air to circulate behind. If cushions are wet, turn them up at an angle as shown above to promote drying.

Improper drying of your cushions can attract mold spores under the vinyl which develop pink or blue stains depending on the type of mold. These stains are not covered under the limited warranty.

CAUTION

Damage caused by improper care, cleaning agents, conditioner oils, waxes, gasoline, etc., IS NOT covered under your boat's warranty. Use only the recommended vinyl cleaner as listed on the Vinyl Care Instruction Sheet.

Please refer to www.spradlingvinyl.com for more information regarding vinyl care.

WET SLIPPING BOATS

CAUTION

- In the event of large storms, boats in wet slips are more likely to be damaged.
- If you do not use the boat often, the battery can go dead from pumping out water.
- The boat may develop organic growth which can greatly reduce performance, attack and discolor the gelcoat.*
- The boat may develop osmotic blisters.*
- The boat may get a stain line which cannot be removed.*

** Painting the area below the waterline of the boat with Pettit or Interlux products will reduce the likelihood of these last three.*

WINTERIZATION

When the boating and ski season comes to a close, it is important to have your boat professionally winterized.

If your boat is exposed to temperatures below 32 degrees F (0 degrees C), it is possible for water in the engine, ballast system, heater core, etc., to freeze. As this water freezes, it expands and can crack pumps, valves, heat exchangers, engine blocks, etc. This type of damage usually requires the replacement of the cracked item and can be very expensive to repair.

CAUTION

It is extremely important to follow the proper winterizing procedure. The engine must be correctly winterized for safe storage in your climate. This should be done by a professional. Your Moomba dealer will know exactly what must be done to ensure the longest possible life for your boat.

In addition to having your boat professionally winterized, the following tasks should be done to protect your boat during storage:

- Remove the center and transom drain plugs from the boat.
- Thoroughly clean the boat inside and out. Inspect the hull for any residue or algae growth and remove if required.
- Clean the bilge area thoroughly and operate the bilge pump to remove any water from the bilge hose.



- Remove all seat cushions and open all storage areas to allow air circulation in the boat interior.
- When thoroughly dry, replace cushions and close storage areas.
- Top off fuel tank to prevent any condensation from accumulating in the fuel system. Use a commercially available fuel stabilizer to remove water and prevent gumming.
- If the boat is stored on its trailer, ensure that the boat is properly positioned. If possible, lift the tongue so that the bow is slightly raised to promote drainage from the drain hole.
- Install the canvas cover and secure the straps in accordance with cover instructions.

NOTE: During the winter months, water is a boat's worst enemy. Always store the boat when the interior is completely dry. Periodically check on the condition of the stored boat.

CAUTION

Damage due to improper winterization IS NOT covered under your boat's warranty.

CAUTION

E-10 fuels require fuel stabilizers that are specifically designed for E-10 fuels to help prevent moisture absorption, phase separation and gasoline stabilization.

SUMMERIZATION

Before using the boat after it has been in dry storage requires some special treatment. Moomba recommends having your boat professionally summerized, preferably by the same facility that prepped it for storage. They will be familiar with what items were done in the fall and what items need to be addressed in the spring.

In addition to having your boat professionally summerized, the following list of tasks should be done to ensure a successful start to your boating season.

- Check Trailer
- Tire Pressure
- Brake Fluid
- Lights

- Check Battery
- Clean & Wax Gelcoat
- Clean Interior

- Check All Systems
- Blower
- Bilge Pump
- Navigation Lights

When launching the boat for the first time of the season, carefully watch all gauges to ensure that the boat is not overheating, the alternator is charging and the engine has proper oil pressure.

NOTE: It is recommended that the battery cables be disconnected from the battery when the boat is placed in storage. (Refer to Battery Cable Installation and Precautions)

HOISTING

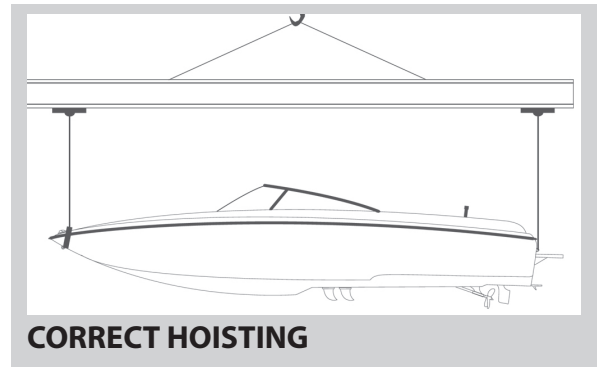

HOISTING

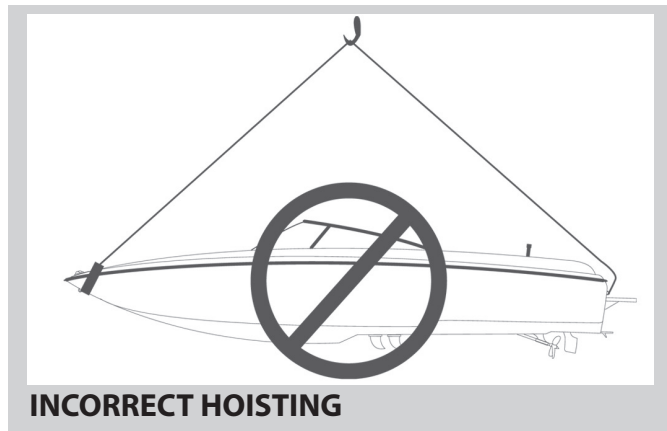
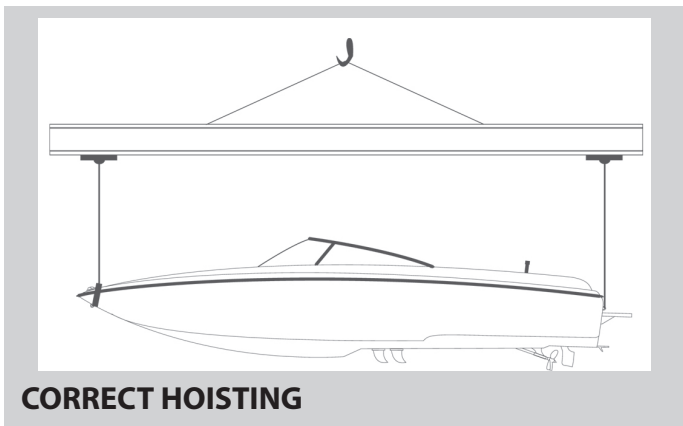

If the boat ever needs to be hoisted, special attention should be given to the following recommendations:

- Hoist the boat using a horizontal lifting bar only.
- Never attempt to lift the boat by means of a cable sling from bow to stern lifting eyes.
- Hoist operator should slowly and smoothly lift the boat without jerking to avoid damage to the lifting eyes.
- Use a clevis inserted through the lifting eye since a hook may damage the lifting eye edges.

CORRECT HOISTING



WARNING

DO NOT use the ski pylon if equipped to hoist the boat. Incorrect hoisting may invalidate the warranty on the boat.

WARNING

Use only a proper sized sling in the designated lifting rings to hoist the boat.

NOTE: For boat houses or other applications where the boat will be lifted and held in that position, Moomba recommends using a cradle. The bunk configuration should mimic the trailer.



Section 13

Technical Information

IDENTIFICATION NUMBER



The hull identification number is located on the upper right hand side of the transom below the rub rail.

HEATER FUSE

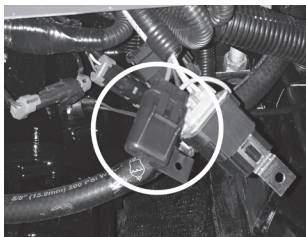

	Breakers, Fuses & Relays	Type	Size (amps)	Location
Fuse Block	ECM	ATM	10	On Engine at Transmission
	Fuel Pump	ATM	20	
	Fuel Pump 2	ATM	20	
	Fuel Pump Relay	Relay	NA	
	Helm	ATM	20	
	Main	MAX	40	
	Power Relay	Relay	NA	
	PTR	ATM	30	
	Starter	ATM	20	
Ignition	ATM	10		
Battery Switch/ Power Board	Main Buss Bar	ANL	200	Observer's Storage
	Amp Harness (5 Channel)	MAX	100	
	Amp Harness (4 Channel)	MAX	30	
	Amp Harness (2 Channel)	MAX	40	
	Amp Fuses	ATO	20x2	
	Amp Fuses	ATO	30	
	Amp Fuses	ATO	30x3	
	Main Dash Breaker	Breaker	50	
Automatic Bilge Pump Fuse	ATO	5		
Breaker Panel	Ignition	Breaker	10	Under Dash
	Bilge Pump	Breaker	5	
	Blower	Breaker	4	
	Acc 1	Breaker	10	
	Nav/Anc Lights	Breaker	5	
	Courtesy Lights	Breaker	5	
	Docking Lights	Breaker	10	
	Underwater	Breaker	3	
	Stereo	Breaker	15	
	Horn	Breaker	4	
	12v Receptacle	Breaker	15	
	Heater	Breaker	15	
	GPS/ Inclinometer	Breaker	3	

Main Dash Power- Circuit Breaker

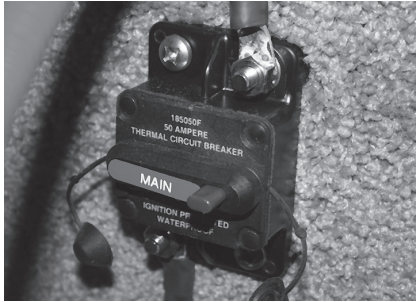

The power to the dash circuit is protected by a circuit breaker that is located in the observer seat storage area near the battery.

To turn off the power to the dash, manually press the red button and the circuit breaker reset lever will flip down and the power to the dash circuit will be shut off. To reset the breaker, push the reset lever back up.

If all of the dash switches fail to work, reset the main dash power-circuit breaker.

Fuse Panel - Top of Engine

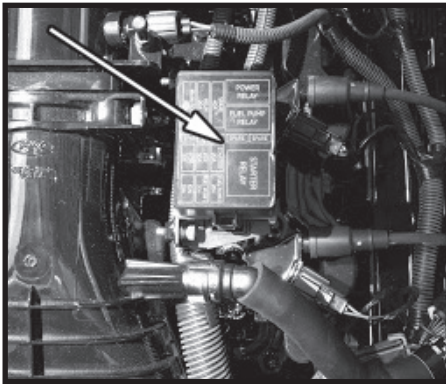

Ballast Power- Port Side Engine Wall

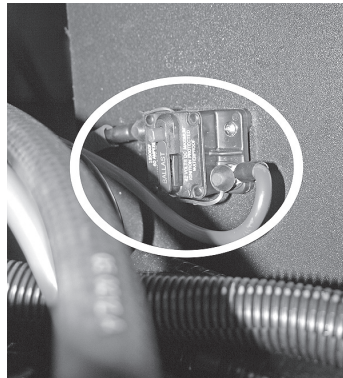

Automatic Bilge Pump Fuse- Observer's Storage



Section 14

Trailing Your Boat

TRAILER & TOWING



The trailer supplied with your Moomba model was designed especially for the boat with your convenience in mind. Please be sure that you have an appropriate tow vehicle before attempting to trailer your boat. Your vehicle must be capable of towing 4,500 — 6,000 lbs., depending on the model.

CAUTION

Read the trailer towing section of your vehicle owner's manual before towing your trailer.

All Moomba trailers require a 2" ball and a five (5) pin marine grade trailer wiring connector. The standard height from the ground to the top of the hitch ball should be about 22 inches. With the trailer attached to the tow vehicle, the trailer should stand level.

Trailer Plug Wire Schematic

White: Ground

Green: Right Turn/Brake

Yellow: Left Turn/Brake

Brown: Running Lights

Blue: Reverse Lights

NOTE: Moomba trailers feature disk brakes. The fifth wire (blue) on the wire connector needs to be connected to your vehicle's reverse lights to be operative. This wire (blue) provides power to a solenoid which deactivates the brakes while in reverse. You may still tow your trailer without the blue wire connected, however, you may experience difficulty backing the trailer.



BEFORE USE, READ ALL INFORMATION SUPPLIED WITH THE TRAILER BY THE MANUFACTURER.

The following guidelines will prolong the life of the boat and trailer:

1. Always secure the boat to the trailer with tie-downs. Do not place straps around fenders or lights.
2. Always verify that the winch hook is securely in the bow eye, the strap is tight and the winch handle locked in place before trailering.
3. Check the recommended pressure displayed on the side of the tires and assure that it is maintained.
4. Under-inflated tires could cause trailer sway and excessive tire wear.
5. Verify that the trailer hitch on the tow vehicle is the proper class and size to support the tongue weight and the trailer load.

CONNECTING THE TRAILER



NOTE: If your hitch ball has an excessive flat spot on top, the latch may not engage properly. If the latch does not catch, check with your dealer or hitch installer before trailering.

When connecting the trailer to your tow vehicle, use the following procedure:

1. Raise the tongue with the trailer jack, position the trailer tongue directly over the 2" ball, and lower the jack until the tongue goes all the way down over the ball.
2. Press down on the latch until it locks on the ball with a "click."
3. Insert the locking pin into the tongue. Lock pin hole is on the side of the tongue.
4. When all weight is off the trailer jack, pull the jack lock pin and rotate the jack to the horizontal position and re-lock the pin.
5. Attach the safety cables to the tow vehicle hitch. Cross the cables and wrap them around each other once or possibly twice allowing just enough slack to permit tight turns of the vehicle and trailer.
6. Plug the trailer lights connector to the vehicle harness.
7. Clip the brake lockout cable to the vehicle hitch.

UNLOADING PROCEDURE



NOTE: DO NOT attempt to use excessive power to free the boat from dry carpet runners. Power off of the trailer only when the boat has floated free.

CAUTION

If the trailer is not submerged to the correct depth, the bow of the boat could drop when powering off incorrectly, possibly damaging the boat.

NOTE: Before operating your Moomba, refer to the Daily Check List and the Boatman's Check List.

To unload the boat use the following procedure as a guide:

1. Make sure that all drain plugs are securely in place.
2. Unplug light cord before backing into the water.
3. With Bow Eye Hook fastened, back the trailer until the water level is approximately one inch below the top of the trailer fenders.
4. Follow the cold start procedure recommended in this manual.
5. After starting engine, unlatch Bow Eye Hook to ensure the boat will release from the trailer.
6. With engine idling, center the steering wheel, engage the transmission into reverse (pull back on lever,) then ease back on the throttle.

NOTE: Because your Moomba is a true inboard, when backing the stern will have a tendency to drift left or right depending on propeller rotation. This condition will self-correct as the rudder reaches control speed.

NOTE: Ramp slopes vary, so actual level of water on trailer may be different.

CAUTION

Make sure that the engine water intake is fully submerged.

1. Follow the cold start procedure recommended in this manual.
2. After starting engine, unlatch Bow Eye Hook to ensure the boat will release from the trailer.
3. With engine idling, center the steering wheel, engage the transmission into reverse (pull back on lever,) then ease back on the throttle.

NOTE: Because your Moomba is a true inboard, when backing the stern will have a tendency to drift right due to propeller rotation.

LOADING PROCEDURE



To re-trailer the boat, position the trailer in the water with approximately 1 inch of the top of the fender showing as in step 3. UNLOADING.

Idle/coast the boat onto the trailer using as little power as possible keeping it centered between the guide poles.

NOTE: DO NOT Power onto the trailer during rough conditions.

When correctly positioned on the trailer turn off ignition. Use the Hook and Trailer Winch to pull the boat up to the Roller Stop.

CAUTION

The trailer must be positioned for the correct water depth for loading or you may damage the boat. Varying ramp angles require different procedures. In general, the steeper the ramp, the more shallow the trailer should be positioned in the water. Your local dealer can help you understand this, should you require additional assistance.

TRAILER ALIGNMENT



When pulling the boat onto the trailer, be sure that it is centered on the trailer.

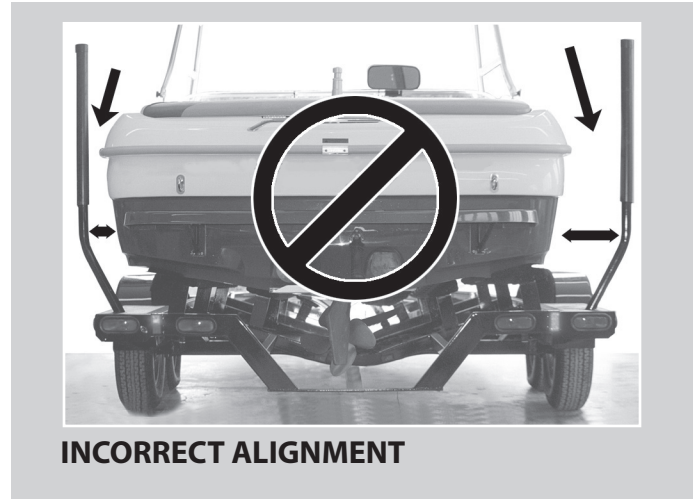

The distance between the boat and the wheel runner board should be about equal on both sides.

SKIER'S CHOICE 2018 MOOMBA® BOAT LIMITED WARRANTY

Skier's Choice, Inc. ("Skier's Choice") provides the following manufacturer's limited warranty, subject to the remedies, conditions, exclusions, and limitations set forth below, on all Moomba® brand water sports boats sold as new by our authorized dealers. ("Covered Boats"). Indmar Marine Engines provides a manufacturer's limited warranty (the "Engine Warranty") for the engine of each Covered Boat. Boatmate Trailers provides a manufacturer's limited warranty (the "Trailer Warranty") for the trailer sold by our authorized dealers with each Covered Boat. For specific information on the Engine Warranty and the Trailer Warranty, please refer to the individual Indmar and Boatmate limited warranty policies. Exclusions and limitations apply.

DISCLAIMER AND LIMITATION OF IMPLIED WARRANTIES

ALL OTHER WARRANTIES AND REPRESENTATIONS, EXPRESS OR IMPLIED, ARE SUPERSEDED BY THIS LIMITED WARRANTY. AND, SKIER'S CHOICE DISCLAIMS, AND THE OWNER HEREBY EXPRESSLY WAIVES, TO THE MAXIMUM EXTENT ALLOWED BY APPLICABLE LAW, ANY AND ALL OTHER WARRANTIES, CONDITIONS OR REPRESENTATIONS OF ANY KIND, INCLUDING, BUT NOT LIMITED TO, IMPLIED WARRANTIES OF MERCHANTABILITY AND FITNESS FOR A PARTICULAR PURPOSE, OTHER THAN THOSE WARRANTIES WHICH ARE IMPLIED BY, AND CANNOT BE EXCLUDED, RESTRICTED, OR MODIFIED UNDER APPLICABLE LAW. THE TERM OF ANY IMPLIED WARRANTIES THAT CANNOT BE DISCLAIMED UNDER APPLICABLE LAW, INCLUDING, BUT NOT LIMITED TO, IMPLIED WARRANTIES OF MERCHANTABILITY AND FITNESS FOR A PARTICULAR PURPOSE, SHALL BE LIMITED TO THE DURATION OF THE EXPRESS WARRANTY PERIODS STATED HEREIN. SOME STATES DO NOT ALLOW THE EXCLUSION OF IMPLIED WARRANTIES AND/OR DO NOT ALLOW LIMITATIONS ON THE AMOUNT OF TIME AN IMPLIED WARRANTY LASTS, SO THE ABOVE LIMITATIONS MAY NOT APPLY TO YOU. HOWEVER, IN THE EVENT THAT APPLICABLE STATE OR COUNTRY LAW DOES NOT ALLOW EXCLUSION OF IMPLIED WARRANTIES BUT SETS FORTH THAT IMPLIED WARRANTIES MAY BE LIMITED IN DURATION, THIS LIMITED WARRANTY LIMITS THE DURATION OF IMPLIED WARRANTIES TO THE TIME PERIOD PROVIDED IN THIS LIMITED WARRANTY OR APPLICABLE STATE LAW, WHICHEVER IS SHORTER. THIS LIMITED WARRANTY GIVES YOU SPECIFIC LEGAL RIGHTS. YOU MAY HAVE OTHER RIGHTS WHICH VARY FROM STATE TO STATE OR COUNTRY TO COUNTRY. THIS LIMITED WARRANTY DOES NOT AFFECT THE RIGHTS YOU MAY HAVE UNDER LAWS IN OTHER COUNTRIES.

LIMITED WARRANTY. Skier's Choice warrants to the original retail purchaser (the "First Owner") that the components and parts manufactured by Skier's Choice described below (the "Covered Components") of each Covered Boat are free from any defects in material and workmanship, under normal use and when operated and maintained according to Skier's Choice's instructions for the applicable Warranty Periods (defined below). The Skier's Choice warranty does not cover the engine and trailer sold with a Covered Boat, which are separately warranted under the Engine Warranty and the Trailer Warranty, respectively.

LIMITED FIVE-YEAR WARRANTY PERIOD ON COVERED COMPONENTS. This Limited Warranty applies to Covered Components other than the deck, hull, floor, and stringers for a period of five years (the “Five-Year Warranty Period”) from the original date of purchase by the First Owner (the “Original Purchase Date”), except as outlined herein. During the first two years of ownership Skier’s Choice will provide both parts and labor for Covered Components; during years three (3) through five (5) of ownership Skier’s Choice will provide replacement parts only for Covered Components and labor will be the responsibility of the Owner. This Five-Year Warranty Period does not apply to the audio, instrumentation, and electronic systems; Skier’s Choice will provide both parts and labor for these systems for the first two years of ownership. Exclusions apply.

LIMITED LIFETIME PERIOD STRUCTURAL WARRANTY. This Limited Warranty applies to the deck, hull, floor (excluding carpet), and stringers for as long as the First Owner owns the Covered Boat (the “Lifetime Warranty Period”). Exclusions apply.

LIMITED ONE-YEAR WARRANTY PERIOD ON GEL COAT. This Limited Warranty applies to the gel coat for a period of one year (the “One-Year Warranty Period”) from the original date of purchase by the First Owner (the “Original Purchase Date”). The gel coat warranty is not transferable. Exclusions apply.

WARRANTY TRANSFER.

The First Owner of a Covered Boat may assign and transfer (“Warranty Transfer”) the Covered Components Warranty and the Structural Warranty to the second owner (the “Second Owner”) subject to the following conditions:

- 1) the sale or conveyance by the First Owner occurs within five years after the Original Purchase Date;
- 2) an Authorized Moomba® Dealer inspects the Covered Boat within 14 days after the sale or conveyance by the First Owner to the Second Owner; and

3) the Warranty Transfer fee in effect at the time of the sale or conveyance from the First Owner to the Second Owner is paid to the inspecting Authorized Moomba® Dealer. Skier’s Choice may refuse to accept the Warranty Transfer if the dealer inspection reveals that the Covered Boat has been damaged or abused. If the sale or conveyance by the First Owner occurs more than five years after the Original Purchase Date, then this Limited Warranty (the Structural Warranty) shall be void as of the date of transfer and shall not be transferable to the Second Owner. Only one Warranty Transfer within the applicable five year time period will be accepted by Skier’s Choice, and any Structural Warranty transferred to a Second Owner will terminate ten years from the Original Purchase Date. This Limited Warranty immediately terminates without notice if and when the Second Owner sells or transfers the Covered Boat to a subsequent owner, and this Limited Warranty shall then be null and void. Warranty transfer for engine must be completed through Indmar. Warranty transfer of the trailer must be completed through Boatmate Trailer.

If the Covered Boat is: 1) repossessed from the First Owner or the Second Owner; 2) purchased at auction (bank auction, online auction, auction house, etc.); 3) sold to or purchased from a salvage yard; or 4) sold to or purchased from an insurance company that obtained the Covered Boat as a result of an insurance claim then the Limited Warranty terminates and is null and void.

EXCLUSIONS

Skier's Choice boats are manufactured from high-quality materials and components by skilled team members. Conditions outside of Skier's Choice control, however, require limitations and exclusions from coverage under this Limited Warranty. Therefore, claims arising from or relating to the following are NOT covered by this Limited Warranty and Skier's Choice disclaims any liability or obligation to the First Owner or the Second Owner, and any other person or party, with respect to the following:

1. Defects in or damage to a Covered Boat caused by the engine, trailer, or any components or parts (including, but not limited to, the bilge pump) not manufactured by Skier's Choice. (Note: These excluded items may be covered by the Engine Warranty, the Trailer Warranty, or separate warranty from the part or component manufacturer);
2. Defects in a Covered Boat that has been sold or transferred by the First Owner and the Warranty Transfer conditions have not been timely satisfied;
3. Hardware or other components fastened or adhered to the hull, deck, floor, or stringers of the Covered Boat;
4. Normal maintenance and upkeep relating to the Covered Boat or any part thereof, including, but not limited to, alignment, adjustments, connectors, tune-ups and wear items, such as, shaft packing, belts, hoses, filters, seals, gaskets, and strut bushing;
5. Damage to or malfunction of a Covered Boat, or any component thereof, resulting from lack of maintenance, improper maintenance, impact, misuse, negligence, collision, allision, accident, or delay in repair;
6. Damage caused by fire, theft, freezing, vandalism, explosion, lightning, wind, hail storms, flooding, natural disasters, or Acts of God;
7. Equipment installed, repaired or replaced by anyone other than an Authorized Moomba® Dealer or the Skier's Choice factory or factory representative;
8. Damage caused by any dealer-installed or Owner-installed options or accessories;
9. Damage caused by use of the Covered Boat from: racing, speed or commercial competitions; performance demonstrations; ski schools; rental, charter, or other commercial uses; or military or industrial purposes;
10. Damage caused by improper alteration or modification to the Covered Boat or any of its component parts or accessories, including any damage caused by alteration, modification, repair, or replacement so as to increase the cubic inch capacity or horsepower output of the engine and Covered Boat from what was originally manufactured;
11. Damage caused by use of improper or contaminated materials or substances, including, but not limited to fuel, lubricants, or coolants;
12. Damage caused by failure to timely comply with any recall or request for repair, including the failure to observe any instructions regarding use or maintenance pending completion of recall repairs;
13. Damage caused by improper storage or support of the Covered Boat on davits, a hoist or cradling system, or boat lift of any kind;
14. Damage caused by failure to maintain the Covered Boat in accordance with the maintenance provisions in the Owner's Manual;
15. Speed, range, fuel consumption and other performance characteristics of the Covered Boat because they are estimated and may vary;

16. Damage to or defects in paints, varnishes, gel coat surfaces and colors, finish distortions, chrome plated or anodized finishes, floor covers, and any other surface coatings;
17. Gel coat discoloration, blisters, bubbles, or fading, including, but not limited to, those which may result from the Covered Boat being left in the water for long periods of time, or the failure to perform maintenance on the gel coat in a timely and proper manner in accordance with the Owner's Manual;
18. Upholstery cracks, mold or mildew, stains, fading, or tears resulting from use, the failure to perform maintenance on the upholstery in a timely and proper manner in accordance with the Owner's Manual, impact, misuse, negligence, delay in repair, use of improper cleaners or conditioners;
19. Changes, revisions, or improvements made to the design, manufacture, options, accessories, or warranties of Skier's Choice boats from previous boats, including the Covered Boat;
20. Any Covered Boat purchased from a dealer in another country, where the primary use of the boat will require the boat to cross an international border, except to the extent otherwise expressly provided in a separate written agreement between the First Owner and Skier's Choice.
21. Corrosion due to containments, environmental, or otherwise.

SOLE REMEDY

THE SOLE AND EXCLUSIVE REMEDY OF THE FIRST OWNER AND, IF APPLICABLE, THE SECOND OWNER, IS THE REPAIR OR REPLACEMENT, AT THE OPTION OF SKIER'S CHOICE, OF THE DEFECTIVE COVERED COMPONENT PARTS OF A COVERED BOAT AS PROVIDED HEREIN. IN NO EVENT, TO THE MAXIMUM EXTENT ALLOWED BY APPLICABLE LAW, SHALL SKIER'S CHOICE BE LIABLE FOR ANY INCIDENTAL, CONSEQUENTIAL, SPECIAL, INDIRECT, PUNITIVE OR EXEMPLARY DAMAGES OR LOST PROFITS ARISING OUT OF THE USE OR INABILITY TO USE THE COVERED BOAT OR ANY COVERED COMPONENT PART THEREOF, OR FOR ANY BREACH OF THIS LIMITED WARRANTY OR OTHERWISE. SOME STATES AND COUNTRIES, HOWEVER, DO NOT ALLOW THE EXCLUSION OR LIMITATION OF INCIDENTAL OR CONSEQUENTIAL DAMAGES, SO THE ABOVE LIMITATIONS OR EXCLUSIONS MAY NOT APPLY TO YOU.

Any Covered Component returned during the applicable Warranty Period to any Authorized Moomba® Dealer will be repaired or replaced at the sole option of Skier's Choice's provided that the following conditions apply:

1. Only the Covered Components that are declared defective upon examination by or for Skier's Choice will be repaired or replaced under this Limited Warranty;
2. Transportation of the Covered Boat or Covered Components to the Authorized Moomba® Dealer, or, if necessary, the Skier's Choice factory, must be pre-paid by the Covered Boat Owner;
3. Notice of any claim or defect under this Limited Warranty must be provided to an Authorized Moomba® Dealer no later than sixty (60) days after the Owner becomes aware of the defect;

4. The Covered Boat was purchased at a dealership authorized by Skier's Choice to distribute the boat model in the country in which the sale to the First Owner occurred.

Notification of Claim. Notification of a claim or defect in a Covered Boat must be made during the applicable Warranty Period directly to an Authorized Moomba® Dealer within 60 days after the Owner becomes aware of the defect. Information needed for processing a claim includes 1) name and address of the Owner; 2) serial number of the boat; 3) Original Purchase Date; 4) detailed explanation of the defect; and (5) estimated repair cost. Repair or replacement cannot be made until all of this information is received by an Authorized Moomba® Dealer. If a Covered Boat has been at an Authorized Moomba® Dealer for 15 days, or any warranty claim was not remedied in one repair attempt, an Owner must notify Skier's Choice directly. An Owner is responsible for providing Skier's Choice written notice of any warranty claims pending or discovered prior to the expiration of the Warranty Period.

Repair and Replacement. In case of a defective Covered Component for which a claim has been properly made during the applicable Warranty Period, Skier's Choice will repair or replace, at its sole discretion, the Covered Component within a reasonable time period of receipt, unless otherwise required by law, by an Authorized Moomba® Dealer, or, if necessary, the Skier's Choice factory. Covered Components replaced or repaired pursuant to this Limited Warranty shall not extend the original Warranty Period, unless otherwise required by law. The repair or replacement of Covered Components will be made by Skier's Choice without charge to the Owner for parts or labor. The replacement or repair of the defective part or component as stated in this Limited Warranty shall be the sole and exclusive remedy of the Owner and the sole liability of Skier's Choice under this Limited Warranty and any implied warranties. Acceptance of any returned component by an Authorized Moomba® Dealer or Skier's Choice shall not be deemed an admission that the component is defective.

SKIER'S CHOICE'S LIABILITY SHALL BE LIMITED SOLELY AND EXCLUSIVELY TO THE REPAIR OR REPLACEMENT OF THE COVERED BOAT OR COVERED COMPONENT FOUND TO BE DEFECTIVE AND REPORTED DURING THE APPLICABLE WARRANTY PERIOD. IN NO EVENT, SHALL SKIER'S CHOICE'S ULTIMATE LIABILITY EXCEED THE FAIR MARKET VALUE OF THE COVERED COMPONENT OR THE COVERED BOAT FOUND TO BE DEFECTIVE AND REPORTED DURING THE APPLICABLE WARRANTY PERIOD. SOME STATES AND COUNTRIES, HOWEVER, DO NOT ALLOW THE EXCLUSION OR LIMITATION OF LIABILITY, SO THE ABOVE LIMITATIONS MAY NOT APPLY TO YOU.

No third party beneficiaries. This Limited Warranty does not create any right or benefit for any third party and is for the sole benefit of the First Owner and, if applicable after a valid Warranty Transfer, the Second Owner.

OTHER LIMITATIONS

THE DEALER IS NOT THE AGENT OF SKIER'S CHOICE AND SKIER'S CHOICE DOES NOT AUTHORIZE THE DEALER, OR ANY OTHER PERSON, TO ASSUME ON BEHALF OF SKIER'S CHOICE ANY LIABILITY, OBLIGATION OR EXPENSE INCURRED IN THE COURSE OF REPAIRING ITS PRODUCTS OTHER THAN THOSE EXPRESSLY AUTHORIZED IN THIS LIMITED WARRANTY. THE DEALER MAY NOT EXTEND OR IN ANY WAY CHANGE OR AMEND THIS LIMITED WARRANTY, NOR CAN THE DEALER MAKE OR ALTER THIS LIMITED WARRANTY OR MAKE ANY REPRESENTATIONS ON BEHALF OF SKIER'S CHOICE.

No advice or communication of any nature by Skier's Choice or its representatives shall modify or extend the terms or scope of this Limited Warranty, nor can a Skier's Choice representative make any representation on behalf of Skier's Choice that in anyway modifies the terms or scope of this warranty, except as authorized in writing by the Chief Executive Officer ("CEO") or President of Skier's Choice.

ANY ACTION FOR BREACH OF WARRANTY AGAINST SKIER'S CHOICE SHALL BE BARRED UNLESS IT IS COMMENCED WITHIN ONE YEAR FROM THE DATE OF ACCRUAL OF SUCH CAUSE OF ACTION. SOME STATES OR COUNTRIES MAY NOT ALLOW THE APPLICABLE STATUTE OF LIMITATIONS FOR BREACH OF WARRANTY TO BE REDUCED, SO THIS PROVISION MAY NOT APPLY TO YOU.

This Limited Warranty shall be modified in its application and enforcement to the extent restricted, prohibited, or modified by local law to conform to applicable law.

The invalidity or unenforceability of any one or more of the provisions of this Limited Warranty herein shall not affect the validity and enforceability of other provisions.

AUSTRALIAN CONSUMERS ONLY

Warranty claims under this Limited Warranty may be sent to Ride Australia Pty Ltd., 245 Princes Highway PO Box 1454 Nowra, NSW, Australia 2541 (Tel: +61 2 4422 4477) service@rideaustralia.com.au.

The benefits to the consumer given by this Limited Warranty are in addition to other rights and remedies of the consumer under a law in relation to the goods to which the warranty relates.

This Limited Warranty does not cover any expenses that you may incur claiming the warranty.

Our goods come with guarantees that cannot be excluded under the Australian Consumer Law. You are entitled to a replacement or refund for a major failure and compensation for any other reasonably foreseeable loss or damage. You are also entitled to have the goods repaired or replaced if the goods fail to be of acceptable quality and the failure does not amount to a major failure.

CALIFORNIA EVAPORATIVE EMISSIONS CONTROL SYSTEM WARRANTY STATEMENT

YOUR WARRANTY RIGHTS AND OBLIGATIONS

The California Air Resources Board and Skier's Choice, Inc., is pleased to explain the evaporative emissions control system's warranty on your MY2018 Moomba. In California, new SIMW must be designed, built, and equipped to meet the State's stringent anti-smog standards. Skier's Choice, Inc. must warrant the evaporative emissions control system on your Moomba for the period listed below, provided there has been no abuse, neglect or improper maintenance of your SIMW.

Your evaporative emissions control system may include parts such as: canisters, carburetors, clamps, connectors, filters, fuel caps, fuel lines, fuel tanks, valves, vapor hoses, and other associated evaporative emissions control system components.

MANUFACTURER'S WARRANTY COVERAGE:

This evaporative emissions control system is warranted for two years. If any evaporative emission-related part on your SIMW is defective, the part will be repaired or replaced by Skier's Choice, Inc..

OWNER'S WARRANTY RESPONSIBILITIES:

As the Moomba owner, you are responsible for performance of the required maintenance listed in your owner's manual. Skier's Choice, Inc. recommends that you retain all receipts covering maintenance on your Moomba, but Skier's Choice, Inc. cannot deny warranty solely for the lack of receipts.

As the Moomba owner, you should however be aware that the Skier's Choice, Inc. may deny you warranty coverage if your Moomba or a part has failed due to abuse, neglect, improper maintenance or unapproved modifications.

You are responsible for presenting your Moomba to a Skier's Choice, Inc. distribution center or service center as soon as the problem exists. The warranty repairs should be completed in a reasonable amount of time, not to exceed 30 calendar days. If you have a question regarding your warranty coverage, you should contact Skier's Choice, Inc. Customer Service Department at 1-800-970-3744.

NOTE: Authority cited: Sections 39600, 39601, 43212 and 43013 Health and Safety Code. Reference: Section 43013 Health and Safety Code. Skier's Choice may be contacted at: Skier's Choice, Inc. 1717 Henry G. Lane Street Maryville, TN 37801 Toll Free Tel: 1-800-970-3744 Local Tel: (865) 983-9924 Fax: (865) 983-9950 International Tel: +1 (865) 983-9924 Email: moombainfo@skierschoice.com

Your evaporative emissions control system includes, fuel cap, fuel lid, fuel vent, fuel carbon canister, inlet control valve, fuel vent hose, fuel fill hose, high pressure fuel line, fuel tank, fuel tank bracket, fuel hose lock clip, fuel fill "T" fitting, inlet control valve shield, fuel vent hose clamps, and other associated evaporative emissions control system components.

Skier's Choice may be contacted at:

Skier's Choice, Inc.
1717 Henry G. Lane Street Maryville, TN 37801
Toll Free Tel: 1-800-970-3744
Local Tel: (865) 983-9924 Fax: (865) 983-9950
International Tel: +1 (865) 983-9924
Email: moombainfo@skierschoice.com

OWNER'S RESPONSIBILITY

1. Before operating your Moomba, it is necessary to read and fully understand this Owner's Manual and all other information delivered with the boat.
2. It is the owner's responsibility to take the boat to an authorized Moomba dealer to obtain warranty service.
3. It is the owner's responsibility to properly operate and maintain the boat in accordance with this manual and all other information delivered with the boat.
4. The owner should keep maintenance records should it be necessary to show that required maintenance has been performed on the boat.

DEALER'S RESPONSIBILITY

1. The Dealer should provide the buyer with an adequate orientation in the general operation of the boat and review all systems and accessories included with the boat.
2. The Dealer should deliver a complete owner's manual packet with the boat consisting of Owner's Manual, Registration, Engine Manual, Stereo Manual, Moomba Warranty and all warranties for separately warranted items aboard the boat.
3. The Dealer should review all warranty information with the buyer and assist in filling out warranty cards if necessary.
4. The Dealer should ensure that any information or obligation from either Skier's Choice, Inc. or from the dealership is clearly understood by the buyer.
5. The Dealer should instruct the buyer in obtaining local service and out-of-area service for a Moomba boat.

CUSTOMER ASSISTANCE

The staff at Skier's Choice, Inc. is concerned with your complete satisfaction. This includes the prompt resolution of any problems that may arise during the warranty period. Normally, problems encountered may be efficiently and effectively resolved by your Moomba Dealer. However, if a problem cannot be handled by the Dealer or if a solution is not satisfactory to you as an Owner, please follow these steps to get the matter resolved:

STEP ONE

Discuss the problem with a member of your Moomba Dealer's management staff. It is most likely that the problem will be resolved at this level.

STEP TWO

If the Dealer management does not resolve the problem to your satisfaction, please have the problem and all action taken, documented by the Dealer, then contact the factory Customer Service Representative at Skier's Choice, Inc.

Skier's Choice, Inc.
1717 Henry G. Lane Street
Maryville, TN 37801
Toll Free: (800) 970-3744
Tel: (865) 983-9924
Fax: (865) 983-9950

Describe the original problem in detail to the Customer Service Representative. Be prepared to furnish appropriate documentation and the reasons why service by the Dealer was unsatisfactory. If further action is required to resolve the problem, the Customer Service Representative will dictate the appropriate action.

STEP THREE

Finally, if after following these steps and providing documentation and after obtaining necessary authorization from the Customer Service Representative to take additional action, the problem is still not resolved to your satisfaction, the President of Skier's Choice, Inc. will personally review the problem and make a determination concerning a resolution.

WATERSPORTS SAFETY CODE

Before you get in the water: Skiing or riding instruction is recommended before use. Instruction will teach general safety guidelines and proper skiing or riding techniques, which may reduce your risk of injury. For more information on skiing or riding schools, contact your dealer, Association, or local ski club.

- Know the federal, state and local laws that apply to your area.
- If you are not familiar with a waterway, ask someone who is, to tell you about any hidden dangers or things to avoid
- Whether you plan to be in a watercraft, or skiing/riding behind one it is important you are wearing a properly fitted life jacket (PFD) approved by your country's agency, USCG Type III, ISO, etc.
- Inspect all equipment prior to each use, check bindings, fins, tube, attachment, tow rope and flotation device. Do not use if damaged.

Watercraft Safety: A knowledgeable and responsible driver is the most important safety device on any watercraft.

- Never operate a watercraft, ski or ride under the influence of alcohol or drugs.
- Only use water ballast and people for additional weight.
- Never exceed the passenger or weight limitations of the watercraft.
- Never allow passengers to hang outside the watercraft or towed device or sit on the gunwales or anywhere outside of the normal seating area.
- Never allow water to overflow the bow or gunwales of the watercraft.
- Uneven weight distribution or additional weight may; affect the handling of the watercraft.

Carbon Monoxide: The exhaust from the engine on a watercraft contains Carbon Monoxide (CO) which is a colorless, odorless and poisonous gas. Excessive exposure to CO can cause severe injury or death.

Follow this advice to avoid injury:

- Never "Platform Drag" by holding onto the boarding platform or be dragged directly behind the watercraft. This is where CO will be.
- Do not sit on the watercraft transom or boarding platform while the engine is running.

- Make sure the engine is properly tuned and running well. An improperly tuned engine produces excessive exhaust and CO.
- If you smell engine exhaust, do not stay in that position.
- Go to the United States Coast Guard's website: www.uscgboating.org for more information on how to help protect yourself and others from the dangers of CO.

Tow Ropes: Tow ropes come in different lengths and strengths for different activities. Make sure any rope you are using is suited for skiing or riding and that it is in good condition.

- Never use a rope that is frayed, knotted, unraveling or discolored from use or being left in the sun. If a rope breaks while in use, it can recoil at the skier/rider being towed or into the watercraft where it might strike passengers. Replace tow ropes with any sign of damage.
- Never use a tow rope with elastic or bungee material to pull skiers or riders.
- Rope should be attached to the watercraft in an approved fashion with hardware designed for towing. Refer to your watercraft manual for instructions on proper tow rope attachment.
- Always keep people and tow ropes away from the propeller, even when idling.
- If a tow rope should become entangled in a propeller, shut off the engine, remove the key and put it in your pocket before retrieving the rope.

Preparing to ski or ride: Always have a person other than the driver as an observer to look out for the skier/rider.

- BE sure the driver is aware of the experience and ability level of the skier/rider.
- The driver, observer and skier/rider need to agree on hand signals before skiing or riding. Signals should include READY, STOP, SPEED UP, and SLOW DOWN.
- Start the engine only after making sure that no one in the water is near the propeller.
- **Turn the engine off when people are getting into or out of the watercraft, or in the water near the watercraft.**
- Always make sure the tow rope is not wrapped around anyone's hands, arms, legs, or other parts of the body.
- Start the watercraft and move slowly to remove slack until the tow rope is tight.
- When the skier/rider signals READY and there is no traffic ahead, take off in a straight line. Adjust the speed according to the signals given by the skier/rider.

Skiing or Riding: The watercraft and skier/rider should always maintain a sufficient distance from obstacles so a skier/rider falling or coasting and/or watercraft will not encounter any obstacle.

- Do not use in shallow water or near shore, docks, pilings, swimmers, other watercraft, or any other obstacles.
- Use only on the water.
- Never attempt land or dock starts. This will increase your risk of injury or death.
- Always wear a properly fitted U.S. Coast Guard Type III (PFD) or ISO approved Life Jacket.
- The faster you ski or ride, the greater your risk of injury.
- Never make sharp turns that may cause a slingshot effect on the skier/rider's speed.
- Skier/Rider should be towed at an appropriate speed for their ability level.

Fallen skier or rider: Falling and injuries are common in skiing or riding.

- Circle a fallen skier/rider slowly to return the tow rope handle or pick up the fallen skier/rider.
- Put the watercraft in neutral when near a fallen skier/rider.
- Always keep the fallen skier/rider in view and on the driver's side of the watercraft.
- Display a red or orange skier-down flag to alert other vessels that a skier/rider is down.

The Warnings and practices in the Watersports Safety Code represent common risks encountered by users. The code does not cover all instances of risk or danger. Please use common sense and good judgement.

WATERSPORTS RESPONSIBILITY CODE

Be aware that there are elements of risk in boating, skiing, and riding that common sense and personal awareness can help reduce. Know your ability level and stay within it.

To increase your enjoyment of the sport follow the “Watersports Responsibility Code”.

It is your responsibility to:

- Familiarize yourself with all applicable laws, the risks inherent in the sport, and the proper use of equipment.
- Know the waterways where you will be skiing or riding. Do not ski or ride in shallow water, near shore, docks, pilings, swimmers, or other watercraft.
- Always have a person other than the boat driver as an observer and agree on hand signals before starting.
- Always wear a U.S. Coast Guard type III (PFD) vest.
- Read your owner’s manual and inspect your equipment prior to use.
- Ski or ride within your limits. Always ski or ride in control and at speeds appropriate for you ability.
- Always turn ignition off when anyone is near watercraft power drive unit.
- Carbon Monoxide (CO) poisoning from engine exhaust may cause injury or death. Never “Platform Drag” or touch a swim platform while the engine is running.
- Do not operate watercraft, ski or ride under the influence of alcohol or drugs.
- Water Sports Industry Association



SKIER'S CHOICE, INC

Corporate Headquarters

1717 Henry G. Lane Street, Maryville, Tennessee 37801

Tel: 865-983-9924 - Fax: 865-983-9950

Web: www.supraboats.com

Moomba inboard watersports are manufactured by Skier's Choice, Inc. in Maryville, Tennessee and distributed throughout the United States and the world.

Be sure to read and understand all aspects of Boating Safety and Operation before using your boat.

If you have any questions, your dealer can provide the information you need to have a safe and pleasurable boating experience.

Skier's Choice, Inc. reserves the right to change product specifications at any time without incurring obligation.

