



**Outback**



**Outback V**



**Mobius LSV**



**Mobius XLV**



**Gravity Edition**

# 2011 Owner's Manual

## **MOOMBA**

TOURNAMENT INBOARD BOATS

### **Boat Information**

Hull Identification Number: \_\_\_\_\_

Date of Purchase: \_\_\_\_\_

Dealership: \_\_\_\_\_

Dealer's Phone Number: \_\_\_\_\_

Registration Number: \_\_\_\_\_

Engine Serial Number: \_\_\_\_\_

Trailer Serial Number: \_\_\_\_\_

### **Trademarks**

Moomba, the Moomba Logo, Outback, Outback V, Mobius LSV and Mobius XLV are registered trademarks of Skier's Choice, Inc. All other product names are copyright and registered trademarks/trade names of their respective owners.

Skier's Choice, Inc. reserves the right to change product specifications at any time without incurring obligation.

© 2011 Skier's Choice, Inc.



1717 Henry G. Lane Street  
Maryville, Tennessee 37801  
Telephone: 865-983-9924 Fax: 865-983-9950  
Web: [www.moomba.com](http://www.moomba.com)



## **INTRODUCTION**

Moomba inboard ski and wakeboard boats are manufactured by Skier's Choice, Inc. in Maryville, Tennessee and distributed throughout the United States and the world.

This manual provides an overview for operating your Moomba boat. It should be considered a permanent part of your Moomba boat and contains important information on Safety, Boating Rules, Proper Operation and Maintenance of your boat. Should the boat be sold, this manual will provide the same important information to the next owner.

Be sure to read and understand all aspects of Boating Safety and Operation before using your boat. If you have any questions, your dealer can provide the information you need to have a safe and pleasurable boating experience.

All information, illustrations and specifications in this manual are based on the latest product information available at the time of printing. Moomba may discontinue models and equipment or change specifications and designs without any notice and without incurring obligation.

This manual contains information about several Moomba models. Some information may not apply to your boat since standards and optional equipment may vary from model to model.

As you read through this manual, you will find **CAUTION**, **WARNING** and **DANGER** symbols which require special attention. Please read them carefully! They may tell you how to avoid problems and/or endangering yourself, your passengers, and other boaters.



### **PLEASE REVIEW ALL SAFETY INFORMATION.**

#### **SPECIAL ATTENTION SYMBOLS**



A maintenance schedule and accessory information are included to assure trouble-free operation of your boat. Should service problems arise, remember that your Moomba dealer knows your boat best and is interested in your total satisfaction.

Thank you for purchasing a Moomba boat. We hope your ownership results in an enjoyable and rewarding boating experience.

**Be safe and enjoy the fun!**

**DAILY CHECKLIST**

- Drain Plugs (Securely in place?)
- Life-Saving Devices (One for every person on board?)
- Steering System (Working smoothly and properly?)
- Fuel System (Adequate fuel? Leaks? Fumes?)
- Battery (Fully charged? Cable terminals clean and tight?)
- Engine (In neutral?)
- Capacity Plate (Are you overloaded or overpowered?)
- Weather Conditions (Is it safe to go out?)
- Electrical Equipment (Lights, horn, pump, etc.?)
- Emergency Gear (Fire extinguisher, bailer, paddle, anchor & line, signaling device, tool kit, etc.?)
- Bilge Pump (Working properly?)

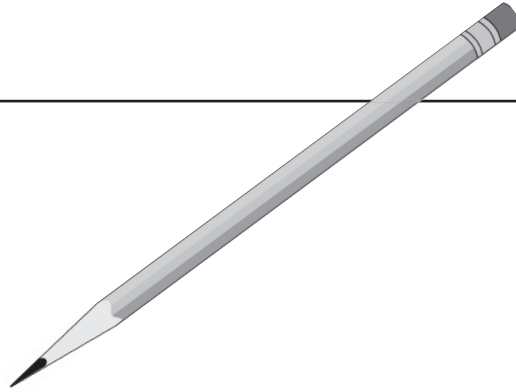

**NOTE:** Bilge pump should be checked prior to each use to ensure proper operation.

**Check BEFORE running your boat (where applicable).**

- Engine Oil Level
- Transmission Lubricant Level
- Engine Drain Plug, Transom Drain Plug and Center Drain Plug
- Leakage (Fuel, water lines and connections)

**CAUTION** DO NOT operate engine without cooling water flowing through water pump, or pump will sustain damage and subsequent engine damage may result!

**Check BEFORE running your boat.**

- Oil Pressure: Refer to Engine Owner's Manual.
- Water Temperature: 160 - 180 degrees for raw water systems (water is not recirculated), and 180 - 200 degrees for closed cooling systems (water is recirculated).
- Idle RPM: (650 - 750) in gear.
- Maximum Forward RPM: Refer to Engine Owner's Manual.
- Shifting Linkage (Forward, Neutral & Reverse).

**WARNING** GASOLINE VAPORS CAN EXPLODE. It is very important to check for fuel spillage or leaks prior to each use of your boat.

- Check engine compartment for gasoline vapors.
- Operate blower for four minutes before starting the engine.
- Always operate blower below cruising speed.

**NOTE:** Please refer to your Engine Owner's Manual for maximum RPM and engine break-in procedure.

## IMPORTANT SAFETY INFORMATION!

Your safety, as well as the safety of others with and around you, is a direct result of how you operate and maintain your boat. Read and comprehend this manual. Make sure that you understand all the controls and operating instructions before attempting to operate the boat. Improper operation is extremely dangerous.

The basic safety rules are outlined in this section of the manual. Additional precautions throughout the manual are noted by the following symbols:



This symbol indicates a potentially hazardous circumstance, which, if not avoided, may result in minor or moderate injury. It may also be used to alert against unsafe practices.



This symbol indicates a potentially hazardous situation, which, if not avoided, could result in death or serious injury.



This symbol indicates an imminently hazardous situation, which, if not avoided, will result in **death** or **serious injury**. This is limited to the most extreme situations.

***The precautions listed in this manual and on the boat are not exhaustive. If a procedure, method, tool or part is not specifically recommended by Skier's Choice, you must satisfy yourself that it is safe for you and others, and that the boat will not be damaged or made unsafe as a result of your decision.***

**REMEMBER: ALWAYS USE COMMON SENSE WHEN OPERATING, SERVICING OR REPAIRING THE BOAT!**

In addition to everyday safety, failure to observe safety recommendations may result in severe personal injury or death to you or to others. Use caution and common sense when operating your boat. Don't take unnecessary chances!

Be certain that all boat passengers are aware of this information and conform to boat safety principles.

## SAFE BOATING

Safe boating practices may seem obvious, but people have thought up risky and dangerous activities in boats, with boats, and behind boats. Just because you or your passengers have seen a boating maneuver performed or have seen a particular activity promoted, do not assume there is no risk of injury or death. Before you or your passengers go out in the boat and engage in any water sport activity, give careful consideration to the risks. Plan ahead. Think twice before you try something new behind your boat or with your boat. Know the limits of you, your passengers and your equipment and do not exceed them.

In addition to careful review of this manual, you should be aware as well that there are many sources of information available. Skier's Choice urges you to pursue additional training, such as safety and seamanship courses offered by the U.S. Coast Guard Auxiliary and the U.S. Power Squadron.

Safe boating and safe actions may seem obvious, yet every year US Coast Guard statistics give evidence that many people disregard safe boating practices. Do not take safety for granted. Think twice. We want all our boat owners and their passengers, friends, and families to have a safe and enjoyable experience on the water.

### US COAST GUARD AUXILIARY BOATING SAFETY COURSE

**The purchaser of a new 2011 Moomba boat is entitled to a USCGA Boating Safety Course that Moomba will pay for. Please see the Certificate in your owner's packet or your dealer for more details.**

## SAFETY TRAINING ORGANIZATIONS

The following is a listing of just some of the agencies and organizations that offer safety training or information:

### American Red Cross, National HQ

17th & D Streets NW, Washington, DC 20006  
(202) 639-3686 [www.redcross.org](http://www.redcross.org)

### USA Waterski

799 Overlook Drive, Winter Haven, FL 33884  
(941) 324-4341 [www.usawaterski.org](http://www.usawaterski.org)

### Boat Owners Association of the United States (BOAT/US)

880 South Pickett Street, Alexandria, VA 22304  
(703) 823-9550 [www.boatus.com](http://www.boatus.com)

### National Safe Boating Council

2550 M Street NW, Suite 425, Washington, DC 20037  
(202) 296-4588 [www.safeboatingcouncil.org](http://www.safeboatingcouncil.org)

### U.S. Coast Guard Auxiliary Commandant (G-NAB)

2100 Second Street SW, Washington, DC 20593-0001  
(800) 336-2628 [www.cgaux.org](http://www.cgaux.org)

### U.S. Power Squadron

[www.usps.org](http://www.usps.org)

### On-Line Basic Boating Safety Course

[www.boatsafe.com](http://www.boatsafe.com)

### National Marine Manufacturers Association

200 E. Randolph Dr. Suite 5100, Chicago, IL 60601  
(312) 946-6200 [www.nmma.org](http://www.nmma.org)

Federal law requires certain safety equipment to be on board at all times. In addition, responsible boaters carry other equipment in case of emergency. Check with the local boating authorities for any additional requirements over and above the federal stipulations.

## SAFETY EQUIPMENT

Your Moomba has been equipped at the factory with most of the federally required safety equipment for inland waters (Class 1, 16'-to-26').

### This equipment includes:

- UL-approved Marine Fire Extinguisher, Type A-BC (2 lbs.), good for solids, liquids, and electrical fire
- ABYC-approved Marine Mufflers with water injection
- USCG-approved Marine Flame Arrestor
- USCG-approved Engine Box Ventilation with sparkless power blower
- ABYC-approved Electric Horn sound warning device
- USCG-approved inland lighting

Federal law also requires at least one Type I, II or III Personal Flotation Device (PFD) for each person on board or being towed on water skis or other recreational equipment. In addition, one throwable Type IV PFD must also be on board. **As the owner, obtaining the appropriate PFDs is your responsibility.** Your Moomba dealer can and will be happy to assist you.

**NOTE: Requirements for coastal waters and inland waters differ. Check with the local authorities for more information.**

A smart owner will avoid potential problems on an outing by having additional equipment on board. Normally, this equipment is dependent on the body of water and the length of the trip.

We suggest the following—as a minimum. Your Moomba dealer can also assist you with additional recommendations:

- An anchor with at least 75 feet of line
- A manual bailing device for removing water
- A combination oar/boat hook
- A day-and-night visual distress signal
- A first aid kit and manual
- An airway breathing tube
- A waterproof flashlight
- A set of local navigation charts
- Mooring lines and fenders
- Extra engine oil
- A tool kit
- A portable AM/FM radio or weather radio
- VHF handheld marine radio

Boating-related accidents are generally caused by the operator's failure to follow basic safety rules or written precautions. Most accidents can be avoided if the operator is completely familiar with the boat, its operation, and can recognize potentially hazardous situations before an accident occurs.

## GENERAL SAFETY PRECAUTIONS

**Failure to adhere to these precautions may result in severe injury or death to you and/or others.**

### **WARNING**

- Improper operation is extremely dangerous. Operators must read and understand all operating manuals supplied with the boat before operation.
- Remain seated at all times while boat is in motion.
- Never stand or allow passengers to stand while the boat is moving. You or others may be thrown from the boat.
- Children in the bow of the boat should be accompanied by an adult at all times.
- Never operate the boat while under the influence of alcohol or drugs.
- On-board equipment must always conform to the governing federal, state, and local regulations.
- Gasoline vapors can explode. Before starting engine, open engine box, check engine compartment for gasoline vapors, and operate blower for at least four minutes.
- Run blower below cruising speed.
- Leaking fuel is a fire and explosion hazard. Inspect system regularly. Examine fuel tanks for leaks or corrosion at least annually.
- Never override or modify the engine safety shut-off switch or engine neutral starting safety switch in any way.
- Never remove or modify components of the fuel system in any way except for maintenance by qualified personnel. Tampering with fuel components may cause a hazardous condition.
- Never allow any type of spark or open flame on board. It may result in fire or explosion.
- It is the owner's responsibility to check tightness of the Rad-A-Cage Tower bolts BEFORE each use.
- The Rad-A-Cage Tower is designed to pull a single (1) individual. DO NOT climb or sit on the Rad-A-Cage Tower. Rope may loop on inverted tricks. DO NOT sit behind the pulling point of the Rad-A-Cage Tower.

### **DANGER**

- To avoid serious personal injury, DO NOT be on or about the swim platform while engine is running and keep away from rear of boat while engine is running.
- To avoid serious personal injury, DO NOT operate engine while anyone is on or about the swim platform or in the water near the boat.

### **CAUTION**

- The tow bar is not designed for vertical extensions. Any modifications to the tow bar or its mountings may result in damage to the boat and injury to the user.
- Rear storage area is located above the gas tank and is not designed for ballast. Weight limit is 150 lbs. equally distributed.
- The Rad-A-Cage Tower may strike low objects. Check clearance height around docks, shore, overhanging objects, bridges and power lines.
- Do not pull past 45 degrees of the centerline of the boat. Failure to follow this rule could result in the boat capsizing.

### **CAUTION**

- It is the driver's responsibility to ensure all passengers are seated when boat is underway.

### **WARNING**

**Failure to adhere to these warnings may result in severe injury or death to you and/or others.**

- This boat is a high-performance boat and capable of quick and tight turns and changes in direction. It is the driver's responsibility to operate the boat in a manner to ensure the safety of all passengers.

### **WARNING**

**Boaters must continuously be aware of weather conditions.**

- Sudden storms, wind, lightning, etc., can unexpectedly put boaters in grave danger. Always check the local weather report before going boating.

### **WARNING**

**It is the driver's responsibility to determine if weather or other factors have created an unsafe boating environment.**

- The driver is solely responsible for the consequences of their actions.

## SKIING SAFETY

Skiers are obligated to be as aware of the fundamental safety rules as well as the boat operator. If you are new to water skiing, seek certified training before starting. You will find it especially helpful to join a local ski club and USA Waterski when possible.

Always remember that the majority of water skiing injuries are the result of impacts with other objects, so always look where you are going and be aware of what is going on around you.

### WARNING

**Failure to adhere to these warnings may result in severe injury or death to you and/or others.**

- Every skier must always wear a USCG-approved personal flotation device.
- Maintain a distance of at least 100 feet from all other objects, including other boats, piers, rafts, mooring and navigational buoys, pilings, abutments, or any other items.
- Always have an experienced driver and observer in the boat when skiing.
- Never ski in shallow water, close to shore, or in water where you do not know the depth or what is beneath the surface.
- Never put your arm, head, or any other part of your body through the handle-bridle of the ski line nor wrap the line around any part of the body at any time.
- Never ski at night, or directly in front of other boats.
- Never jump from a boat that is moving at any speed, nor enter or exit the water when the engine is running (ON).
- Make sure that everyone knows and uses approved skiing hand signals and common skiing courtesy.

## SKI PYLON EXTENSIONS

The use of a ski pylon extension or extensions in excess of 7-feet vertical is not recommended by Moomba on our products. If you elect to use merchandise such as these, be aware that they could create excessive stress on your boat and subjectively cause damages not covered by the warranty.

## CARBON MONOXIDE (CO) SAFETY

### WARNING

Carbon monoxide is a colorless, odorless and tasteless gas. It is produced by gasoline engines and is a component of exhaust fumes.

Shut off the engine when people are on the swim platform or in the water around the rear of the boat.

Do not do any activities which put people in close proximity of the transom when the engine is running.

**For the most current information on carbon monoxide, you may call, write or visit on-line any of the following:**

#### **United States Coast Guard**

Office of Boating Safety (G-OPB-3)  
2100 Second Street SW, Washington, DC 20593-0001  
1-800-368-5647      [www.uscgboating.org](http://www.uscgboating.org)

#### **NMMA**

#### **National Marine Manufacturers Association**

200 East Randolph Drive, Suite 5100, Chicago, IL 60601-6528  
312-946-6200      [www.nmma.org](http://www.nmma.org)

#### **American Boat & Yacht Council, Inc.**

3069 Solomon's Island Road, Edgewater, MD 21037-1416  
410-956-1050      [www.abycinc.org](http://www.abycinc.org)

## PRODUCT MISUSE

Misuse of the product or use of it in a manner for which it was never intended can create dangerous situations. The driver and passengers are responsible for using the product safely and as intended. The driver must operate the boat in a manner that ensures the safety of all passengers. If you or your passengers are unsure about use of the product, about performing certain boating maneuvers or are unsure about a particular water activity, refer to this manual or contact a knowledgeable source such as your local dealer, Skier's Choice, Inc., the US Coast Guard, or your local boating authority.



## PROPER SEATING

Proper seating is an important element of boating safety. Proper seating consists of sitting with your buttocks in full contact with a seat anytime the boat is underway and using hand holds and grab handles to secure oneself and prevent loss of balance. Do not sit in locations not designed as a seat. For instance, do not sit on seat backs, do not sit on the sides or gunwale of the boat, and do not sit on the sundeck while the boat is in motion. See examples below of proper sitting positions.



The driver must be aware of all passenger's locations and positions, and passengers must stay alert to changes in direction.

***The boat is capable of quick and tight turns. Such maneuvers can cause unseated occupants to be thrown around or out of the boat. Alert passengers before changes in direction.***

## CONTACT INFORMATION

If you have questions regarding the operation of your boat, accessory or options or questions in regard to Boat Safety, contact your dealer or Skier's Choice, Inc. at **865-983-9924**.

## TYPICAL WARNING LABEL LOCATIONS

### — DIRECT DRIVE MODELS

Warning labels are placed on your boat to alert you to potential hazards that may not be obvious. They also tell you how to avoid the hazard. Warning labels should never be removed and, if any label is damaged, it should be replaced as soon as possible.

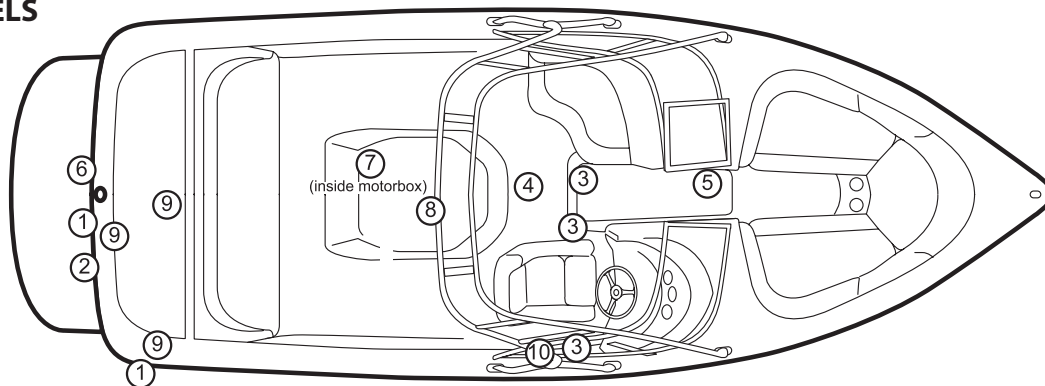

## WARNING PLATES & LABELS

Read and note ALL warning plates and labels from bow to stern that appear on the boat, including these.

If your warning decals should become damaged in any way, please contact your Moomba Dealer or write Skier's Choice, Inc. to request replacement warning decals. The decals will be provided free of charge. Your boat's serial number (located on the transom) must be included for warning decal requests.

(one of two places depending on location of fuel cap)

1  **WARNING**

- AVOID SERIOUS INJURY OR DEATH.
- FIRE, EXPLOSION AND SPLASHING FUEL HAZARD.
- IF TANK IS OVERFILLED, FUEL WILL DISCHARGE OUT THIS PORT.

WLFH0804

(only if boat has tow eye)

2  **WARNING**

- AVOID SERIOUS INJURY OR DEATH.
- TOW EYE SHOULD BE USED ONLY FOR TOWABLE WATER SPORTS DEVICES WITH 1 OR 2 INDIVIDUALS. TOW EYE WEIGHT LIMIT IS 800 LBS.
- DO NOT USE TOW EYE FOR OTHER TOWABLE OBJECTS OR TOWING BOATS.
- DO NOT USE TOW EYE TO LIFT BOAT.

WLTE0803

(one of three places)

3  **DANGER**

- CARBON MONOXIDE AND PROPELLER HAZARD. DO NOT OPERATE ENGINE WHILE ANYONE IS ON OR ABOUT THE SWIM PLATFORM OR IN THE WATER NEAR THE BOAT. OWNERS AND OPERATORS MUST READ AND UNDERSTAND ALL PRODUCT WARNINGS AND MANUALS BEFORE USE.

 **WARNING**

- AVOID SERIOUS INJURY FROM LOSS OF BALANCE AND FALLING OVERBOARD. ALL OCCUPANTS MUST REMAIN SEATED AT ALL TIMES WHILE BOAT IS IN MOTION.
- BOAT IS CAPABLE OF QUICK AND TIGHT TURNS. SUCH MANEUVERS CAN CAUSE UNSEATED OCCUPANTS TO BE THROWN AROUND OR OUT OF THE BOAT. ALERT PASSENGERS BEFORE CHANGES IN DIRECTION. THE DRIVER IS RESPONSIBLE FOR OPERATING BOAT IN A MANNER THAT ENSURES THE SAFETY OF PASSENGERS.
- GASOLINE VAPORS CAN EXPLODE. BEFORE STARTING ENGINE, OPEN ENGINE BOX, CHECK ENGINE COMPARTMENT FOR GASOLINE VAPORS, AND OPERATE BLOWER FOR AT LEAST 4 MINUTES. RUN BLOWER BELOW CRUISING SPEED.

WLDG0804

4  **WARNING**

- AVOID SERIOUS INJURY OR DEATH.
- TOW PYLON SHOULD BE USED ONLY FOR TOWABLE WATER SPORTS DEVICES.
- DO NOT USE TOW PYLON FOR OTHER TOWABLE OBJECTS OR TOWING BOATS.
- TOW PYLON IS NOT DESIGNED FOR VERTICAL EXTENSIONS. ANY MODIFICATIONS TO THE TOW PYLON OR ITS MOUNTINGS MAY RESULT IN DAMAGE TO THE BOAT AND INJURY TO THE USER.
- DO NOT SIT BEHIND THE TOW PYLON WHEN IN USE.

WLSKP0803

5  **WARNING**

- AVOID SERIOUS INJURY OR DEATH FROM LOSS OF BALANCE AND FALLING OVERBOARD.
- CHILDREN SHOULD BE SUPERVISED BY AN ADULT AT ALL TIMES.
- REMAIN PROPERLY SEATED AT ALL TIMES WHILE BOAT IS IN MOTION.
- DO NOT STAND UP OR MOVE ABOUT WHILE THE BOAT IS IN MOTION.

WLOB0804

6  **DANGER**

- AVOID SERIOUS INJURY OR DEATH FROM CARBON MONOXIDE AND PROPELLER HAZARD.
- DO NOT BE ON OR ABOUT THE SWIM PLATFORM WHILE ENGINE IS RUNNING OR BOAT IS IN MOTION.
- KEEP AWAY FROM REAR OF BOAT WHILE ENGINE IS RUNNING.

WLSWP0804

(inside motorbox)

7  **WARNING**

- AVOID SERIOUS INJURY OR DEATH.
- LEAKING FUEL IS A FIRE AND EXPLOSION HAZARD.
- INSPECT SYSTEM REGULARLY. EXAMINE FUEL SYSTEM FOR LEAKS AND CORROSION AT LEAST ANNUALLY.

WLENG0803

(if equipped with tower)

8  **WARNING**

- AVOID SERIOUS INJURY OR DEATH FROM MISUSE OF TOWER.
- THE TOWER IS DESIGNED TO PULL A SINGLE (1) WAKEBOARDER.
- DO NOT CLIMB OR SIT ON THE TOWER.
- DO NOT SIT BEHIND THE PULLING POINT OF THE TOWER TO AVOID CONTACT WITH ROPE.
- THE TOWER MAY STRIKE LOW OBJECTS. CHECK CLEARANCE HEIGHTS DURING OPERATION AND TOWING.

WLTWR0804

(one of three places)

9  **CAUTION**

- REAR STORAGE AREA NOT DESIGNED FOR BALLAST.
- GAS TANK LOCATED UNDER FLOOR OF STORAGE AREA.
- STORAGE AREA WEIGHT CAPACITY IS 150 LBS.

WLRB0804

10  **WARNING**

**LOOSE FITTINGS  
MAY RESULT IN  
TOWER COLLAPSE.**

**CHECK TIGHTNESS  
OF TOWER BOLTS  
AND KNOBS BEFORE  
EACH USE.**

WLRB0804

Skier's Choice, Inc. reserves the right to change warning labels without notification or incurring obligation. For a copy of the most current warning labels, please contact your dealer or Skier's Choice, Inc.

## TYPICAL WARNING LABEL LOCATIONS — V-DRIVE MODELS

Warning labels are placed on your boat to alert you to potential hazards that may not be obvious. They also tell you how to avoid the hazard. Warning labels should never be removed and, if any label is damaged, it should be replaced as soon as possible.

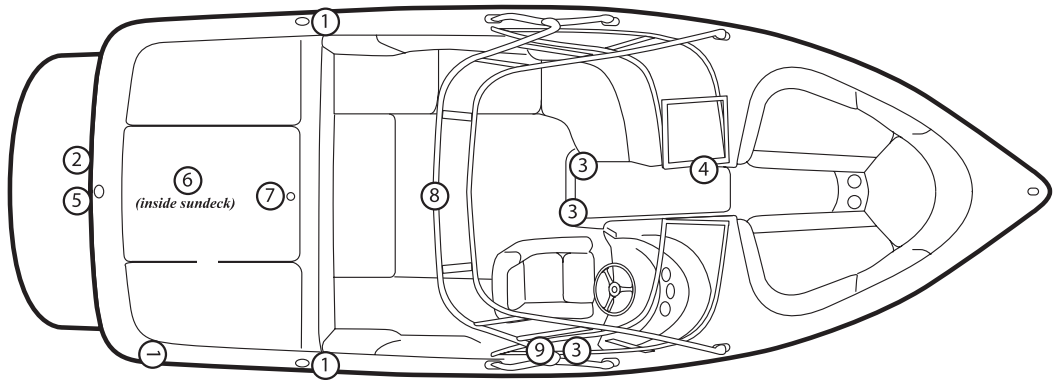

## WARNING PLATES & LABELS

Read and note ALL warning plates and labels from bow to stern that appear on the boat, including these.

If your warning decals should become damaged in any way, please contact your Moomba Dealer or write Skier's Choice, Inc. to request replacement warning decals. The decals will be provided free of charge. Your boat's serial number (located on the transom) must be included for warning decal requests.

*(one of two places depending on location of fuel cap)*

① **WARNING**

- AVOID SERIOUS INJURY OR DEATH.
- FIRE, EXPLOSION AND SPLASHING FUEL HAZARD.
- IF TANK IS OVERFILLED, FUEL WILL DISCHARGE OUT THIS PORT.

WLFH0804

*(only if boat has tow eye)*

② **WARNING**

- AVOID SERIOUS INJURY OR DEATH.
- TOW EYE SHOULD BE USED ONLY FOR TOWABLE WATER SPORTS DEVICES WITH 1 OR 2 INDIVIDUALS. **TOW EYE WEIGHT LIMIT IS 800 LBS.**
- DO NOT USE TOW EYE FOR OTHER TOWABLE OBJECTS OR TOWING BOATS.
- DO NOT USE TOW EYE TO LIFT BOAT.

WLTE0803

*(one of three places)*

③ **DANGER**

- CARBON MONOXIDE AND PROPELLER HAZARD. DO NOT OPERATE ENGINE WHILE ANYONE IS ON OR ABOUT THE SWIM PLATFORM OR IN THE WATER NEAR THE BOAT. OWNERS AND OPERATORS MUST READ AND UNDERSTAND ALL PRODUCT WARNINGS AND MANUALS BEFORE USE.

**WARNING**

- AVOID SERIOUS INJURY FROM LOSS OF BALANCE AND FALLING OVERBOARD. ALL OCCUPANTS MUST REMAIN SEATED AT ALL TIMES WHILE BOAT IS IN MOTION.
- BOAT IS CAPABLE OF QUICK AND TIGHT TURNS. SUCH MANEUVERS CAN CAUSE UNSEATED OCCUPANTS TO BE THROWN AROUND OR OUT OF THE BOAT. ALERT PASSENGERS BEFORE CHANGES IN DIRECTION. THE DRIVER IS RESPONSIBLE FOR OPERATING BOAT IN A MANNER THAT ENSURES THE SAFETY OF PASSENGERS.
- GASOLINE VAPORS CAN EXPLODE. BEFORE STARTING ENGINE, OPEN ENGINE BOX, CHECK ENGINE COMPARTMENT FOR GASOLINE VAPORS, AND OPERATE BLOWER FOR AT LEAST 4 MINUTES. RUN BLOWER BELOW CRUISING SPEED.

WLDG0804

④ **WARNING**

- AVOID SERIOUS INJURY OR DEATH FROM LOSS OF BALANCE AND FALLING OVERBOARD.
- CHILDREN SHOULD BE SUPERVISED BY AN ADULT AT ALL TIMES.
- REMAIN PROPERLY SEATED AT ALL TIMES WHILE BOAT IS IN MOTION.
- DO NOT STAND UP OR MOVE ABOUT WHILE THE BOAT IS IN MOTION.

WLOB0804

⑤ **DANGER**

- AVOID SERIOUS INJURY OR DEATH FROM CARBON MONOXIDE AND PROPELLER HAZARD.
- DO NOT BE ON OR ABOUT THE SWIM PLATFORM WHILE ENGINE IS RUNNING OR BOAT IS IN MOTION.
- KEEP AWAY FROM REAR OF BOAT WHILE ENGINE IS RUNNING.

WLSWP0804

*(inside motorbox)*

⑥ **WARNING**

- AVOID SERIOUS INJURY OR DEATH.
- LEAKING FUEL IS A FIRE AND EXPLOSION HAZARD.
- INSPECT SYSTEM REGULARLY. EXAMINE FUEL SYSTEM FOR LEAKS AND CORROSION AT LEAST ANNUALLY.

WLENG0803

⑦ **WARNING**

- AVOID SERIOUS INJURY OR DEATH.
- TOW PYLON SHOULD BE USED ONLY FOR TOWABLE WATER SPORTS DEVICES.
- DO NOT USE TOW PYLON FOR OTHER TOWABLE OBJECTS OR TOWING BOATS.
- TOW PYLON IS NOT DESIGNED FOR VERTICAL EXTENSIONS. ANY MODIFICATIONS TO THE TOW PYLON OR ITS MOUNTINGS MAY RESULT IN DAMAGE TO THE BOAT AND INJURY TO THE USER.
- DO NOT SIT BEHIND THE TOW PYLON WHEN IN USE.

WLSKP0803

*(if equipped with tower)*

⑧ **WARNING**

- AVOID SERIOUS INJURY OR DEATH FROM MISUSE OF TOWER.
- THE TOWER IS DESIGNED TO PULL A SINGLE (1) WAKEBOARDER.
- DO NOT CLIMB OR SIT ON THE TOWER.
- DO NOT SIT BEHIND THE PULLING POINT OF THE TOWER TO AVOID CONTACT WITH ROPE.
- THE TOWER MAY STRIKE LOW OBJECTS. CHECK CLEARANCE HEIGHTS DURING OPERATION AND TOWING.

WLTWR0804

⑨ **WARNING**

**LOOSE FITTINGS  
MAY RESULT IN  
TOWER COLLAPSE.**

**CHECK TIGHTNESS  
OF TOWER BOLTS  
AND KNOBS BEFORE  
EACH USE.**

WLRB0804

Skier's Choice, Inc. reserves the right to change warning labels without notification or incurring obligation. For a copy of the most current warning labels, please contact your dealer or Skier's Choice, Inc.



Reprinted from "Fishing and Skiing Boats Owner's Manual" with permission from the NMMA.

The time to think about emergencies is before they happen. Plan ahead. Know what to do before you encounter any of these situations. Wear a PFD (Personal Flotation Device) when boating.

## EXPLOSION & FIRE

### WARNING

#### EXPLOSION/FIRE/ASPHYXIATION HAZARD

- Open flame cooking appliances consume oxygen. This can cause asphyxiation or death.
- Maintain open ventilation.
- Liquid fuel may ignite, causing severe burns.
- Use fuel appropriate for type of stove.
- Turn off stove burner before filling.
- Do not use stove for comfort heating.

#### FIRE/ASPHYXIATION HAZARD

Use special care with flames or high temperatures near urethane foam, if used in construction of your boat. Burning, welding, lights, cigarettes, space heaters and the like can ignite urethane foam. Once ignited, it burns rapidly, producing extreme heat, releasing hazardous gases and consuming much oxygen.

#### EXPLOSION

- If explosion is imminent, put on PFDs, grab distress signals and survival gear, and immediately abandon ship.

#### FIRE

- Turn off engines, generators, stoves and blowers.
- Extinguish smoking materials.
- Fixed fire suppression system, if equipped, has heat sensors that automatically flood machinery space with a fire extinguishant. Allow extinguishant to "soak" compartment for at least 15 minutes to cool hot metals or fuel before cautiously inspecting fire area. Have portable fire extinguishers ready. Do not breathe fumes or vapors caused by the fire or extinguishant.
- If no fixed firefighting system is installed and fire is in engine compartment, discharge portable fire extinguishers through engine compartment access plate, if equipped. Do not open engine hatch as this feeds oxygen to the fire.
- If you have access to fire, direct contents of extinguishers at base of flames, not at the top.
- Throw burning materials overboard if possible.
- Move anyone not needed for firefighting operations away from the flames.
- Signal for help.
- Put on PFDs (Personal Flotation Devices), grab distress signals and survival gear, and prepare to abandon ship.

## ABANDONING SHIP

### WARNING

#### BURN HAZARD

- Swim against the current or wind if you abandon ship. Leaking fuel will float with the current and may ignite.
- When clear of danger, account for all who were on board, and help those in need.
- Use distress signal.
- Keep everyone together to make rescue easier.

## FLOODING, SWAMPING OR CAPSIZING

- **STAY WITH THE BOAT!** A boat will usually float even if there is major hull damage. Rescuers can spot a boat much easier than a head bobbing in the water.
- Signal for help.

## COLLISION

- Account for everyone on board.
- Check for injuries.
- Inspect structural damage.
- Reduce flooding.
- Signal for help.
- **STAY WITH THE BOAT!**

## GROUNDING

Action depends on how hard the boat hits bottom and whether the boat remains stranded. If it is a simple touch, you may need only to inspect the hull. If you are aground, assess the situation before reacting. In some cases, throwing the boat into reverse can cause more damage.

#### Basic Guidelines

- Inspect damage to hull, propulsion and steering systems.
- Check for leaks. If water is coming in, stopping the flow takes priority over getting free.
- Determine water depth all around the boat and type of bottom (sand, mud, rocks, etc.). This will help you decide which way to move the boat.
- Determine if tide, wind or current will drive the boat harder aground or will help free it.

## LEAKS

- Immediately switch on bilge pumps.
- Assign crew to operate manual pumps, if needed.
- If boat is taking on water, have someone take the helm while you manage damage control.
- Slow or stop to minimize inflow. However, if you can keep a hole above water by maintaining speed, do so.
- If possible, patch the outside with whatever material is available.

## TOWING

### WARNING

#### PERSONAL INJURY HAZARD

***Towing or being towed stresses the boats, hardware and lines. Failure of any part can seriously injure people or damage the boat.***

A recreational boat towing another is usually a last resort because of possible damage to one or both boats. The Coast Guard or a private salvage company is better equipped. A recreational boat may assist by standing by, and possibly keeping the disabled boat's bow at a proper angle until help arrives. Only when conditions are ideal—that is, waters are calm, disabled boat is small, and one or both skippers know correct technique—should a recreational boat tow another.

#### Towing Vessel

- Be sure your boat will not run aground too.
- Because you are maneuverable and the grounded boat is not, you should pass the towline to the grounded boat.
- Use double-braided or braid-on-braid line. Never use three strand twisted nylon; it has too much elasticity and can snap back dangerously.
- Fasten the towline as far forward as possible on the upwind or up-current side of the towing boat. Fastening it to the stern will restrict maneuverability of the towing boat.
- If possible, use a bridle.
- Move slowly to prevent sudden strain on slack line.
- Be ready to cast loose or cut the line if the towing situation becomes hazardous.

#### Vessel Being Towed

- Attach the towline to the bow eye.
- If the boat has eyebolts in the transom for pulling skiers, a towline may be attached to a small bridle hooked to both eyebolts.
- If it is necessary to be towed after being freed, keep someone at the wheel to steer.

## Both Vessels

- If you attach the towline to a fitting, be sure the fitting is fastened with a through bolt and is reinforced on the underside.
- Creating a bridle with a line around the hull or superstructure will distribute the load over a wide area; pad pressure points. This technique can be used on both the towing and towed boat.
- Keep lines clear of propellers on both boats.
- Keep hands and feet clear of the other boat.
- Never hold a towline after it is pulled taut.

## PERSON OVERBOARD

- Immediately sound an alarm and keep pointing to the person overboard.
- Throw a life preserver even if the person is wearing a PFD. It will serve as a marker.
- Immediately stop or slow the boat, then circle toward the victim.
- Keep person overboard on helm side so operator has the person constantly in sight.
- Approach from downwind and move alongside into the wind for pickup.
- When almost alongside, stop the engine in gear to prevent dangerous propeller "windmilling."
- As part of your emergency plan, consider what to do if you were alone and fell overboard (*e.g., wear PFD, keep signal device in PFD, attach emergency stop switch lanyard to yourself*).

## DROWNING

- Swim to rescue a drowning victim only as a last resort.
- Immediate resuscitation is critical! At least two people on board should be certified in CPR.
- Keep the victim warm.
- Use care in handling. Spinal injury may exist if the victim fell overboard.
- Signal for help.

## MEDICAL EMERGENCY

- In an emergency, you may be far from professional medical assistance. Be prepared. Take a first aid course, and carry a first aid kit. Be aware of special conditions that may affect anyone on board.

## CARBON MONOXIDE

Carbon monoxide is an odorless, colorless, extremely toxic gas. Symptoms of carbon monoxide poisoning are dizziness, ears ringing, headaches, nausea and unconsciousness. A poisoning victim's skin often turns cherry red.

Have the victim breathe fresh air deeply. If breathing stops, resuscitate. A victim often revives, then relapses because organs are damaged by lack of oxygen. Seek immediate medical attention.

## PROPULSION, CONTROL OR STEERING FAILURE

- Shut off engine.
- Put out an anchor to prevent drifting.
- Determine if you can fix the problem yourself. See engine operator's manual if engine is flooded.
- Signal for help.

## RADIO COMMUNICATION

Radio is the boat operator's main method of receiving safety information and summoning aid. VHF-FM radio is the primary means of short-range communication. Single sideband radio (SSB) is used for longer range communication.

VHF-FM Channel 16 and SSB 2182 kHz are designated for emergency use. Such situations can be categorized as:

- **Emergency** - "MAYDAY, MAYDAY, MAYDAY" - Used when a life or vessel is in imminent danger.
- **Urgency** - "PAN-PAN, PAN-PAN, PAN-PAN" (pronounced PAHN-PAHN) - Used when a person or vessel is in some jeopardy less than indicated by a Mayday call.
- **Safety** - "SECURITY, SECURITY, SECURITY" (pronounced SAY-CURE-IT-TAY) - Used for navigational safety or weather warning.

An emergency situation will be hectic and there will not be time to learn proper radio procedure. LEARN WHAT TO DO BEFORE YOU NEED TO DO IT.

If you hear a distress call, stop all radio transmissions. If you can directly assist, respond on the emergency frequency. If you cannot assist, do not transmit on that frequency. However, continue to monitor until it is obvious that help is being provided.

Consult your national boating law enforcement agency.

## VISUAL DISTRESS SIGNALS

U.S. Coast Guard regulations require boats in coastal waters and the Great Lakes to carry visual distress signals for day or night use, as appropriate for the time of operation. Exempt from the day signals requirement, but not night signals, are boats less than 4.8 meters (16 feet), open sailboats less than 7.9 meters (26 feet), boats participating in organized events, and manually propelled boats.

- If you are required to have visual distress signals, at least three safety-approved pyrotechnic devices in serviceable condition must be readily accessible. They must be marked with a date showing the service life, which must not be expired.
- Carry three signals for day use and three signals for night use. Some pyrotechnic signals, such as red flares, meet both day and night use requirements.
- Store pyrotechnic signals in a cool, dry location. An orange or red watertight container prominently marked "Distress Signals" is recommended.

### Other recognized visual distress signals include:

- Flames in a bucket
- Code flags November and Charlie
- Square flag and ball
- Black square and ball on orange background flag
- Orange flag (certified)
- Electric distress light (certified) - for night use only.
- Dye marker (any color)
- Person waving arms
- U.S. ensign flown upside down

### Audible Distress Signals

U.S. Coast Guard regulations require one hand, mouth or power-operated whistle or horn, audible for at least a half mile.

### Other recognized audible distress signals include:

- Radio communication (see Emergency Procedures - Radio Procedures - Radio Communication)
- Radiotelegraph alarm
- Position indicating radio beacon
- Morse Code SOS (3 short, 3 long, 3 short) sounded by any means
- Fog horn sounded continuously





## BASIC BOATING RULES

You should be aware of these rules and follow them whenever you encounter another vessel on the water.

The rules presented in this manual are condensed and have been provided as a convenience only. Consult your local U.S. Coast Guard Auxiliary (USCGA) or Department of Motor Vehicles (DMV) for a complete set of rules governing the waters in which you will be using your boat. If you plan to travel—even for a short trip—you would be well served to contact the regional USCGA or DMV in the area where you will be boating.

### Review and understand all local and state laws.

Any time two vessels on the water meet one another, one vessel has the right-of-way. It is called the *stand-on* vessel. The vessel which does NOT have the right-of-way is called the *give-way* or *burdened* vessel.

These rules determine which vessel has the right-of-way, and accordingly, what each vessel should do.

The vessel with the right-of-way has the duty to continue its course and speed, except to avoid an immediate collision. When you maintain your direction and speed, the other vessel will be able to determine how best to avoid you.

The vessel which does not have the right-of-way has the duty to take positive and timely action to stay out of the way of the *stand-on* vessel. Normally, the *give-way* vessel should not cross in front of the *stand-on* vessel. Slow down or change directions briefly and pass behind the other vessel. You should always move in such a way that the *stand-on* operator can see what you are doing.

This rule is called Rule 2 in the International Rules and says, *"In obeying and construing these rules due regard shall be had to all dangers of navigation and collision, and to any special circumstances, which may render a departure from the above rules necessary in order to avoid immediate danger."*

## ENCOUNTERING OTHER VESSELS

There are three main situations in which you may encounter other vessels and you must observe the Steering Rules in order to avoid a collision. These are:

- **Meeting** (you are approaching another vessel head-on)
- **Crossing** (you are traveling across the other vessel's path)
- **Overtaking** (you are passing or being passed by another vessel)

Using the following illustration in which you are the boat in the center, you should give right-of-way to all vessels shown in the white area. In this instance, you are the give-way vessel. All vessels in the shaded area must yield to you as you are the stand-on vessel. Both you and the meeting vessel must alter course to avoid each other.

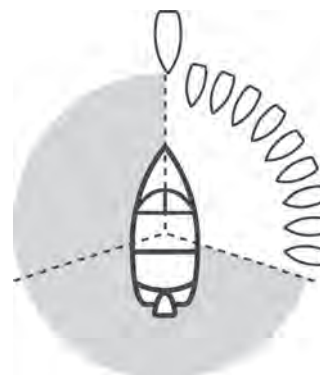

If you are meeting another power vessel head-on, and you are close enough to run the risk of collision, neither of you has the right-of-way. Both of you should alter course to avoid an accident. You should keep the other vessel on your port (left) side. This rule doesn't apply if both of you can clear each other by continuing your set course and speed.

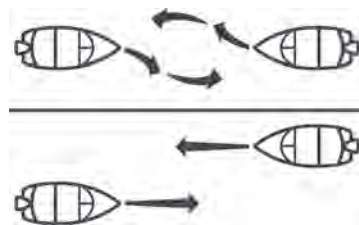

When two power-driven vessels are crossing each other's path close enough to run the risk of collision, the vessel that views the crossing vessel to the starboard (right) side must give-way.

If the other vessel is to the port (left) side, maintain your course and direction, provided the other vessel gives you the right-of-way as it should.

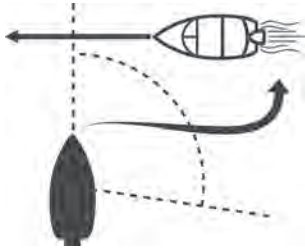

If you are passing another vessel, you are the give-way vessel. This means that the other vessel is expected to maintain its course and speed. You must stay out of its way as you clear it, altering course and speed as necessary.

Conversely, if you are being passed by another vessel, you should maintain your speed and direction so that the other vessel can steer itself around you.

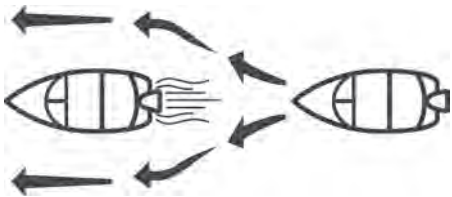

There are three other rules to always remember when driving your boat around other vessels.

When navigating in narrow channels, you should keep to the right when it is safe and practical to do so. If the operator of a power-driven vessel is preparing to go around a bend that may obstruct the view of other water vessels, the operator should sound a prolonged blast on the whistle or horn—four to six seconds.

If another vessel is around the bend, it too should sound the whistle or horn. Even if no reply is heard, however, the vessel should still proceed around the bend with caution.

If you navigate these type of waters, you should carry a portable air horn, which are available from local marine supply stores.

All vessels which are fishing with nets, lines or trawls are considered under International Rules to be fishing vessels. Boats with trolling lines are not considered fishing vessels.

Fishing vessels have the right-of-way, regardless of position. These vessels, however, cannot impede the passage of other vessels in narrow channels.

Sailing vessels should normally be given the right-of-way. The exceptions to this are:

- When the sailing vessel is overtaking the power-drive vessel, the power-driven vessel has the right-of-way.
- Sailing vessels should keep clear of any fishing vessel.
- In a narrow channel, a sailing vessel should not hamper the safe passage of a power-driven vessel which can navigate only in such a channel.

The waters of the United States are marked for safe navigation by the lateral system of buoyage. The markers and buoys you will encounter have an arrangement of shapes, colors, numbers and lights to show which side of the buoy a boater should pass when navigating in a particular direction.

The markings on these buoys are oriented from the perspective of being entered from seaward while the boater is going towards the port. This means that red buoys are passed on the starboard (right) side when proceeding from open water into port, and black buoys are to port (left) side. When navigating out of port, your position to the buoys should be reversed: red buoys to port and black buoys to starboard.

Many boating bodies of water are entirely within the boundaries of a single state. The Uniform State Waterway Marking Systems has been devised for these waters. This system uses buoys and signs with distinctive shapes and colors to show regulatory or advisory information.

These markers are white with black letters and orange borders. The information signifies speed zones, restricted areas, danger areas and general information.

Remember: Markings may vary by geographic location. Always consult local boating authorities before driving your boat in unfamiliar waters.

***(See examples of buoys and markers next page.)***

# BUOYS & MARKERS

<p>Proceeding forward head of navigation from seaward</p> <p><b>BUOY COLOR CODE</b></p> <ul style="list-style-type: none"> <li>BLACK</li> <li>RED</li> <li>GREEN</li> </ul>	<p><b>MAIN CHANNEL BUOYS</b></p> <p>◇ 1, 3, 5, ○ RB L or RG L</p> <p><b>LIGHTED BUOY (Port Hand)</b></p> <p>Odd number, increasing toward head of navigation. Leave to port (left) proceeding upstream.</p>
<p><b>SECONDARY CHANNEL BUOYS</b> STARTS NEW NUMBERING SYSTEM</p> <p>◇ c1</p> <p><b>CAN BUOY</b></p> <p>Odd number. Leave to port.</p>	<p>◇ 2, 4, 6, ○ RB L or RG L</p> <p><b>LIGHTED BUOY (Starboard Hand)</b></p> <p>Even number, increasing toward head of navigation. Leave to starboard (right) proceeding upstream.</p>
<p>◇ N2</p> <p><b>NUN BUOY</b></p> <p>Even number. Leave to starboard.</p> <p>no change</p>	<p>◇ A</p> <p><b>LIGHTED SAFE WATER BUOY</b></p> <p>No number. Marks mid-channel. Pass on either side. Letter has no lateral significance; it is used for identification and location purposes.</p>
<p>◇ RB L, ○ RG L</p> <p><b>LIGHTED PREFERRED CHANNEL TO PORT BUOY</b></p> <p>No number. Topmost band red; preferred channel is to the left of the buoy. Letter has no lateral significance; it is used for identification and location purposes.</p>	



**OUTBACK**

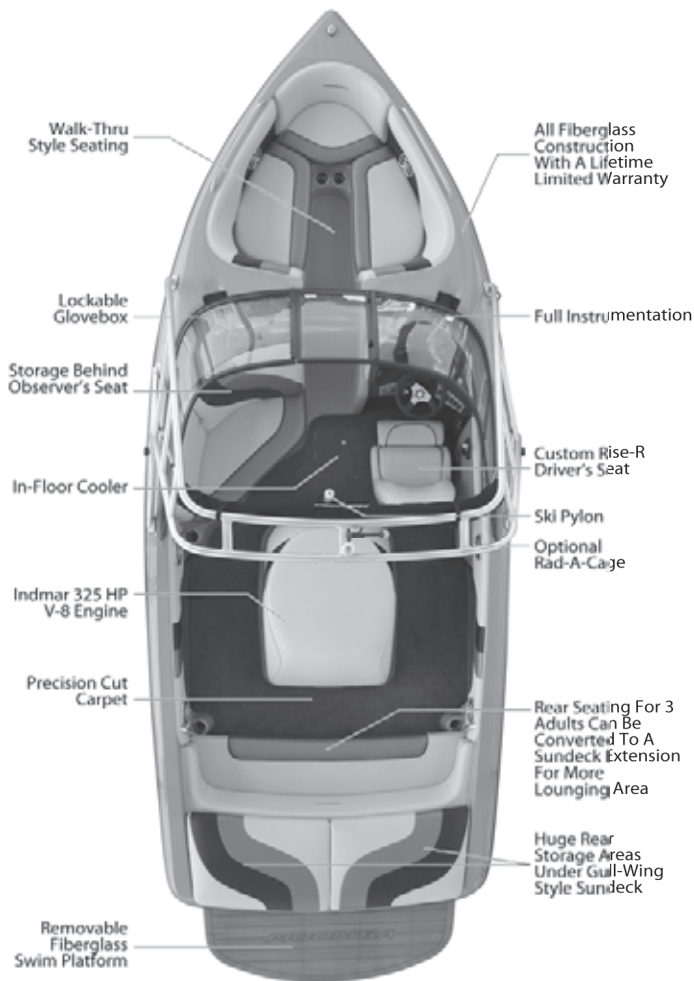

**OUTBACK V**

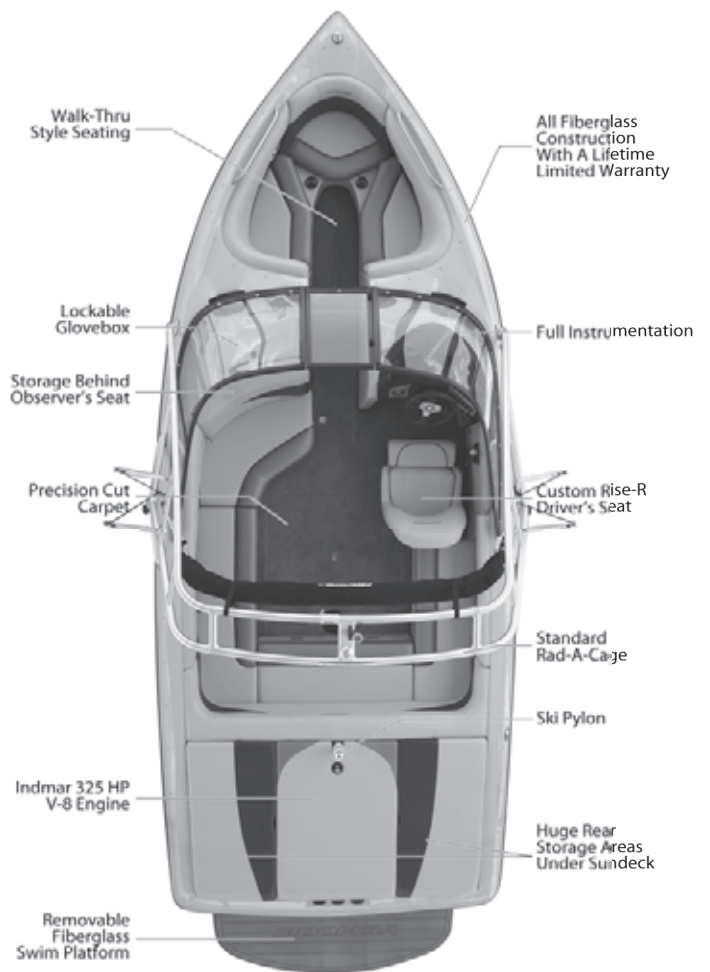

**SPECIFICATIONS:**

Length without Platform:	20' 6"—(6.25M)
Length with Platform:	22' 6"—(6.86M)
Length with Trailer:	23' 10"—(7.26M)
Width (Beam):	95"—(2.41M)
Overall Width with Trailer:	102"—(2.59M)
Draft:	22"—(0.56M)
Weight (Boat Only):	2,750 lbs.—(1,247KG)
Weight (Boat & Trailer):	3,600 lbs.—(1,633KG)
Capacity - Passenger:	10
Capacity - Weight:	1,400 lbs.—(635KG)
Capacity - Fuel:	28 gals.—(106L)
Standard Power:	325 HP, V-8—(5.7L)

**SPECIFICATIONS:**

Length without Platform:	20'—(6.10M)
Length with Platform:	22'—(6.71M)
Length with Trailer:	24' 2"—(7.37M)
Width (Beam):	96"—(2.44M)
Overall Width with Trailer:	102"—(2.59M)
Draft:	24"—(0.61M)
Weight (Boat Only):	3,200 lbs.—(1,452KG)
Weight (Boat & Trailer):	4,050 lbs.—(1,837KG)
Capacity - Passenger:	12
Capacity - Weight:	1,700 lbs.—(771KG)
Capacity - Fuel:	39 gals.—(148L)
Standard Power:	325 HP, V-8—(5.7L)

## MOBIUS LSV

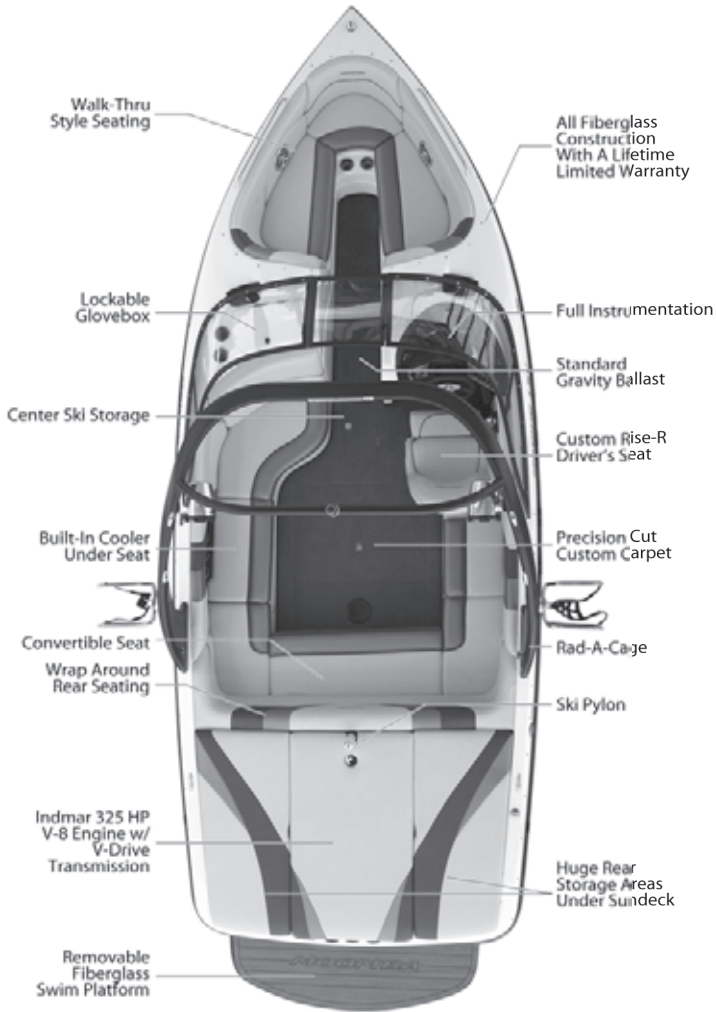

## MOBIUS XLV & GRAVITY EDITION

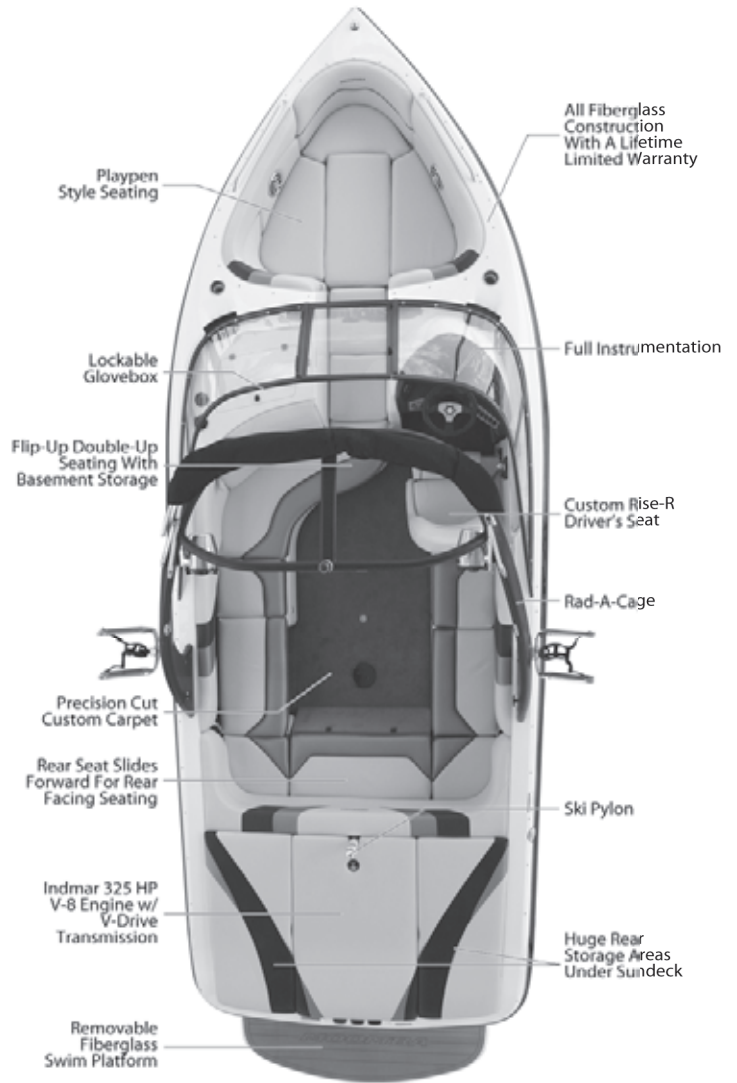

### SPECIFICATIONS:

Length without Platform:	21' 6" — (6.55M)
Length with Platform:	23' 6" — (7.16M)
Length with Trailer:	25' 3" — (7.70M)
Width (Beam):	97" — (2.46M)
Overall Width with Trailer:	102" — (2.59M)
Draft:	24" — (0.61M)
Weight (Boat Only):	3,300 lbs. — (1,497KG)
Weight (Boat & Trailer):	4,150 lbs. — (1,882KG)
Capacity - Passenger:	13
Capacity - Weight:	1,800 lbs. — (816KG)
Capacity - Fuel:	39 gals. — (148L)
Standard Power:	325 HP, V-8 — (5.7L)

### SPECIFICATIONS:

Length without Platform:	23' — (7.01M)
Length with Platform:	25' — (7.62M)
Length with Trailer:	26' 8" — (8.13M)
Width (Beam):	98" — (2.49M)
Overall Width with Trailer:	102" — (2.59M)
Draft:	26" — (0.66M)
Weight (Boat Only):	3,600 lbs. — (1,633KG)
Weight (Boat & Trailer):	4,700 lbs. — (2,132KG)
Capacity - Passenger:	16
Capacity - Weight:	2,300 lbs. — (1,043KG)
Capacity - Fuel:	50 gals. — (189L)
Standard Power:	325 HP, V-8 — (5.7L)



## BREAK IN

Taking care to properly break in your new engine will pay off in the long run. In our years of field testing, we have proven that an Indmar engine, when properly broken in according to our simple procedures, will last longer, run better and have fewer repairs over its lifetime.

Your new engine does not require an elaborate break-in procedure. Just follow these simple instructions and you are off to a great start.

The three (3) most important aspects of new engine break-in are:

- Avoid running engine at high speeds.
- Do not carry a heavy load (passengers, gear, etc.).
- Vary your boat speed during break-in. Do not run at the same RPM for a long period of time.

## BREAK-IN STEPS

- For the first hour, do not exceed 2,000 RPM.
- For the second hour, do not exceed 3,000 RPM.
- For the next five hours, do not exceed 4,000 RPM.

## BREAK-IN TIPS

- Avoid fast accelerations and do not carry (or pull) a heavy load during this period.
- Always let engine warm up gradually before acceleration.
- Check oil frequently. During the first 50 to 100 hours, an engine can use more oil than usual. Maintain oil at a proper level at all times (do not overfill).
- Monitor transmission fluid levels.
- Report abnormal noises or vibrations to your dealer.
- Keep an eye out for loose mountings, fittings, nuts, bolts, and clamps.

During the BREAK-IN process, engine temperature should be carefully monitored and speed should be reduced if overheating is evident. **ALSO, PLEASE REFER TO ENGINE OWNER'S MANUAL FOR BREAK-IN INFORMATION.**

**NOTICE: PLEASE REFER TO ENGINE OWNER'S MANUAL for maximum RPM and engine break-in procedure.**

After the first 10 to 20 hours of operation, take your boat to the dealer for its first oil and filter change, as well as an engine checkup. Remember to keep a sharp eye on all gauges and warning lights during these first hours of operation. Report anything unusual to your dealer.

After the break-in procedure is over, your boat may be operated continuously at any speed.

## CAUTION

**Do not exceed maximum RPM recommended for your engine. Exceeding the maximum RPM may result in damage to the engine.**

## DANGER

**Before starting your engine you must open the engine box and check engine compartment and bilge for gasoline and oil vapors.**

## MAXIMUM CAPACITIES



In compliance with United States Coast Guard Regulations, Moomba Boats meet or exceed all safety standards designed for recreational boats. To ensure safe handling and performance, each Moomba boat displays a maximum capacity sticker (see sample), stating the maximum passenger weight load allowable.

**NOTE: Refer to the Maximum Capacity Sticker on your boat for allowable loading.**

### **⚠ WARNING**

**Do not exceed the maximum capacity of the boat.**

## COAST GUARD REGULATIONS

The United States Coast Guard boating regulations prescribe minimum standards of safety to be met and maintained by all watercraft. It is necessary that your boat remain in compliance with these regulations.

The staff at Skier's Choice, Inc. recommend that all boat operators complete a Coast Guard approved boating safety course.

## CANVAS COVER



Your Moomba boat cover is made from the finest canvas and webbing to ensure that your boat will be protected in the off season. The cover has been designed to fit securely around each boat. If your new cover does not seem to be snug, a shrinkage allowance has been sized in.

### **Use the following procedure when covering the boat:**

- Be sure that the cover fits snugly at the bow then unfold from front to back.
- Be sure to install cover pole(s) and adjust to proper height, using set screw on pole(s). This will keep water from gathering in the center, which can damage the cover.
- Secure all fastening straps around the trailer frame.
- Pull the draw cord equally from both sides and tie off to the lifting eyes on the stern in accordance with the illustration.

### **Folding Cover**

When folding the cover for storage, be sure the cover is dry. Take care not to scratch the canvas finish against rough surfaces. Store in a dry location.

### **Cover Repair**

If the cover becomes damaged, immediately patch and reseal the area. Use a tent seam sealer to reseal any new stitches. Spray fabric guard on scraped or worn surfaces. Canvas tears should be repaired professionally and stitches sealed to prevent leakage.

### **⚠ CAUTION**

Your mooring cover is not designed for trailering. Trailering with your cover installed may cause premature cover failure and boat damage. This damage is not warrantable.



**A standard pre-starting procedure should be always be followed before the first start-up of the day.**

1. Check the engine oil level.
2. Check for gasoline fumes in bilge or engine compartment.
3. Operate engine blower for four minutes before starting the engine to remove any fumes.
4. Check manual operation of bilge pump. Make sure bilge areas are empty.

Other items might also be inspected, depending on the boat and its use. It is advisable to formulate a check list particular to the equipment and operation of your boat.

**REFER TO THE BOATMAN'S CHECKLIST OF THIS MANUAL.**

Consult the local Coast Guard Auxiliary or Power Squadron for full details on boating safety.

**NOTE:** Add-on electrical accessories should never be connected to the ignition terminal or ignition circuit.

**IMPORTANT:** DO NOT continue to operate the starter for more than 15 seconds at a time without pausing to allow the starter motor to cool down for at least two minutes. This will also allow the battery to recover between starting attempts. PLEASE REFER TO ENGINE OWNER'S MANUAL FOR ADDITIONAL DETAILS.

** DANGER**

**Do not start engine if gas fumes are present!**

** DANGER**

**BEFORE STARTING ENGINE, BE SURE THAT THE SHIFT SELECTOR IS IN NEUTRAL.**

The correct starting procedure depends upon the type of engine. Please refer to the engine manual before starting.

**To START ELECTRONIC FUEL INJECTION (EFI) ENGINE**

- Place shift selector in Neutral with the throttle in the upright (zero) position. (If throttle is not in the idle position, the throttle position sensor will not allow the engine computer to proceed with a normal starting procedure).
- Turn Ignition Key to Start Position to operate the starter.
- Release the key when engine starts (key will return to run position).
- Allow the engine to establish a good idle (30 to 60 seconds) before getting underway.
- Shift slowly into forward or reverse, allowing the transmission time to engage before powering up.
- With the transmission disengaged, push the lever forward to full throttle position. (This will cause the computer to shut off the fuel injectors, which will allow the engine to clear of excess fuel during starting).
- Turn the Ignition Key to Start Position and operate the starter for no more than 15 seconds at a time, until the engine starts.
- When the engine starts, back off the throttle and allow the engine to establish a good idle (30 to 60 seconds).
- Return the throttle to idle position and the transmission lockout will automatically reengage the transmission in neutral position.
- When ready to get underway, shift slowly into forward or reverse, allowing the transmission time to engage the gearing before powering up.

**NOTE: It is normal for the idle to speed up in cold start conditions.**

** CAUTION**

**DO NOT continue to operate the starter for more than 15 seconds at a time without pausing to allow the starter motor to cool down for at least two minutes.** This will also allow the battery to recover between starting attempts. **PLEASE REFER TO ENGINE OWNER'S MANUAL FOR ADDITIONAL DETAILS.**

**NOTE: Should the EFI engine become "flooded" use the following procedure to start:**

- Place shift selector in Neutral and disengage the transmission by pushing the transmission lockout button located at the bottom of the lever.

**WARM-UP**

Always let engine warm up to normal operating temperature before accelerating.

## THROTTLE LEVER



The throttle lever controls both the throttle and the transmission. The idle position (normally vertical) is the zero throttle position and the neutral position for the transmission. A safety ring (umbrella) keeps the lever from being accidentally moved to engage the transmission.

To place the transmission into gear, with your hand placed over the lever ball, pull up on the safety ring (umbrella) and slowly push the lever into forward gear or slowly pull the lever back into reverse gear.

### CAUTION

Never shift the lever directly from the neutral (vertical) position into a speed position.

- To prevent damage to the transmission, always allow the transmission time to engage before accelerating the engine.
- Once the transmission is engaged, you may accelerate as quickly as you like.



The Transmission Lockout button allows the transmission to be disengaged while giving the throttle full operating range. With the lever in the idle position (normally vertical), push the button located at the bottom of the lever to disengage the transmission. The throttle may then be operated in any open position (forward of neutral or back of neutral upright position). Return the throttle to idle position, and the transmission lockout will automatically reengage the transmission in neutral position.

## CENTER DRAIN PLUG-DIRECT DRIVE MODELS

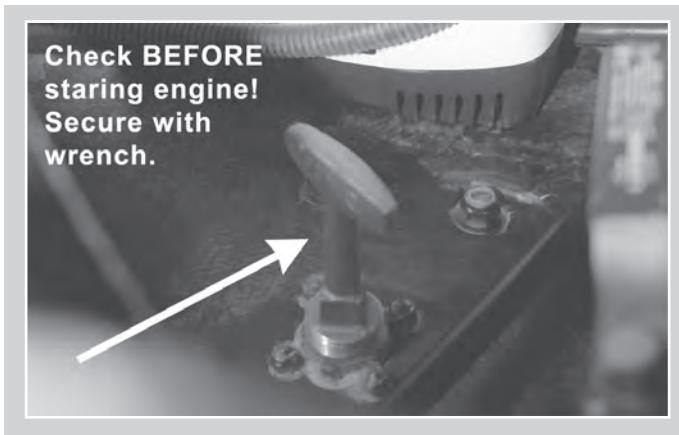

The bilge area drain plug is located at the front of the motor well, in the center under the engine. It is extremely important that the drain plug is always checked before starting the engine. The drain plug should be secured in place using a wrench.

### **⚠ WARNING**

**DO NOT start engine until center drain plug is checked and secured in place. DO NOT try to install center drain plug while engine is running.**

### **⚠ CAUTION**

Some Moomba models **DO NOT** have mechanical devices to hold the motor box cover in the open position. Please use caution to prevent accidental closing.

## REAR DRAIN PLUG

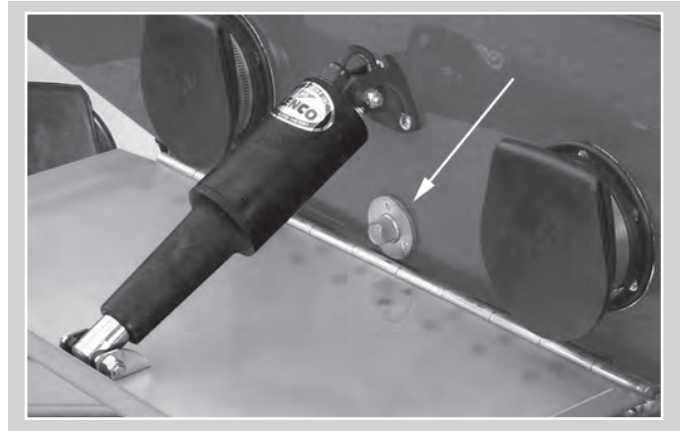

The rear drain plug is located at the back of the boat, near the bottom of the transom. It is extremely important that the drain plug is always checked before starting the engine. The drain plug should be secured in place using a wrench.

### **⚠ WARNING**

**DO NOT start the engine until the drain plug is checked and secured in place. DO NOT try to install the drain plug while the engine is running!**

## CENTER DRAIN PLUG -V-DRIVE MODELS

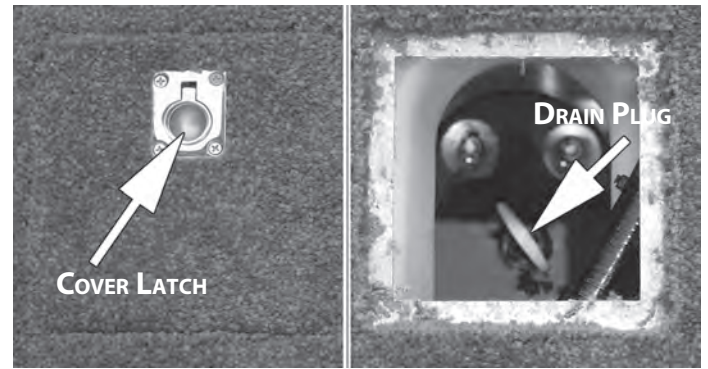

On V-drive models the center drain plug is accessed via the access cover in the center floor panel.

It is extremely important that the drain plug is always checked before starting the engine. The drain plug should be secured in place using a wrench.

### **⚠ WARNING**

**DO NOT start engine until center drain plug is checked and secured in place.**

## FUEL PRECAUTIONS



### **Indmar Assault MPI 325 & Assault 340**

Use a gasoline with a minimum octane rating of 89. See engine owner's manual for more information.

### **Indmar Assault MPI 409**

Use a gasoline with a minimum octane rating of 92. See engine owner's manual for more information.

#### **WARNING**

**DO NOT use gasoline containing methyl alcohol (methanol). Methanol can damage your boat's fuel system.**

#### **CAUTION**

**E-10 fuels require fuel stabilizers that are specifically designed for E-10 fuels to help prevent moisture absorption, phase separation and gasoline stabilization.**

#### **CAUTION**

Gasoline stabilizer should be added to the fuel tank when the boat is used infrequently or whenever your boat will not be used for two weeks or more. During storage always add gasoline stabilizer to reduce gumming or tank sludge.

## FILLING THE TANK

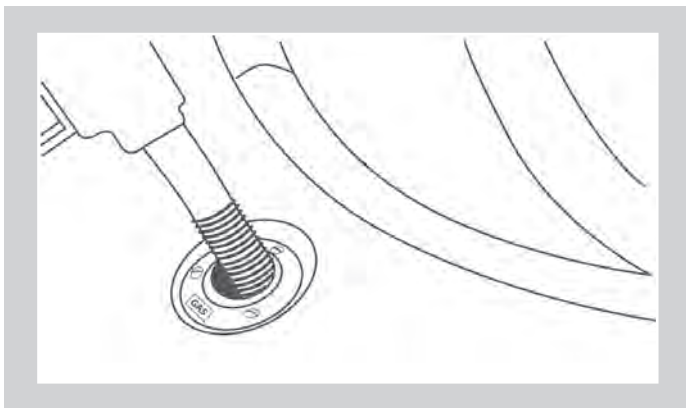

#### **CAUTION**

**Be especially careful when filling the fuel tank. DO NOT over fill the tank. Fuel may empty through the fuel vent and damage to finishes could result.**

If fuel is spilled on stripes or decals, apply a common bath cleaner (nonabrasive) and wipe with a damp cloth. Rinse the spill area with clean water.

## FUELING



#### **WARNING**

**Sparks while fueling could cause an explosion!**

#### **BEFORE FUELING:**

1. Turn off engine.
2. Turn off ignition.
3. Extinguish cigarettes or any open flame.

#### **WHILE FUELING:**

- Keep hose nozzle in contact with fill pipe to provide a ground against static sparks.
- Fill tank at a slow rate to avoid any spillage.

## FUEL CAP



The fuel cap is located on the rear deck near the stern. To open, lift "GAS" tab and turn.

**NOTE: The cap is sealed by a rubber O-ring. Please do not over tighten.**

**MOOMBA DASH**



**SPEED CALIBRATION**



Speed may be checked using a stopwatch and a standard slalom course. Adjust the speedometer needle by twisting the adjuster knobs located beneath the dash panel.

Speed can also be set by using a hand-held GPS.

**SLALOM COURSE SPEEDS**

(Times are from start gate to end gate)



MPH	SECONDS	ALLOWABLE
+ or - 1/2 MPH		
18	32.19	32.0 - 32.6
20	28.97	28.0 - 28.6
30	19.31	19.0 - 19.6
32	18.11	17.9 - 18.3
34	16.95	16.8 - 17.2
36	16.08	15.9 - 16.3

**BLANK GAUGE**

The Moomba dash has extra slots for gauges for accessories. If you add options in the future that have a 2 inch gauge (i.e. wakeplate, depth finder, etc.) this blank gauge can be removed and the accessory gauge can be added in its place.



## Warning Stickers

Always heed the dash mounted warning stickers.



**GASOLINE VAPORS CAN EXPLODE!**

### BEFORE STARTING ENGINE:

- Check engine compartment for gasoline or vapors.
- Operate blower for four minutes before starting engine.
- Run blower below cruising speed.
- Turn off engine before using ski platform.

## SPEEDOMETER



The speedometer indicates the water speed of the boat in miles per hour. It is recommended that the speedometer be checked for accuracy after each 100 engine hours.

Speed may be checked using a stopwatch and a standard slalom course. Adjust the speedometer needle by turning the knob at the bottom of the gauge.

**NOTE: If the speedometer registers erratically, check speedometer pickups.**

### FUEL GAUGE

The fuel gauge is located on the speedometer. This gauge indicates the approximate quantity of fuel remaining in the tank when the ignition switch is in the "ON" position.

**NOTE: DO NOT run the tank to empty. To prevent condensation from forming in the tank, it is recommended that the tank be filled when the gauge indicates 1/4 tank of fuel remaining.**

## TACHOMETER



The tachometer registers the operating speed of the motor's shaft output and may be used as an alternative to speedometer if weight and water conditions permit.

DO NOT exceed the recommended RPM during break-in and normal operation of your motor. Exceeding the manufacturer's suggested RPM may cause damage to the engine.

### ENGINE HOURS

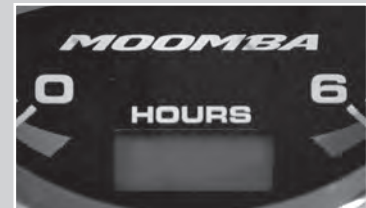

ENGINE HOURS are shown on the face of the tachometer. The engine hour gauge acts as an odometer for the engine.

Engine hours should always be noted and documented so that required maintenance and lubricant changes may be performed at the proper intervals.

## SPEEDOMETER PICKUPS



The speedometer pickup is located on the bottom of the hull. The pickup measures the speed of water passing the paddlewheel. Poor water conditions or foreign material may clog the pickup causing the speedometer to register incorrectly.

Inspect the paddlewheel and remove any foreign material only when engine is off. Please see paddlewheel owner manual in the Boat Owner's Packet for more information.

## VOLTMETER (INBOARD)



The voltmeter indicates whether the battery is charging or discharging. The needle should be located in the normal range while the engine is running.

If the voltmeter does not register in the normal range, there may be a problem within the electrical system. It is normal for the voltmeter needle to fall when starting the engine. Normal range is 12 to 14 volts.

## TEMP GAUGE



The temperature gauge indicates the engine coolant temperature while the coolant is circulating inside the engine. Engine operating temperatures will vary depending on the weather conditions and engine load. Normal operating temp range is between 160 degrees and 180 degrees.

**NOTICE:** Refer to your Engine Owner's Manual for additional details.

## OIL PRESSURE GAUGE



The oil pressure gauge indicates the oil pressure in the engine while the engine is running.

If the oil pressure remains below the normal range of 10 to 80 psi, stop the engine immediately. If engine is allowed to run while oil pressure is too low, permanent engine damage may occur.

**⚠ CAUTION**

Running the engine with low oil pressure may cause severe engine damage.

## DEPTH SOUNDER



### Setting Units

The depth sounder can display depth in either standard or metric units.

#### Perform the following steps to change the display units:

- Simultaneously press the up and down buttons. Either the FT or M units indicator display text will flash.

#### THEN...

- To set feet units, press the up button. The FT indicator display text will flash for five seconds and return to normal mode display with feet as the current units.

#### OR...

- To set meter units, press the down button. The M indicator display text will flash for five seconds and return to normal mode display with meters as the current units.

**NOTE: When power is applied or removed and reapplied, the units display defaults to feet units.**



### Setting Deep Alarm

The deep alarm function can be set for depths ranging from 3 feet (1.0 meter) to 200 feet (60.9 meters). An alarm triggers when the water depth is greater than the set value.

### Setting Deep Alarm (continued)

To set the deep alarm, perform the following:

1. Press the down button. The current deep alarm depth setting will display.
2. Press the up or down button to increase or decrease respectively the deep alarm depth value. Pressing either button once will change the depth value in 1-foot or 0.1 meter increments. Holding either button will change the depth value in 9-foot or 1-meter increments per second.
3. After setting the depth value, the alarm and down arrow icons will blink for five seconds. Then the display will return to normal operating mode with the alarm and down arrow icons displayed.

When triggered, an audible alarm sounds for ten seconds while flashing the warning LED, alarm and down icons on the display. After ten seconds, the audible alarm mutes but the LED and display icons continue to flash.

**NOTE: When power is removed from the instrument, all depth settings are returned to "000".**

### Setting Shallow Alarm

The shallow alarm function can be set for depths ranging from 3 feet (1.0 Meter) to 200 feet (60.9 Meters). An alarm triggers when the water depth is less than the set value.

To set the shallow alarm, perform the following:

1. Press the up button. The current shallow alarm depth setting will display.
2. Press the up or down button to increase or decrease respectively the shallow alarm depth value. Pressing either button once will change the depth value in 1-foot or 0.1 meter increments. Holding either button will change the depth value in 9-foot or 1-meter increments per second.
3. After setting the depth value, the alarm and up arrow icons will blink for five seconds. Then the display will return to normal operating mode with the alarm and up arrow icons displayed.

When triggered, an audible alarm sounds for ten seconds while flashing the warning LED, alarm and up icons on the display. After ten seconds, the audible alarm mutes, but the LED and display icons continue to flash.

**NOTE: When power is removed from the instrument, all depth settings are returned to "000".**



## Out of Range Display



If the display indicates three horizontal bars as shown, the depth sounder indicates an out of range, inaccurate or incomplete data condition.

An out of range condition occurs when the depth reading is less than 2.5 feet (3.0 meters) or greater than 200 feet (60.9 meters).

Inaccurate or incomplete data will cause an out of range condition when operating in extremely dirty water, very soft bottom or at high speeds. A faulty or improper transducer connection can also cause an out of range error condition.

## TROUBLESHOOTING

### Instrument Does Not Turn On

- If applicable, check main power supply fuse to the unit. If it is blown, replace it with a 1 amp, normal blow fuse. If in-line fuse is used, clean all corrosion from the fuse housing or replace the fuse holder assembly if necessary.

### Instrument Does Not Turn On (continued)

- Check the power cable connection. Be sure that the unit is connected to a known power source:
- RED wire to positive, BLACK wire to negative or ground.
- Ensure that the power source is powered using a test light or some other reliable form of testing 12 volt power.
- If you are sure that the unit is receiving power and is still not functioning, please contact Customer Service for assistance.

### Random or Flashing Bottom Reading

- Under certain circumstances, the depth sounder may not perform at the best of its ability. Extremely dirty water, very soft bottom, high speeds, deep water, or a combination of the above will result in incomplete or inaccurate readings.
- Check the transducer cable connection on the back of the unit.
- Contact Customer Service for assistance if you are unable to correct the problem.

## User Interface/Display Features

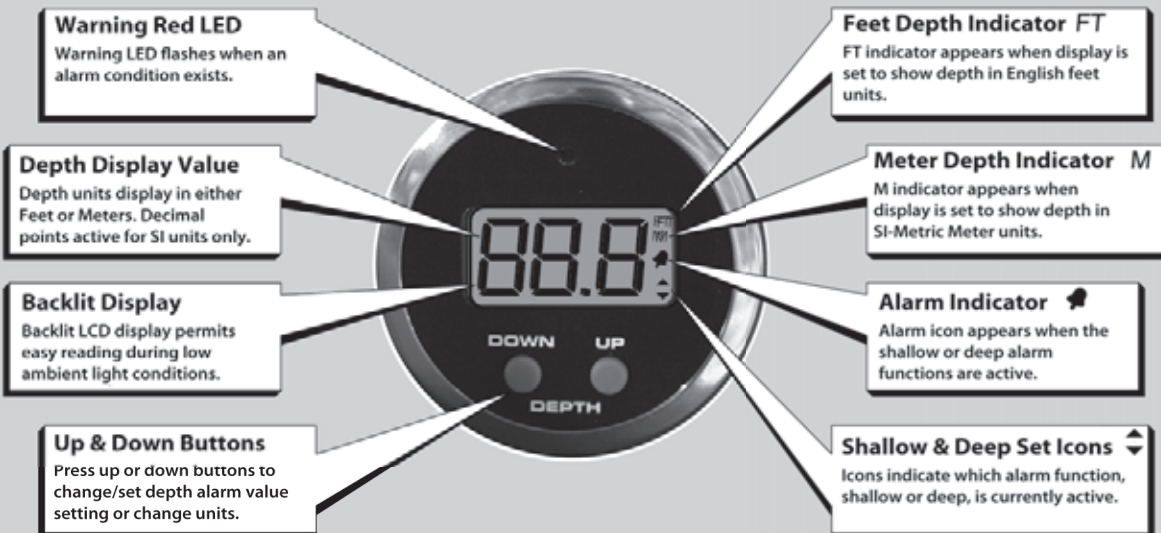

## STEREO

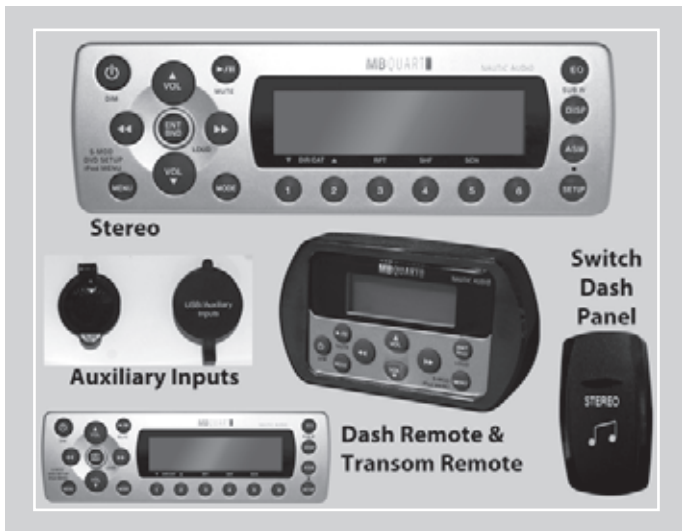

Please refer to your stereo owner's manual for proper operation instruction.

**NOTE:** Stereo unit is connected to the STEREO switch on the dash.

## ADJUSTING THE BOAT SPEED

1. The speed of the boat can be adjusted faster by pressing and holding the "+" side of the momentary rocker switch, which will increase the engine speed relative to the throttle position, therefore to go faster than the initial set point.
2. The speed of the boat can be adjusted slower by pressing and holding the "-" side of the momentary rocker switch, which will decrease the engine speed. The engine will decrease speed below the initial set point.

## DISENGAGING THE SYSTEM

1. The Digital Cruise System will disengage throttle control when the throttle is brought back below the current speed set position at that time. IF the engine speed has been changed using the "+" or "-" momentary rocker switch during operation, the latest speed position is the point where the cruise system will disengage throttle control once the throttle position is lower than that relative speed position. The system will reengage once the throttle position is advanced back above the last set speed position.
2. The system can be completely disengaged by turning the system "OFF" using the rocker switch. If this is done while the boat is at speed and the system is engaged, the throttle will have to be moved below the set speed position before it will completely disengage and allow the operator complete throttle control.

## DIGITAL CRUISE - ACTIVATING THE CRUISE SYSTEM



1. Accelerate the boat up to the desired cruising speed.
2. Engage the Digital Cruise System by moving the rocker switch from "OFF" to "SET". At this point the cruise system will take over throttle control and maintain the speed at which it was set. The small red LED light will come on to let the operator know that the system is engaged. The red LED light will remain on until the system is turned "OFF" using the rocker switch.
3. The system will not allow any more throttle input than the position of the throttle arm. Therefore, the throttle arm should be advanced completely after the initial engagement of the system to allow the system to maintain the set speed with different throttle positions required such as when the boat turns.

## OPTIONAL DIGITAL CRUISE PRO



See page 55 for detailed operating instructions for the optional Digital Cruise Pro.

# STANDARD MOOMBA PACKAGE

## NAVIGATION LIGHTS SWITCH

The Navigation Light switch supplies power to the Bow Light, the Stern Light and the Pole Light.

### Operation (Refer to Illustration Below):

When underway during night time operation, set the switch in the NAV position to activate all of the running lights.

When docked or at anchor, set the switch, in the ANC position to activate only the pole light.

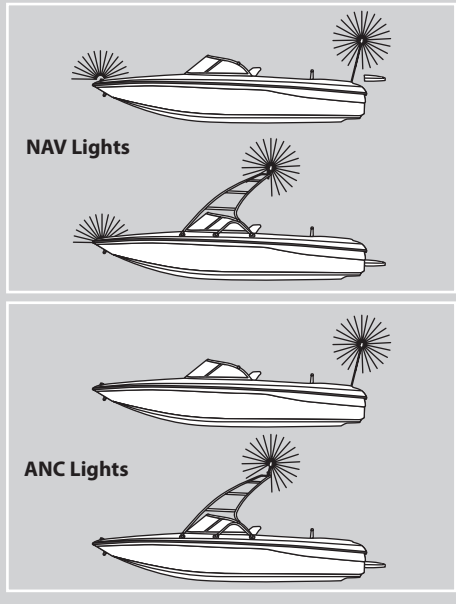

## COURTESY LIGHT SWITCH

The Courtesy switch supplies power to the lighting throughout the boat.

## BILGE PUMP SWITCH

The Bilge Pump switch operates in two positions. The manual position is used to verify that the pump is operational. The automatic pump function is engaged at all other times so that any excess water in the bilge may automatically be pumped out.

## STEREO SWITCH

The Stereo switch supplies power to the stereo unit. The switch must be turned on before the stereo can be played.

**NOTICE**  
If any lights, bilge, stereo, courtesy lights, or accessories fail to operate, press the appropriate circuit breaker located under the switch.

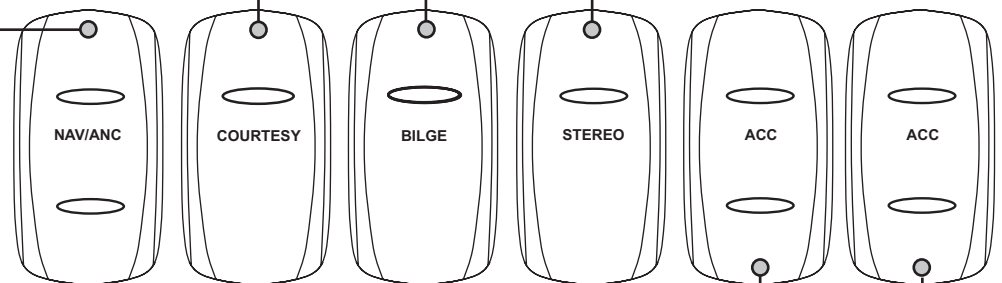

## ACCESSORY SWITCH (2 POSITIONS)

The Accessory switch supplies power to an extra circuit for accessories that may be added.

## ACCESSORY SWITCH (3 POSITIONS)

The Accessory switch supplies power to an extra circuit for accessories that may be added.

Switch configuration may vary slightly based on options. If you have any questions regarding operation, please contact your dealer or Skier's Choice, Inc.

## MOBIUS PACKAGE

### NAVIGATION LIGHTS SWITCH

The Navigation Light switch supplies power to the Bow Light, the Stern Light and the Pole Light.

#### Operation (Refer to Illustration Below):

When underway during night time operation, set the switch in the NAV position to activate all of the running lights.

When docked or at anchor, set the switch, in the ANC position to activate only the pole light.

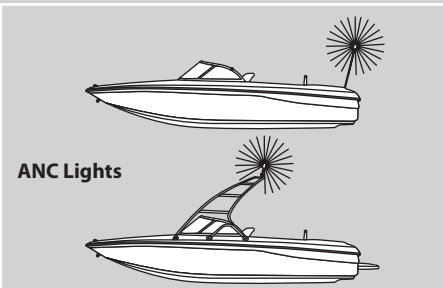
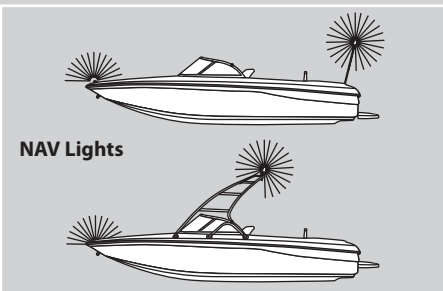

### COURTESY LIGHT SWITCH

The Courtesy switch supplies power to the lighting throughout the boat.

### BILGE PUMP SWITCH

The Bilge pump switch operates in two positions. The manual position is used to verify that the pump is operational.

The automatic pump function is engaged at all other times so that any excess water in the bilge may automatically be pumped out.

### STEREO SWITCH

The Stereo switch supplies power to the stereo unit. The switch must be turned on before the stereo can be played.

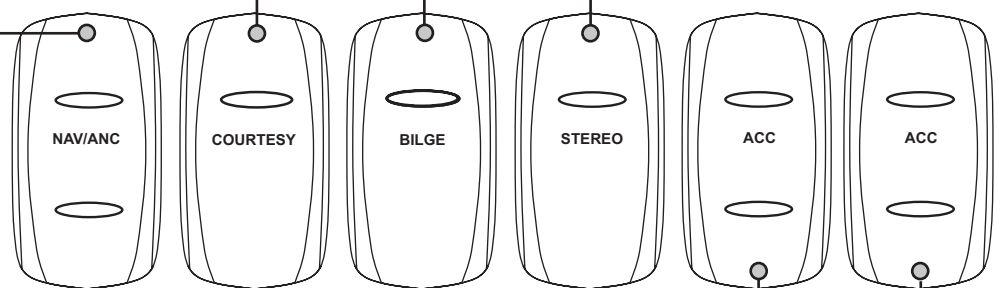

### NOTICE

If any lights, bilge, stereo, courtesy lights, or accessories fail to operate, press the appropriate circuit breaker located under the switch.

### ACCESSORY SWITCH (2 POSITIONS)

The Accessory switch supplies power to an extra circuit for accessories that may be added.

### ACCESSORY SWITCH (3 POSITIONS)

The Accessory switch supplies power to an extra circuit for accessories that may be added.

Switch configuration may vary slightly based on options. If you have any questions regarding operation, please contact your dealer or Skier's Choice, Inc.

## IGNITION SWITCH

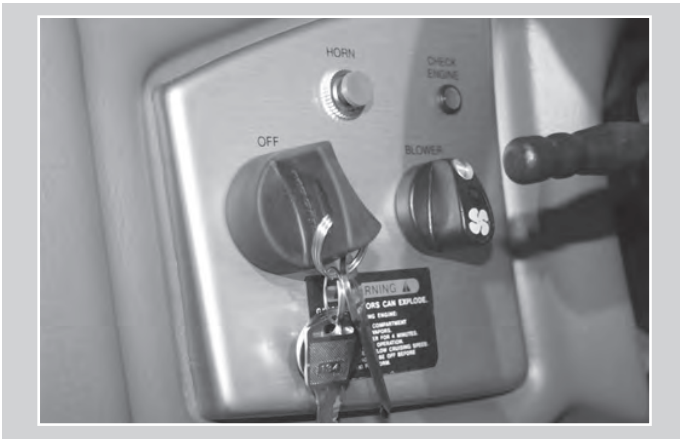

Located on the port side of the dashboard, the ignition switch has four positions. In the vertical position, the ignition is "OFF".

One position clockwise is the "ON" position and this will power the switches and energize the motor.

The full clockwise position is the "START" position.

**NOTE: All electrical equipment should be turned off when the boat is in storage.**

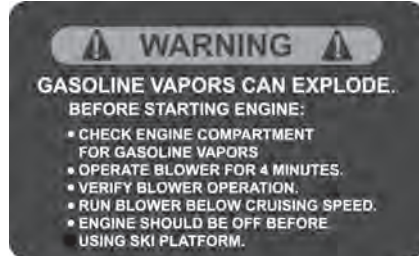

## HORN

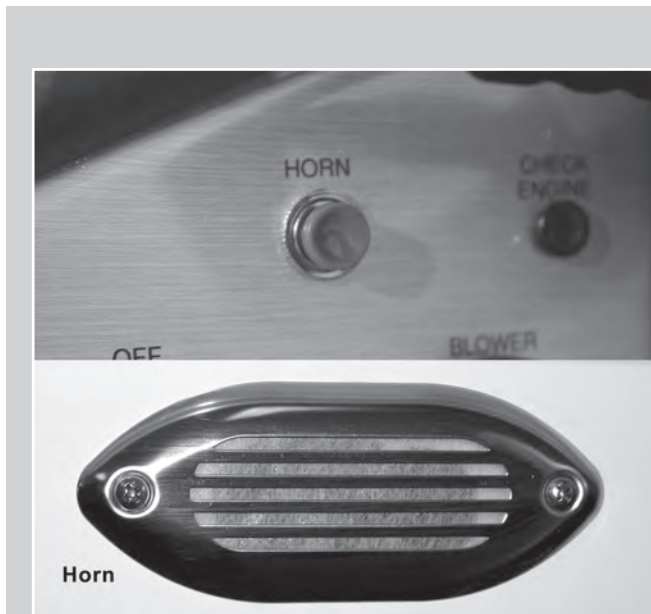

## TILT STEERING



Tilt steering may be adjusted up or down in five different locking positions. To adjust, depress the tilt lever located beneath the bezel and move the steering wheel to the desired position. Release the lever to lock the wheel into place.

The Horn Switch is located on the switch panel to the left of the steering wheel.

### Horn / Whistle Signals

#### One Long Blast:

*Warning Signal (Coming out of slip)*

#### One Short Blast:

*Pass on my Port Side*

#### Two Short Blasts:

*Pass on my Starboard Side*

#### Three Short Blasts:

*Engines in Reverse*

#### Four or More Blasts:

*Danger Signal*

1. **OVERTAKING / PASSING:** Boat being passed has the right-of-way. **KEEP CLEAR.**
2. **MEETING HEAD-ON:** *Keep to the right.*
3. **CROSSING:** Boat on the right has the right-of-way. *Slow down and permit him to pass.*

## WARNING LIGHT (V-DRIVES ONLY)



The warning light should be “on” at idle. If the light remains “on” when the engine is above 1200 RPM, shut the engine off and check V-Drive oil level.

## CHECK ENGINE LIGHT

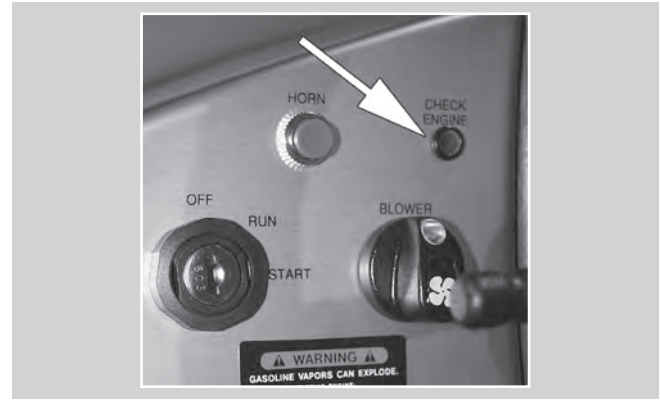

Your boat has a red check engine light. It functions much the same as the check engine light in your car. If the engine control module senses certain engine parameters out of range or a trouble code is set, the light will come on.

If the light does come on, stop using the boat and see an authorized Indmar or Skier's Choice Service Center.

## SAFETY LANYARD/ENGINE SHUT-OFF SWITCH

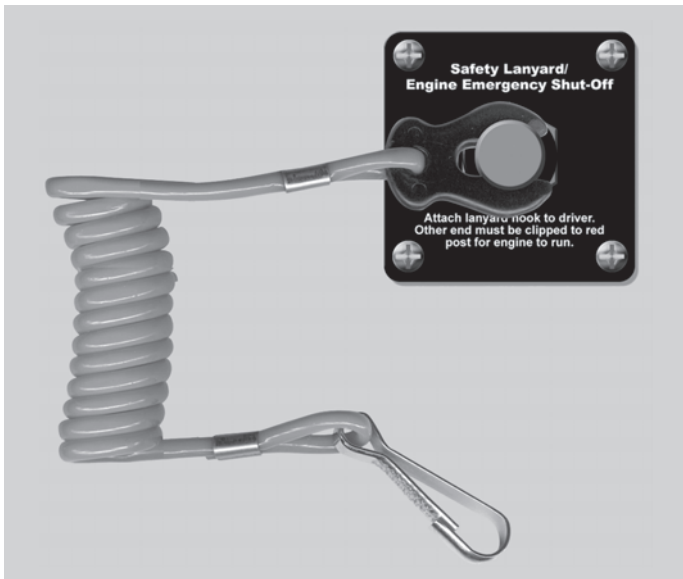

Your Moomba is equipped with a Safety Lanyard/Engine Shut-Off switch. In order for the engine to run, the plastic tip of the safety lanyard must be attached to the switch. If the clip is removed from the switch, the engine will not run.

### **⚠ WARNING**

**Avoid serious injury or death. Attach Safety Lanyard to driver prior to operating the boat.**

## GRAVITY BALLAST SYSTEM

### 2 VERSIONS — GRAVITY 1 AND GRAVITY 3

The optional Gravity Ballast System is an electronically controlled ballast system that can be operated from the driver's seat. The Gravity System is available in a 1 or 3 position system. The switch panel to the 3 position system is located directly below the shifter mechanism, and the 1 position system is operated from a switch on the dash. Each switch allows independent filling and draining of each ballast container by simply hitting the fill or drain switch. If the system fails to fill or drain, you may check the resettable breaker on the switch panel, or the separate ballast fuse block located under the dash area. The ballast bags or tanks can be found in the front ski locker, under the rear seat, or in the rear v-drive storage areas depending on the the model and ballast system.



Care should be taken that the ballast bags are situated properly with the fill hose on top and drain hose on bottom and that all fittings are installed securely. The bags should not be twisted and the bags should be free to expand and drain completely. Care should be taken to prevent sharp objects from coming in contact with the bags. Cuts and punctures to the bags are not warrantable.



Each Gravity Ballast System also includes a manual shut off valve in case of emergencies. If closed, the valve will prevent any water from entering the system and is only used in emergency situations. Under normal use the valve should remain open to allow full flow of water into the system.

#### Gravity I - 1 Position System Priming the System

To allow water into the system, the Gravity 1 Ballast System utilizes a scooped intake strainer to force water into the system. This allows the ballast system to be filled while running or sitting still. If air becomes trapped in the system, it may be necessary to run the boat at planing speeds to force water into the system and allows the fill pump to prime fully. Once the pump has primed it is no longer necessary to run the boat for filling. This situation may occur if the boat is trailered.

#### CAUTION

When bags begin to vent, shut off!

#### WARNING

DO NOT OVERFILL BALLAST BAGS!

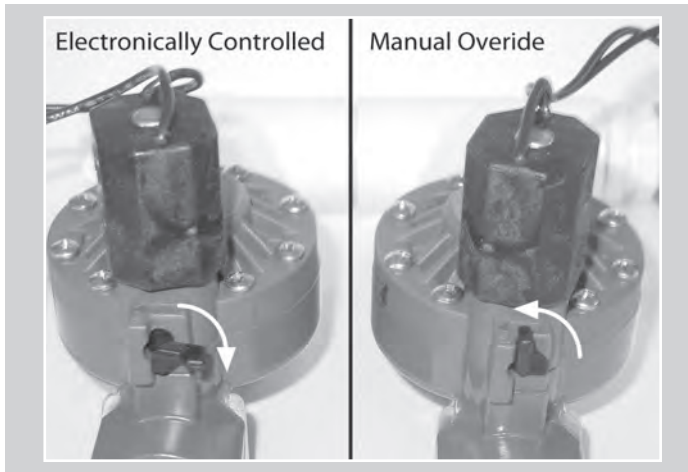

The Gravity 1 Ballast System utilizes a manifold and a solenoid valve to independently fill each bag or tank. The solenoid valves have a small toggle switch that can manually override the opening of the valve. The manual toggle switch needs to be in the “down” position to allow the system to be controlled by the switches in the dash area. If the manual toggle switch is turned to the “up” position, the valve will be open all the time and cannot be controlled by switches in the dash area. If the ballast system fills continuously while running the boat, check to make sure the manual override toggle switch is in the “down” position. If it continues to fill and the manual toggle switch is in the “down” position, check for debris that may have clogged the solenoid valve forcing the valve to stay open. If the valves continue to fill, closing the manual emergency shut-off valve will prevent any water from entering the system.

Each Gravity Ballast System also includes an in-line water strainer before the manifold. This strainer will keep debris out of the solenoid valve and should prevent the valve from getting clogged up and forced open. The strainer cover should be removed periodically and the filter screen cleaned to prevent debris buildup on the mesh screen. Be careful when removing the cover not to lose the O-ring used to seal the cover. Also, the strainer should be removed and drained during winterization.

To fill the ballast system, press the fill switch. To empty, press the empty switch. With the ballast full, the boat may porpoise at speeds above 25 mph.

**⚠ WARNING**

**Empty ballast before trailering the boat. DO NOT trailer boat with ballast full!**

**OUTBACK OPTIONAL GRAVITY BALLAST SYSTEM**

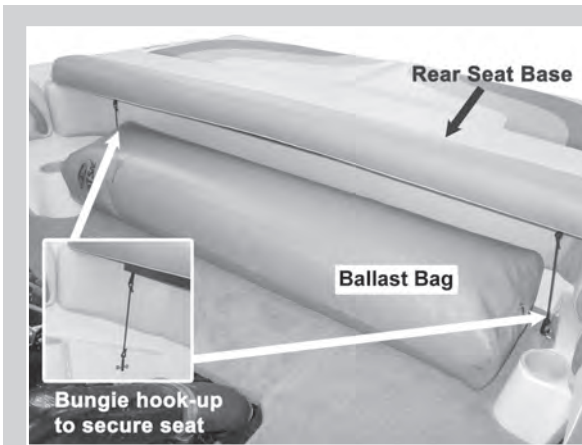

**NOTE: When filling the rear ballast bag in the Outback, the rear seat should be raised to the upper position to allow the bag to expand freely.**



## GRAVITY 3 BALLAST SYSTEM



The Gravity Ballast System in your boat is an electronically controlled ballast system that can be operated from the driver's seat. The manual switches for this three position system are located in the switch panel directly below the shifter mechanism.

The Ballast System in your boat is an integrated and logically controlled system. At the heart of the system is a series of reversible pumps that use impellers to pump water in and out of the ballast system. The controller for the system runs the pumps an appropriate amount of time to fill and to empty the bags.

**Filling the System**-In normal operation of the system, flipping one of the switches to "Fill" will start the system filling the associated ballast. The pump will automatically turn off when the appropriate amount of time to fill the system has been reached. The light on the switch will still be luminated as it is in the "Fill" position, but the pump will not be running. The switch should be turned back to the "off" position when the pump stops running.

**Emptying the System**-In normal operation of the system, flipping one of the switches to "Empty" will start the system emptying the associated ballast. The pump will automatically turn off when the appropriate amount of time to empty the system has been reached. The Light on the switch will still be luminated as it is in the "Empty" position, but the pump will not be running. The switch should be turned back to the "off" position when the pump stops running.

**Ballast Pump Impellers**- The pumps that fill and drain the ballast system use an impeller. Your Moomba ballast impeller uses the latest polymer technology in an effort to have the longest service life possible. The impellers are a wear item and different use patterns, water types, debris, etc. can greatly affect the service length of the impeller. As the impellers wear, the amount of water that is pumped into and out of the ballast system is reduced. Running the pumps without water will greatly accelerate the wear and prolonged running of the pumps without water will damage the impeller to the point that they will require immediate replacement.

Note: Impellers are a wear item and not covered by warranty.

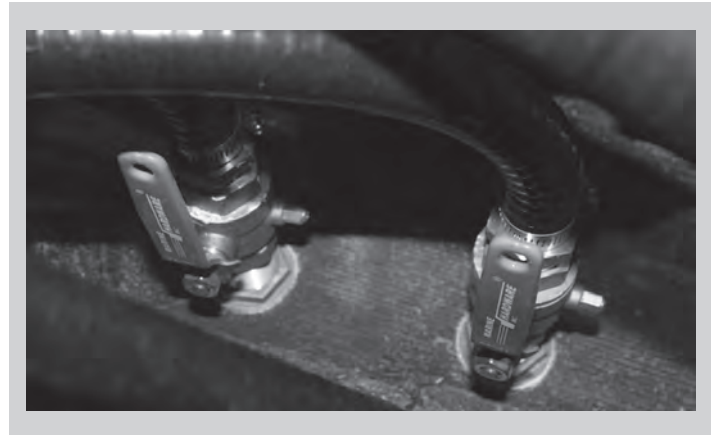

### 2011 Moomba Ballast Fill Times

Boat Model	Front Ballast	Rear Ballast Time
Outback V	3 minutes	4.5 minutes
Mobius LSV	3 minutes	4.5 minutes
Mobius XLV	4 minutes	4.5 minutes

**CAUTION** When bags begin to vent, shut off!

**WARNING** Do Not overfill ballast bags!

**2011 Ballast Trouble Shooting Guide**

**Ballast Switch LED Light Blink Codes**

<b>Blink Code</b>	<b>Cause</b>	<b>Reason</b>	<b>Correction</b>
One Blink	Pump has run dry	Tanks empty or no water at inlet	Pump will shut down in approx. 15 seconds and will not restart until switch is cycled off.
Two Blinks	High Amperage draw from pump	(1) Line blocked, pump stalled  (2) Low battery voltage  (3) Turning on all the pumps at the same time.	(1) Pump will shut down immediately and not restart until switch is cycled to off. If problem persists, unit will shut down immediately again until problem is resolved.  (2) Check the battery voltage. Have engine running when turning on the pumps.  (3) Turn the pumps on one at a time.
Three Blinks	Power loss between the module and the pump	Open condition, winding breaks, power removed between control module and pump.	Module will shut down after 10 seconds of loss of power between module and pump and will not restart until cycled.
Four Blinks	Low voltage	Pump will not start if power at control module is less than 10.5 VDC	Charge battery and/or run boat engine while filling ballast.
Six Blinks	Timer limit	Programmed limit	Control module has reached programmed or maximum run time. Additional ballast can be added (bumped) in 1 minute increments by pressing FILL. This will add extra water to ballast but will not effect program time.

<b>Problem</b>	<b>Possible Cause</b>	<b>Action</b>	<b>Correction</b>
Pump will not turn on, no blinking light at switch	Ballast power wires not connected to battery	Check ballast power wires at battery	Connect power wires to battery
Pump will not turn on, no blinking light at switch	Ballast breaker is tripped	Check 60 amp ballast breaker at the battery	Reset ballast breaker at battery
Pump will not turn on, no blinking light at switch	System needs reset	Check power to all areas	Turn power off to the system at the breaker and then back on and retry
Pump turns on, but does not pump water	Pump not priming	(1) Water intake ball valves are not open  (2) Kink in hose	(1) Open ball valves  (2) Check hoses for kinks and straighten as needed  (3) Check hose connections and tighten if loose.

**IGNITION KEYS**



Two ignition keys are provided with the boat. Key entry into the ignition may sometimes be difficult due to the rubber boot protector. Please do not unduly force the key into the ignition. Key tumblers are located vertically, so the key should be vertical when placed into the switch.

**NOTE: Ignition key blanks may be purchased through your Moomba dealer.**

**FUEL CAP**



**NOTE: The gas cap is sealed by a rubber O-ring. Please do not over tighten.**

**MIRRORS**

Windshield Mounted Mirror



The rear view mirror is installed as a standard item. The mirror is adjustable so that it may be set for each driver.

- Mirror should always be checked before driving.
- Mirror angle will change with each new driver.

Tower Mounted Mirror



## DRIVER'S SEAT & SEAT ADJUSTMENT

The Rise-R Seat is a unique driver seat enhancement. The front edge of the driver's seat cushion lifts up to give the driver a taller sightline. To switch the seat to the raised position, use two hands to lift and push the front edge of the seat cushion up and back until it is sitting on the rear half of the driver's seat cushion. To switch to the lower position, use two hands to push the Rise-R seat cushion forward and down.



### **⚠ CAUTION**

Be careful of the articulating hinge. Do not place fingers or other objects in the hinge mechanism during use.

The driver's seat may be adjusted forward or backward by moving the lever below the front of the seat. Use body pressure to move the seat to the desired position. Release the lever then check to feel the seat lock into place.

### **⚠ CAUTION**

After adjusting the seat, be sure that it has locked into place by pushing forward and backward until it has securely latched.

**DO NOT attempt to adjust the driver's seat while the boat is moving.**

## MOTOR BOX COVER



The motor box encloses the inboard engine and quiets engine noise. When opening, stand on either side, grasp the handle and pull up and back at an angle. If the engine requires maintenance, open the box lid until it rests open.

### **⚠ WARNING**

Never open the Motor Box while the boat is moving!

### **⚠ CAUTION**

Some Moomba models DO NOT have mechanical devices to hold the motor box cover in the open position. Please use caution to prevent accidental closing.

## V-DRIVE ENGINE COMPARTMENT

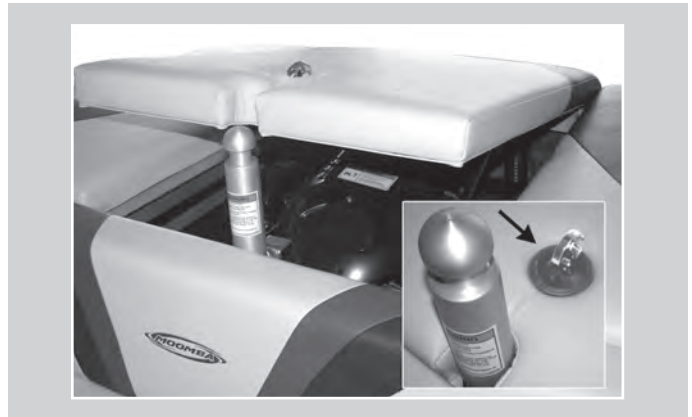

To access the engine compartment, turn latch and pull to raise the center sun deck lid. When the ski lockers and engine compartment lids are closed, the upholstered lids double as a cushioned sun deck.



**Pulley & Belt Warning!**  
Pulleys and belts can cause severe injury! Never open the motor box while the engine is running or while the boat is underway!  
Remember, after running, the engine is extremely hot and should not be touched or repaired until it has cooled.

## FIRE EXTINGUISHER



A standard Coast Guard approved fire extinguisher is provided on all Moomba boats. The fire extinguisher is located on the port side of the interior under the observer's seat.

(Refer to label instructions for use.)

## GLOVE BOX



To open the glove box, press the black round cylinder down while lifting the black finger tab. Once open, the lid is supported by a spring.

## SKI PYLON

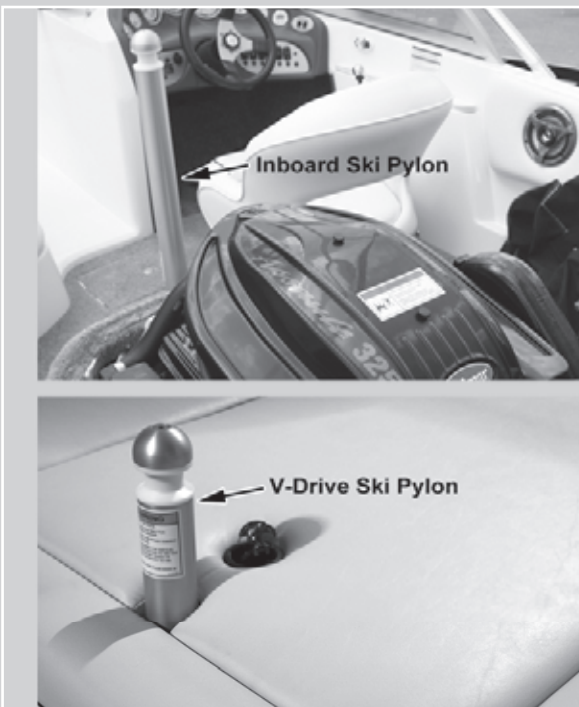

The ski pylon is only to be used to pull skiers. **DO NOT use the ski pylon to hoist the boat.** Only use the lifting rings for this purpose.

**NOTE:** With use the ski pylon may loosen. Should this occur, see your Moomba Dealer for service.

 **WARNING**

- AVOID SERIOUS INJURY OR DEATH.
- TOW PYLON SHOULD BE USED ONLY FOR TOWABLE WATER SPORTS DEVICES.
- DO NOT USE TOW PYLON FOR OTHER TOWABLE OBJECTS OR TOWING BOATS.
- TOW PYLON IS NOT DESIGNED FOR VERTICAL EXTENSIONS. ANY MODIFICATIONS TO THE TOW PYLON OR ITS MOUNTINGS MAY RESULT IN DAMAGE TO THE BOAT AND INJURY TO THE USER.
- DO NOT SIT BEHIND THE TOW PYLON WHEN IN USE.

WLSKP0803

### **WARNING**

The use of pylon extensions can severely effect the overall handling of the boat. Follow pylon extension manufacturer's directions for mounting.

**DO NOT** mount any Pylon Extension on the rear pylon (located at the rear sundeck).

## RAD-A-CAGE

The Moomba models are equipped with a Moomba Rad-A-Cage towing tower. The cage is designed as a stable tower to enhance wakeboarding. It is NOT intended to be used to tow skiers, barefooters, or multiple wakeboarders. Such use will void any warranties written or implied.

### **⚠️ WARNING**

Be sure that all bolts are tightly in place before use.

### **⚠️ WARNING**

Be aware of and avoid low overhead objects such as bridges, power lines, overhanging trees, etc.

### Style 1

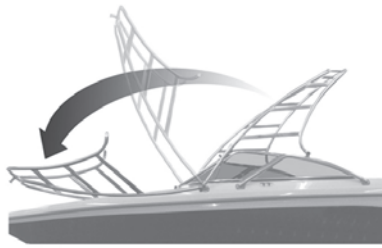

### Style 2

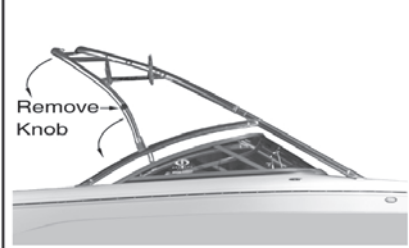

### STYLE 1

#### To LOWER CAGE FOR STORAGE:

Tools required: 5/16" Allen wrench (for stainless steel 3/8-16 X 1-14" Allen head bolt)

- Loosen, but DO NOT remove front leg allen bolts.
- Loosen and remove the hand-knob bolts that connect the rear legs to the feet.
- Place the hand-knob bolts somewhere for safe storage.
- While standing in the bow area, pull the cage forward, gently placing it against the bow of the boat.

### **⚠️ CAUTION**

Place padding between the cage and the boat to protect the gel coat.

#### To RAISE CAGE:

- Lift and rock the tower back into place until the rear legs align with the rear feet. (Some manipulation of the cage may be required to get the legs to line up with the feet.)
- Install and tighten the rear head-knob bolts
- Tighten the front leg's allen bolts.

### **⚠️ CAUTION**

The threads in the aluminum foot could be damaged if the bolts are not aligned and threaded correctly.

### **⚠️ WARNING**

The Rad-A-Cage is designed to pull a single (1) wakeboarder, trick skier, or kneeboarder.

### STYLE 2

#### To LOWER CAGE FOR STORAGE:

- Remove the four hand knobs from the top of the rear leg. While holding the tower up, lower the side legs. Then lower the tower downward into the boat.

#### To RAISE CAGE:

- Lift the tower and swing up the rear legs. Install the four hand knobs.

### **⚠️ CAUTION**

The threads in the aluminum foot could be damaged if the bolts are not aligned and threaded correctly.

### **⚠️ WARNING**

The Rad-A-Cage is designed to pull a single (1) wakeboarder, trick skier, or kneeboarder.

**NOTE: Apply a thin coat of anti-seize to the threads of the hand knobs periodically.**

### V2 TOWER

To lower the V2 tower, twist the release handle until the white dot is facing up. Pull the locking pin out. Repeat on other side. Guide the tower lower. The tower mechanism does have mechanical spring assist system to help minimize the effort required to lower the tower.

To raise the V2 tower, guide the tower into the upright position. Install the locking pin with the white dot up. Push the locking pin all the way into the tower and then rotate the handle so the white dot is facing down. Repeat on other side. The tower mechanism does have mechanical spring assist system to help minimize the effort required to raise the tower.

Warning: Do not operate the boat without the locking pins properly installed



## BOW LIGHT

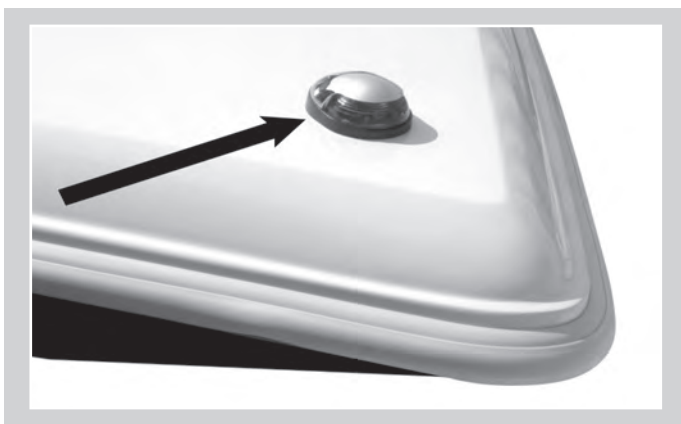

The bow light is located on the forward deck. To alert other boaters to your position and direction while underway at night, the light is green on the starboard side and red on the port side. To replace the bulb, remove Phillips screw to lift cover.

## TOWER POLE LIGHT

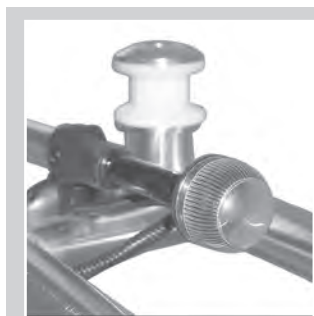

On boats equipped with factory installed towers, the 360° White Pole Light is mounted on the tower. To raise the light, pull the lever on the side of the light and then carefully raise the light to a vertical position. Always lower the light after use and before trailering to avoid hitting low overhangs.

**NOTE: If using tower pole light, do not use stern pole light.**



## STERN POLE LIGHT



The removable pole light is stored in the bow. Always check for proper alignment when inserting the pole light into the receptacle.

The pole light must always be in place and illuminated when visibility is limited. The pole light must be displayed while under way from sunset to sunrise. The pole light must also be illuminated while at anchor from sunset to sunrise.

**NOTE: Boats that are equipped with factory installed towers do not have a stern light pole even though the rear light receptacle is installed. If you would like a rear 360 pole light so you may operate your boat after dark with the tower removed, you may purchase one through your dealer.**

### **⚠ CAUTION**

**DO NOT pull skier with tow rope attached to ski pylon while pole light is in place.**

## POP-UP CLEAT

To use the cleat, pull center up.

### **⚠ WARNING**

**DO NOT tow objects with the cleats.**



## POLE LIGHT RECEPTACLE



The pole light receptacle is located on the port side deck near the stern. To install the pole light, open the cover completely and with the plug correctly aligned, slide it into the socket until the electrical contacts are firmly in place.

## BOW EYE



The bow eye is located at the front of the hull below the rub rail. It is the point of attachment to lead the boat onto the trailer and to secure the boat to the trailer or to a tie-off when docking.

**NOTE: See Hoisting Instructions before using the bow eye to hoist the boat.**

### **⚠ WARNING**

**DO NOT use the bow eye ONLY to hoist the boat. You must use a sling with the bow eye when hoisting the boat. Use only the designated lifting rings to hoist the boat. (See Hoisting Instructions.)**

## LIFTING RINGS



Two lifting rings are located on the transom.

**NOTE: The lifting rings should be the only point of attachment for lifting cables. (See Hoisting Instructions.)**

## SKI PLATFORM



All Moomba models are equipped with a ski platform on the stern. The platform allows easy access to and from the water for skiers and swimmers.

It is recommended that all entries to and exits from the water be made from the platform to avoid accidents. (The fiberglass deck can become slippery when wet.)

### **⚠ DANGER**

**Shut Engine OFF when people are on the platform or in the water near the platform.**

### **⚠ DANGER**

**Exhaust fumes contain carbon monoxide. Direct or prolonged exposure to carbon monoxide will cause brain damage or death.**

## SKI PLATFORM DETACHABLE BRACKET

The ski platform is fastened to the boat with detachable brackets. The platform may be removed from the boat by pulling the retaining pins from the brackets.

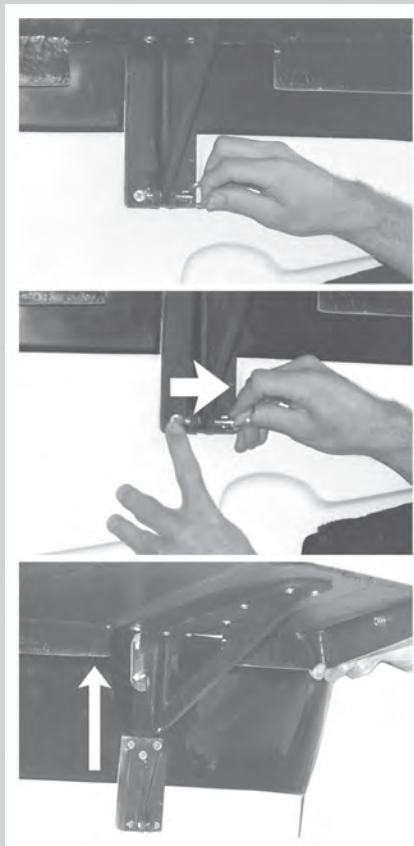



## PROPELLER

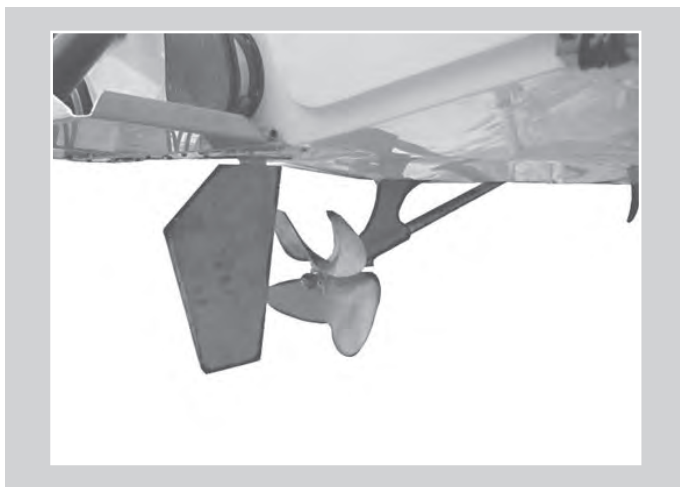

The research and design team at Skier's Choice has carefully explored and tested many different propellers and pitch angles for use on Moomba boats. All tests indicate that the current propeller installed on your model is the best for the variety of boating performance required, whether skiing competitively or for pleasure.

It is strongly recommended that your Moomba dealer be notified before changing the propeller. In general, changing to a lower pitched propeller may increase acceleration, but will decrease top speed. Changing to a higher pitched propeller may achieve higher top speed with a light load, while acceleration and power may decrease.

## PROPELLER PRECAUTION



### **⚠ WARNING**

**Moving propeller will cause injury. Propeller may rotate with boat in neutral. Shut off the engine when people are on the platform or in the water near the platform to avoid injury from the prop rotation.**

**NOTE: Under no circumstances should a propeller which allows the engine to surpass recommended RPMs be installed.**

### **⚠ CAUTION**

**Avoid engine damage, do not exceed the Max RPM as listed for your motor. Some props may allow the engine to over-rev which can cause non-warrantable engine damage.**

## OUTBACK CONVERTIBLE REAR SEAT/SUNDECK

The Outback features a convertible rear seat that can be placed in normal seat cushion setting (A) or in an upper sundeck setting (B). To move the seat from the low to high position, pull the seat cushion forward toward the motor box, then place the cushion on top of the rear seat sides. Be sure to install the locking straps (C) when the cushion is in the upper position.

### **⚠ WARNING**

**DO NOT exceed 45 MPH with the sundeck in the upper position. DO NOT trailer the boat with cushion in the upper position. Loss of a seat cushion or damage associated to the seat coming out of the boat IS NOT covered by your boat warranty.**

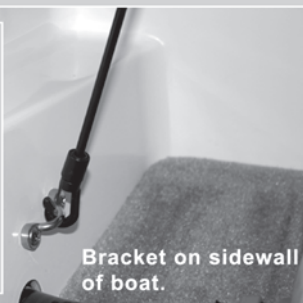
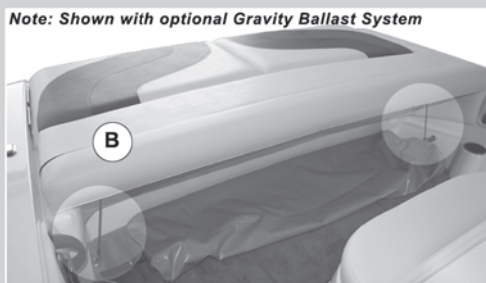
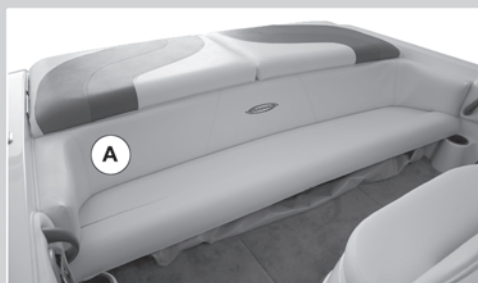

Bracket on bottom of seat cushion.

C  
Locking Straps

Bracket on sidewall of boat.

## OPTIONAL TRIM SWITCH AND GAUGE

## WAKEPLATE



This switch controls the optional wakeplate. The gauge indicates the position of the wakeplate.

The optional wakeplate allows the driver to control the running attitude of the boat.

## BATTERY BOX



The battery box is mounted on the inside of the observer's seat storage compartment.

**NOTE:** It is recommended that the battery cables be disconnected from the battery when the boat is placed in storage. (Refer to Battery Cable Installation and Precautions)

### **⚠ CAUTION**

Avoid damage or injury from battery acid. Ensure that battery is properly secured before using the boat.

## FUELING CONDITIONS



The following conditions may be considered normal operation of the fuel gauge and fuel system:

- Gas station pumps may shut off before the fuel gauge indicates **FULL**.
- The amount of fuel required for fill-up may not exactly correspond to the gauge.
- The gauge needle may not move away from **FULL** until some time after fill-up.
- The gauge needle may move during turns, stops, and acceleration.

**NOTE: Become familiar with engine hourly fuel consumption at various speeds and know when to check the fuel gauge.**

## WALK-THROUGH WINDSHIELD

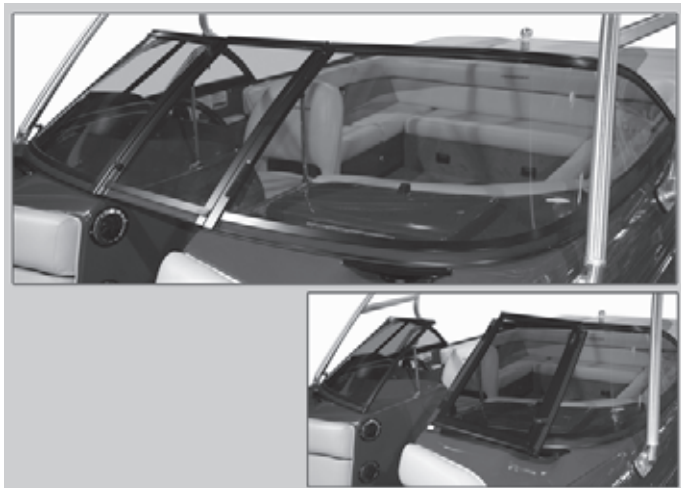

The moveable center windshield panel allows access to and from the bow area on some models. To open, turn safety latches to vertical and push. Carefully lay the hinged windshield panel back against the fixed side panel.

## FUEL VENT

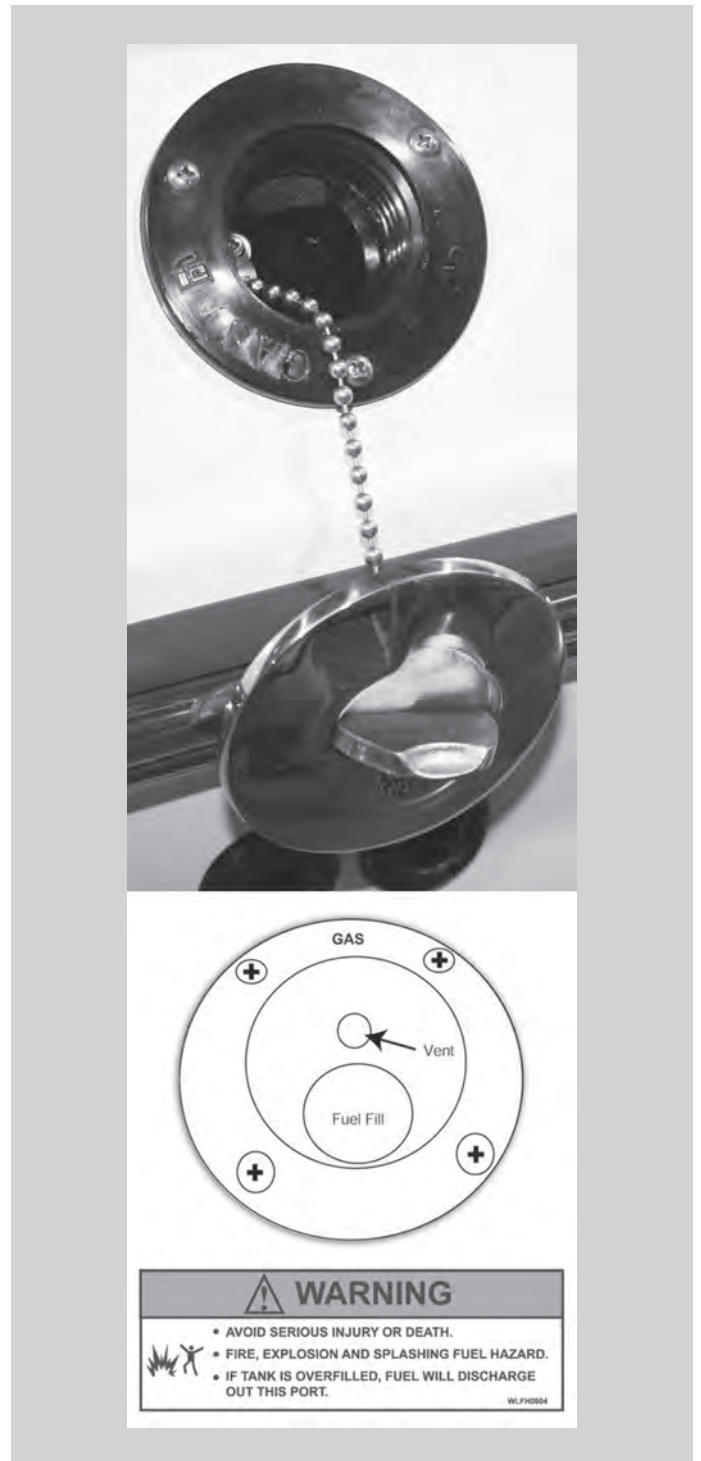

The fuel vent is a part of the gas filler neck. This vent is connected to the fuel tank via the vent hose, which releases gasoline fumes from the fuel tank.

**⚠ DANGER**

**Gasoline vapors are highly explosive!**

## FUEL TANK PUMP



Your boat contains a fuel system that is designed using current fuel delivery technology. The common terminology for this type of system is: Pump in Tank.

The system consists of a dual high pressure pump canister that is mounted inside the fuel tank. On the top of the canister there is a fuel pressure regulator. The engine's fuel lines are connected to the in tank fuel pump via a specially designed shielded, flexible high pressure fuel hose. This hose is pressurized. This system requires special tools and knowledge to service and maintain and as such is not owner serviceable.

The fuel filter for the boat's fuel delivery system is in the fuel tank. This style filter system is considered a lifetime filter under normal circumstances.

The pump in tank fuel delivery system uses the fuel to lubricate and cool the fuel pumps. Running the pumps with very low fuel levels or running the pumps without fuel in the tank can induce air into the pumps which may shorten the fuel pump's longevity. This type of fuel pump damage is not warrantable.

Outback pump is located in the rear ski locker beneath the removable cover. The pump may be accessed by twisting and removing the access cover.



On all V-Drive models, the fuel pump is located beneath the floor in front of the rear seat. The pump may be accessed by twisting and removing the access cover.

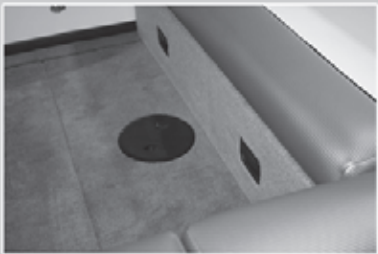

## THE FOLLOWING USCG INFORMATION IS IMPORTANT TO YOUR SAFETY AND SAFE OPERATION OF THE BOAT:

"THIS BOAT COMPLIES WITH U.S. COAST GUARD SAFETY STANDARDS IN EFFECT ON THE DATE OF CERTIFICATION WITH THE EXCEPTION OF CERTAIN FUEL SYSTEM REQUIREMENTS ASSOCIATED WITH ITS FUEL INJECTED ENGINE AS AUTHORIZED BY U.S. COAST GUARD GRANT OF EXEMPTION (CGB 09-003). MAINTENANCE OF THE FUEL SYSTEM IN THIS BOAT SHOULD BE PERFORMED ONLY BY EXPERIENCED TECHNICIANS USING IDENTICAL FUEL SYSTEM COMPONENTS."

"SERVICE OF THE ENGINE INSTALLED IN THIS BOAT REQUIRES SPECIAL TOOLS, TRAINING AND GENUINE REPLACEMENT PARTS WHICH ARE ONLY AVAILABLE FROM SKIER'S CHOICE, INC. THE FUEL SYSTEM SHOULD BE SERVICED ONLY BY A SKIER'S CHOICE TRAINED CERTIFIED TECHNICIAN. DO NOT ATTEMPT TO SERVICE THE SYSTEM YOURSELF."

## DOUBLE-UP SEATING



Some Moomba models offer Double-Up Seating. This unique seating can be stored flat for easy access to the bow or flipped up for extra rear and forward facing seating. To use this seating, lift and pull the seat back into the locked position. Be sure that the metal arms are locked before applying pressure.

To lay seat back down, simply pull the seat section of the backrest more upright to release the locking mechanism.

## OPTIONAL SWIVEL AND NON-SWIVEL WAKEBOARD RACKS

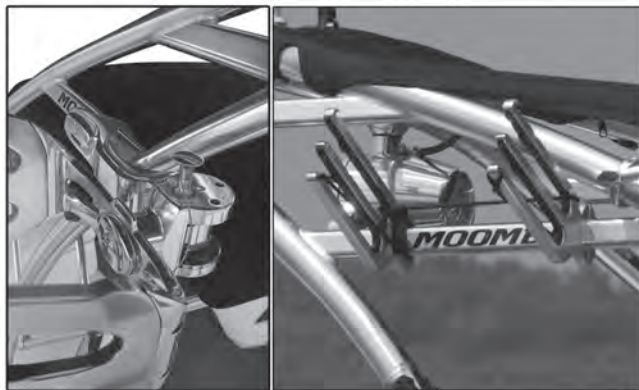

Wakeboard racks are a convenient way to transport and store wakeboards while using your boat.

### **⚠ CAUTION**

Check tightness of all mounting hardware before each use.

### **⚠ CAUTION**

DO NOT trailer the boat with wakeboards mounted in the rack.

## OPTIONAL BIMINI TOP STYLES



Z5 Cargo Rack



Forward Bimini

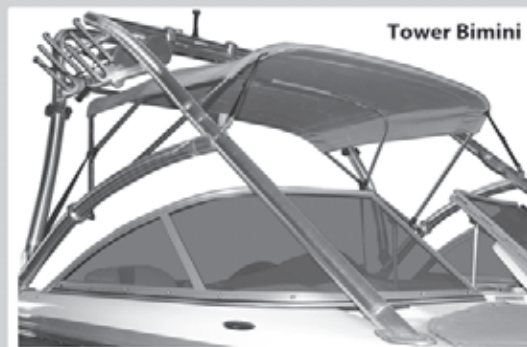

Tower Bimini

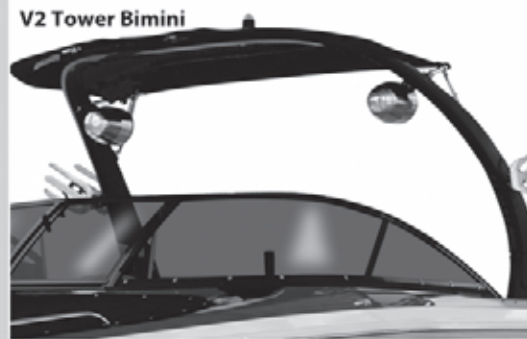

The bimini top is designed as a sunshade. Please see the mooring cover section for instructions on cleaning and caring for your bimini top. When opening and latching the straps to the eye hooks, twist the strap one to two times to prevent them from vibrating in the wind.

### **⚠ CAUTION**

DO NOT tow the boat above 45 MPH with the bimini top open or the Z5 canvas on the frame. Damage to the canvas may occur. This type of damage is not warrantable.

## COURTESY LIGHTS



Courtesy lights are installed at several locations in the interior of the boat. The courtesy light switch is located on the instrument panel and is marked "**COURT**".

## COOLER



Some Moomba models offer built-in coolers. They are foam insulated and have drain holes that drain water into the bilge. Be sure to thoroughly clean the cooler and allow it to dry after each use to prevent mold and mildew.

**NOTE: Damage from mildew and mold IS NOT covered under your boat warranty.**

## OPTIONAL SATELLITE RADIO



The optional satellite radio option is designed to give the user music access anywhere they go in North America. The system is a 100 channel system which is broken down into different music types such as: oldies, hard rock, easy listening, alternative, 80's, jazz, big bands, etc. This system does have a minimal subscription fee that must be paid annually to continue service. Please see satellite radio owner's manual for more information.

**NOTE: Location of satellite antenna may vary.**

## OPTIONAL DIGITAL CRUISE PRO



Digital Cruise Pro combines an LCD display and push-button inputs into a Cruise Control user interface, which is dash-mounted in the boat. Its primary function is to provide the driver with digital readouts of actual and desired boat speed, and to allow the driver to modify the desired speed using the push-buttons. Cruise control can be turned On and Off, and a water temperature display is also provided.

Digital Cruise Pro uses boat speed information provided by a paddlewheel speed sensor, and has provision for calibrating the accuracy of the paddlewheel signal if the user has an independent measure of actual boat speed available, such as a hand-held GPS device. Digital Cruise Pro can optionally be upgraded to ZeroOff GPS Cruise which uses GPS based speed feedback for improved performance and overall accuracy.

Working together with the electronic engine control module (ECM), Digital Cruise Pro provides true closed loop control of boat speed. As long as the boat motor has enough power, the boat automatically tracks the desired speed.

### The Digital Cruise Pro faceplate includes the following:

- A 128/64 pixel backlit LCD display
- MENU button
- ON/OFF button
- UP button
- DOWN button

### Using the Faceplate Buttons

Use the four buttons, MENU, ON/OFF, and the UP and DOWN arrow keys to navigate through menu options and modify parameters. Buttons may be either tapped or held, depending on the function being invoked. For functions where a button hold is appropriate, the button should be held ON for 2 seconds or so, and a double beep will be heard acknowledging the hold action. For taps, a single beep acknowledgement is heard.

## Quick Start Information

The normal "CRUISE" screen displays the following items:

- An ON/OFF icon in the upper left corner
- Actual boat speed in the upper center portion of the screen
- Target boat speed in the bottom center of the screen (slightly smaller font) with an indicator to the left showing whether paddlewheel (PW) or GPS feedback is in effect
- Water temperature in the lower right corner

To operate the boat under manual control, tap the ON/OFF button so that the ON/OFF icon indicates "OFF". This will disable the cruise control and the driver will have full control of boat behavior using the throttle lever. If the system is turned OFF while the boat is under cruise control, the throttle lever must be pulled back close to idle to regain manual throttle control.

To enable cruise, tap the ON/OFF button so that the ON/OFF icon indicates "ON". The driver can then advance the throttle lever beyond the point required to allow the boat to reach the current target speed. The boat will approach the target speed as quickly as engine power and boat loading will permit, and then settle quickly at and maintain the target speed as long as the throttle lever remains sufficiently advanced. Throttle lever position always sets a limit to what percentage of engine output is available, and the driver can slow the boat at any time by simply pulling back the throttle lever. If the engine output required to maintain speed increases, for instance in a turn, the driver may need to advance the throttle further to allow full engine power to be applied.

To change the speed set point, tap or hold the UP/DOWN buttons. Single taps will increase/decrease the set point by 0.1mph increments (0.2kph if metric units are selected) for fine adjustments. Holding the UP/DOWN buttons results in changing the set point at a rate that increases the longer the button is held. The speed set point can be varied between 5 and 60 mph.

### Using Digital Cruise Pro

Digital Cruise Pro automatically starts when the boat's ignition switch is turned ON. It starts in the same configuration in which it was turned off, provided the battery was not disconnected. This means the same configuration settings for boat speed and setup selections are retained for the next operating session, provided the battery was not disconnected. If the battery was disconnected, Digital Cruise Pro starts in a default mode.

While bringing the boat up to speed to the point where the Digital Cruise Pro speed control engages, you can manipulate the throttle as desired if pulling a skier up. Digital Cruise Pro beeps to acknowledge the point of engagement. Once the boat has achieved the target speed, move the throttle handle all the way forward to ensure load variations won't result in loss of speed regulation. A wide-open throttle handle position frees up the engine to produce its maximum torque output and allows the speed control to operate at its optimum level.

**NOTE:** If the system has been reconfigured as a ZeroOff GPS Cruise, a satisfactory GPS fix is required to operate in speed control mode, which usually occurs within 5-10 seconds after turning on the ignition.

## Digital Cruise Pro Screens

Digital Cruise Pro provides two screens, a CRUISE screen for normal use and a DIAGNOSTICS screen for viewing system information and trouble codes.

### CRUISE Screen

Details of how to use this screen are listed earlier in the "Quick Start Information" section. If the system has been reconfigured as a ZeroOff GPS Cruise, an additional feature appears on this screen when "River Mode" is turned ON. Two additional parameters appear in the center of the screen, which can be highlighted by tapping the MENU button:

- DNStream/UPStream: When highlighted, this parameter can be toggled using the UP/DOWN buttons. When in UPStream mode, the value to the right is subtracted from the base speed set point to compensate for the additional speed over water caused by traveling against the current. Conversely, when in DNStream mode, the value to the right is added to the base speed set point to compensate for the loss of speed over water caused by traveling with the current.
- Speed Offset: Appears to the right of the UPStream/DNStream icon. This number is an estimate of how fast the river current is flowing. It can be estimated by allowing the boat to float in the current and reading off the boat speed.
- The concept of operation is to highlight the Speed Offset and use the UP/DOWN buttons to enter an estimate of river current speed. Then move the highlight to the UP/DNStream icon and use the UP/DOWN buttons to switch modes while turning the boat to travel either upstream or downstream. This allows the driver to achieve reasonably consistent speed over the water while pulling a skier/wakeboarder by tapping the UP or DOWN buttons as appropriate during the turns.

### DIAGNOSTICS Screen

The Diagnostics screen provides part number information and also lists active and historical error codes. This information is useful for troubleshooting any problems, which may arise, as well as for providing information necessary for generating 10-digit codes if a field reconfiguration to ZeroOff GPS Cruise is required.

The unit's part number (P/N:) and serial number (S/N:) are displayed on the top line. The software revision level is shown on the second line (SW:), followed by an instruction on how to clear codes (tap the MENU button). The remainder of the screen displays Active (left column) and Historic (right column) trouble codes. The number of codes being stored is shown in each case (e.g. 01 Active 02 Historic), and a short line of text as listed below will appear in each column for each code being stored. Possible codes include:

Screen Text	Meaning
"H2O_maxv "	Water temp sensor Voltage too high
"H2O_minv "	Water temp sensor voltage too low
"V_max "	Battery supply Voltage too high (> 32 volts)
"V_min "	Battery supply Voltage too low (< 9.5 volts)
"VE5_max "	5V output supply too high (>5.4 volts)
"VE5_min "	5V output supply too low (>4.6 volts)
"COPfail "	Main CPU timeout failure, should be very rare
"RT11 "	Main CPU failure, should be very rare
"RT12 "	Main CPU failure, should be very rare
"RT13 "	Main CPU failure, should be very rare
"ADloss "	Main CPU failure, should be very rare
"interrupt "	Main CPU failure, should be very rare
"flash_fail "	Main CPU flash memory failure, should be very rare
"RAM_fail "	Main CPU RAM memory failure, should be very rare
"J1939_Txfai "	CAN link failure, CAN wires probably not connected

### Screen Text

"J1939\_Rxfai "

### Meaning

CAN link failure, power supply related or bad connections on CAN wires

"EE\_Write "

Onboard permanent memory write failure, indicates circuit board failure

"EE\_Read "

Onboard permanent memory read failure, indicates circuit board failure

Fault codes can be cleared by tapping the MENU button. If an active fault is still present, it will reappear after a short delay in both active and historic column. If the source of a fault is corrected (e.g. a disconnected water temperature sensor), the active code will clear automatically, but the historic code will remain until MENU is tapped. Note that if the battery is disconnected all stored codes will be lost.

**Note that when this screen has been selected, you can return to the CRUISE screen by tapping either the UP or DOWN buttons.**

### SPEED-RPM-GPS Screen

This screen is only available on units configured as a ZeroOff GPS Cruise. It provides additional functionality that is only possible if GPS antenna data is available. This screen allows the user to operate the boat in either boat speed control mode, or in an engine RPM control mode. Parameters displayed include (clockwise from top left):

- Time of day on left of top line
- Date following time of day
- Satellite fix status following date: X: No Fix, F: Non Differential Fix, D: Differential Fix. Either F or D Fix Status is acceptable for normal cruise performance
- Page Change icon following fix status, a small diamond: When highlighted, the UP/DOWN buttons can be used to change to the CRUISE page
- Compass arrow: If GPS satellite fix is available, this arrow shows compass direction of boat motion. If no fix is available, an "M" logo is displayed.
- Boat speed, largest font number on screen, followed by units indicator, either mph or kph
- Latitude and Longitude are shown on the bottom line in degrees and minutes
- Boat speed set point, with a vertical "Set" icon to the left. The "Set" icon is highlighted if cruise is ON in boat speed mode, otherwise not highlighted
- Engine RPM set point, with a vertical "Set" icon to the left. The "Set" icon is highlighted if cruise is ON in Engine RPM mode, otherwise not highlighted
- Engine RPM, to the right of the RPM set point parameter.

This screen allows three parameters to be modified with the UP/DOWN buttons. A highlight block can be moved amongst the three parameters by tapping the MENU button. The UP/DOWN buttons will operate on whichever of the three parameters is highlighted:

- Boat speed set point: UP/DOWN buttons function as they do on the CRUISE page
- Engine RPM set point: UP/DOWN buttons function similarly to speed set point
- Page change: UP/DOWN buttons will change page to CRUISE page

Tapping ON/OFF will activate the cruise system in whichever of the set point modes was last highlighted.



## OPTIONAL TOWER SPEAKERS



The optional tower speakers are an additional set of speakers designed to allow the rider to be able to hear the music. The tower speakers require the addition of an amplifier to power the speakers.

### **CAUTION**

**Some lakes have noise restriction ordinances. The use of tower speakers may not be allowed in your area. Please check all applicable laws in your area regarding noise level restrictions.**

## OPTIONAL SUBWOOFER

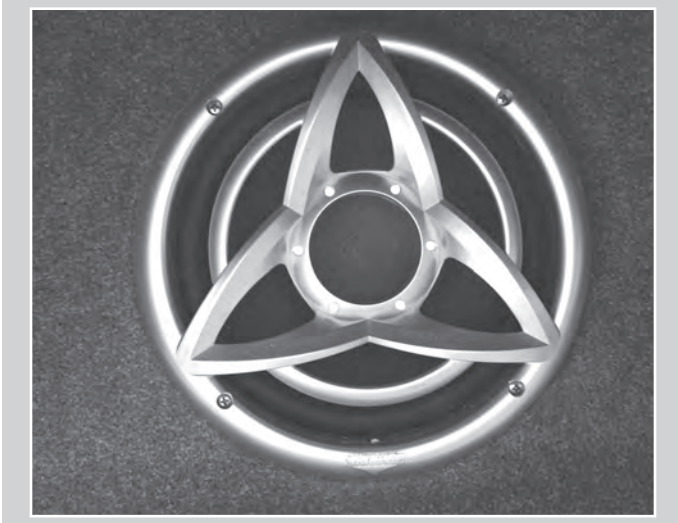

The optional sub-woofer is designed to increase the sound level of the bass notes. The optional amplifier powers the sub-woofer. The bass level can be adjusted on the amplifier. Please see stereo amplifier owner's manual for more information.

## OPTIONAL WALK-THROUGH CURTAIN

Some Moomba models offer an optional Walk-Through Curtain that snaps into the front walk-through to help prevent cool air from flowing into the cockpit area.

## OPTIONAL FRESH WATER COOLING SYSTEM

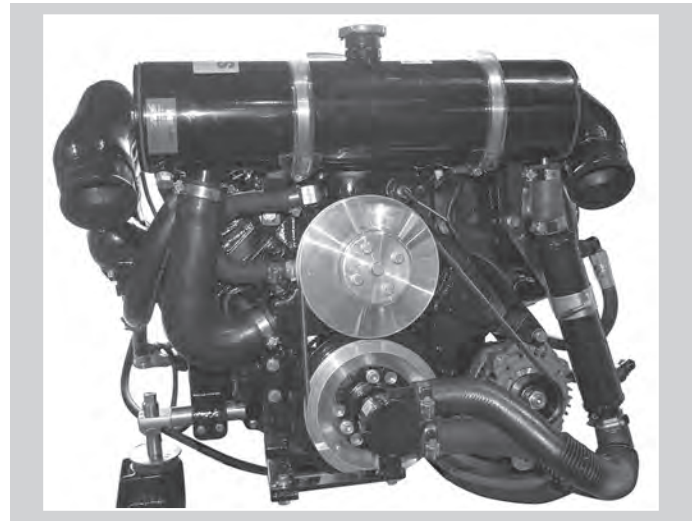

The optional fresh water cooling system has a heat exchanger which allows the engine to have an antifreeze mixture which circulates in the engine. For more information, see your engine owner's manual.

## OPTIONAL FRESH WATER FLUSH

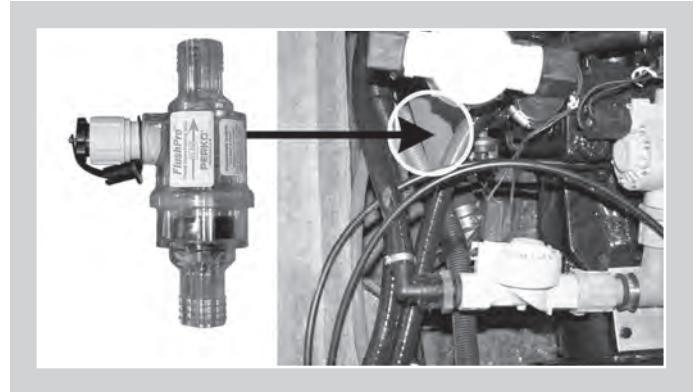

The optional Fresh Water Flush kit is a valve specifically designed to allow you to attach a garden hose to your engine water intake to flush brackish or salt water out of your engine. To use the Fresh Water Flush, simply attach a garden hose to the valve. Turn on the water to the valve. Start the engine. Monitor the exhaust ports on the transom of your boat and engine temperature gauge. Water should come out of the exhaust ports while the engine is running. It is recommended that you run the engine at a low RPM while flushing, since the engine's raw water pump at higher RPMs can pump more water than the garden hose can supply. If you have questions on the operation of your Fresh Water Flush kit, consult your Moomba Dealer.

## OPTIONAL STEREO AMP



The stereo amplifier is an optional piece of stereo equipment that is designed to increase the wattage of the signal going to the speakers while minimizing distortion of this signal. Please see stereo amplifier owner's manual for more information.

### **⚠ CAUTION**

**Using a stereo amplifier without boat engine running may drain the battery to the point where the boat will not restart. This condition may happen very quickly, depending on the size of the battery!**

## OPTIONAL TOWER SPEAKER AND LIGHT BAR COMBO



The optional tower speaker and light bar combo is a unit that houses both an additional set of tower speakers and lights. The speakers are designed to allow the rider to be able to hear the music. The tower speakers require the addition of an amplifier to power the speakers. The tower lights are designed to make docking, loading and unloading easier. The tower lights require the addition of a dual-battery electrical system.

**NOTE: Tower lights are not to be used as running lights at night. USCG regulations mandate that a boat under power after sunset must display a 360 degree white light and a red/green bow light.**

### **⚠ WARNING**

**It is illegal to wakeboard, ski, tube, etc., after sunset and before sunrise in most states. It has been outlawed because it is dangerous. Tower lights do not make these activities legal or safe.**

## OPTIONAL CD CHANGER

The optional 10 disc CD changer is mounted to the floor of the boat and is controlled using the stereo controls. It can also be controlled by the stereo remote. Please see CD changer owner's manual for more information.

## OPTIONAL TONNEAU COVER



The optional tonneau cover is designed to snap over the bow of the boat. Its purpose is to minimize air flow into the cockpit area when the boat is in use and as a storage cover when used in combination with the optional cockpit cover.

### **⚠ CAUTION**

**DO NOT trailer the boat with the tonneau cover installed. The tonneau cover is not designed as a trailer cover and may come unsnapped or rip. This type of damage IS NOT covered by your boat warranty!**

## OPTIONAL COCKPIT COVER



The optional cockpit cover is a snap down storage cover designed to help protect the interior of your boat. To install the cover, start at the windshield and work towards the transom. Be sure to install the cover poles to prevent water pocketing.

### **⚠ CAUTION**

**DO NOT trailer the boat with the cockpit cover installed. The cockpit cover IS NOT designed as a trailer cover and may come unsnapped or rip. This type of damage IS NOT covered by your boat warranty!**

## OPTIONAL TRANSOM MOUNT STEREO REMOTE



The optional transom mounted stereo remote allows the stereo to be controlled from the rear of the boat.

**⚠ DANGER** Keep away from rear of boat while the engine is running. Do not be on or about the swim platform while the engine is running or the boat is in motion.

## OPTIONAL SWIVEL PYLON



The swivel pylon option has a spool that swivels as the rope goes back and forth.

## OPTIONAL DOCKING LIGHTS

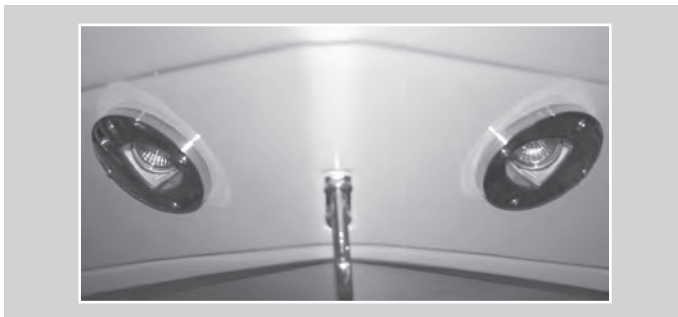

The optional docking lights are designed to help you dock, load and unload your boat in low light or at night.

**NOTE: Docking lights are not to be used as running lights at night. USCG regulations mandate that a boat under power after sunset must display a 360 degree white light and a red/green bow light.**

## OPTIONAL AUTOMATIC FIRE SUPPRESSION SYSTEM



The optional Automatic Fire Suppression System has a sensor in the engine compartment that is designed to detect a fire. Under normal conditions, the dash area warning light will glow green when the ignition is "ON". If the engine compartment sensor is activated by a fire, it will deploy the content of its fire extinguisher and the dash mounted warning light will turn red.

## OPTIONAL BOW FILLER CUSHION



The optional bow filler cushion is a cushion designed to fit in the bow of the boat. It fits between the port and starboard bow cushions and makes the bow area a solid cushion.

## OPTIONAL BOAT HEATER



The boat heater is a forced air heater that uses hot engine water as a heat source. To use the heater, simply turn the heater switch to the selected fan speed. In order for the heater to work, the engine must be at operating temperature. One of the features of the heater are the snorkel vents, which can be pulled out to direct heat to specific areas.

**NOTE: Location may vary by model.**

## OPTIONAL ENGINE WATER STRAINER



The optional engine water strainer is a filter for the engine cooling water. It is recommended for boats that are going to be operated in weedy conditions or other areas where debris could clog the engine. It consists of a stainless steel mesh filter inside a clear cup. It is located between the water intake on the bottom of the boat and the engine's raw water pump. It should be checked periodically for debris as conditions dictate. To remove debris, unscrew the clear sight cup, remove the o-ring and stainless steel filter mesh and proceed to rinse out the cup. Be sure to reinstall the filter mesh and o-ring before reattaching the sight cup to the inlet.

## DUAL BATTERY OPTION HOOKUP

The dual battery option is designed to give you extra battery power to run accessories, but at the same time give you a safety feature not commonly found in a dual battery setup. The Moomba Dual battery option features a Voltage Sensitive relay which always monitors the engine starting battery so that your engine will always restart.

We recommend that the selector switch always be set to "1". In the "1" position, the Voltage Sensitive Relay monitors the engine starting battery, which will ensure that you have a fully charged battery to start your boat. The "house" or accessory battery may become drained during a high discharge cycle since it does not get charged until the starting battery is fully charged.

In position "1" when the sensed battery (engine starting battery) reaches 13.7 volts, the relay closes and parallels both batteries. When this happens the LED light on Voltage Sensitive Relay comes on.

In position "2" the sensed battery is the accessory battery. We do not recommend using this position since it can cause the starting battery to drain, which would not allow the engine battery to have enough power to restart your boat.

In position "both", the batteries are paralleled and in a high discharge cycle, both batteries can become drained, which would not allow the engine battery to have enough power to restart your boat.

**NOTE: It is recommended that you fully recharge your batteries using a battery charger periodically or after a session of high discharge (lots of accessories running for an extended period).**

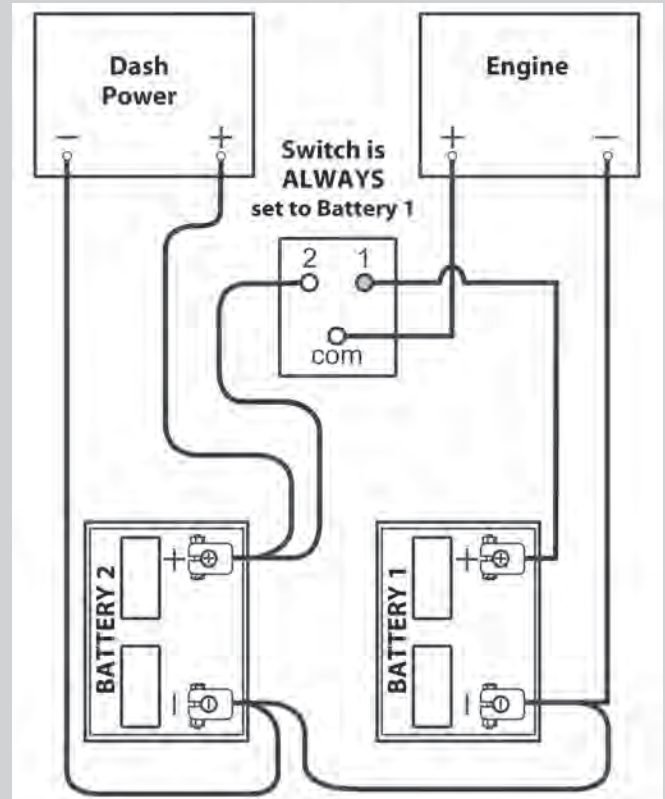

**NOTE: It is possible with this system for accessories to shut down when the engine is running due to the accessory battery draining down. This is a safety feature. This system monitors the starting battery and will sacrifice the accessory battery so that you are not stranded on the water with a weak starting battery.**

**NOTE: We highly recommend using high quality "Dual-Purpose Batteries" in both the starting and house position.**



**Typical Inboard**

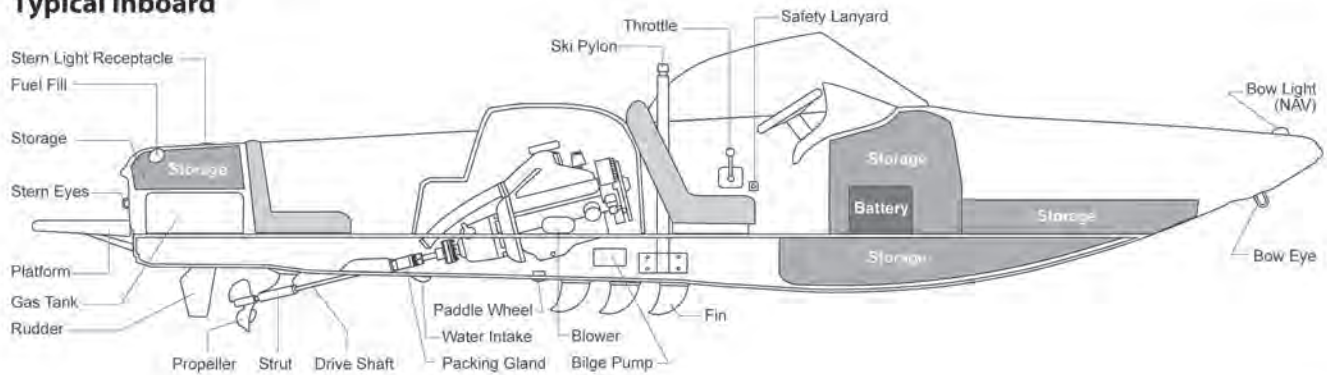

**Typical V-Drive**

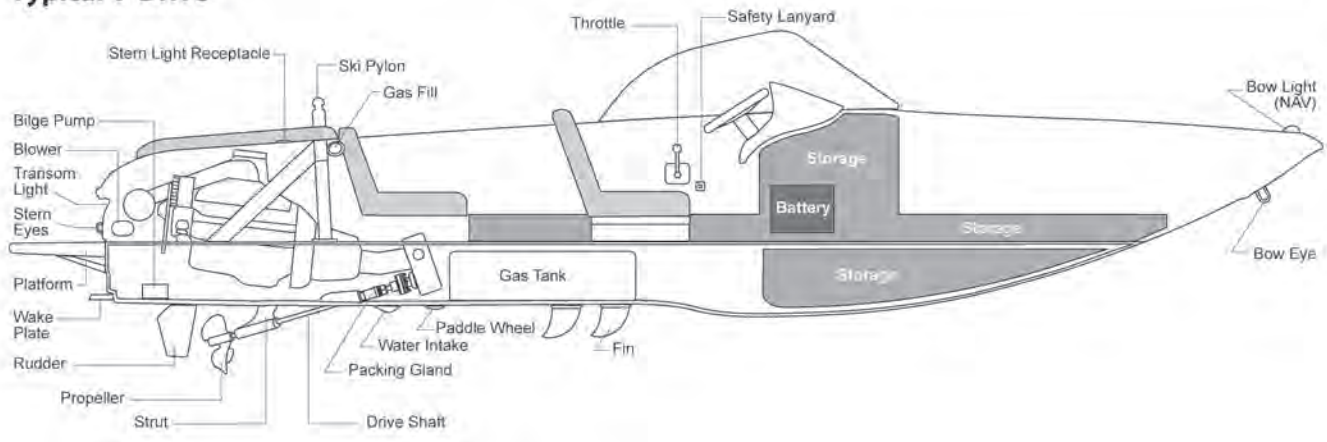

The illustrations above denotes the areas which may need to be accessed or may require cleaning or maintenance. It is important to have a basic understanding of the parts and their locations on the boat. However, it is recommended that any service beyond routine maintenance be performed by an authorized Moomba dealer.

**SERVICE & MAINTENANCE**

For your convenience a maintenance chart has been included in this manual. The chart indicates when to perform safety checks, lubrication, and general service to the boat. Engine hours or elapsed time determine when service is necessary.

It is recommended that any replacement parts used during maintenance or for repair be supplied by an authorized Moomba dealer.

**NOTE: You are responsible for keeping records of all maintenance on your boat. To maintain your new boat warranty, you may be asked to show that required maintenance was performed.**

Maintenance Intervals @ Engine Hours

Maintenance To Perform	Weekly	1st 25	50	100	Yearly
Change Engine Oil		X	X	X	X
Replace Oil Filter		X	X	X	X
Clean Oil Filler Cap				X	
Check Transmission Fluid Level	X	X	X	X	X
Change Transmission Fluid		X			X
Check Water Strainer (if applicable)*	X	X	X	X	X
Clean Flame Arrestor		X		X	X
Clean Crankcase Ventilating System		X	X		X
Check Water Pump & Alternator Belt Tension	X	X			X
Check Fuel Lines & Connections for Leaks	X	X	X	X	X
Impeller Replacement				X	X
Clean Transmission Oil Strainer Screen					X
Lubricate Distributor Cam					X
Check Condition of Spark Plugs					X
Check Battery Electrolyte Level		X	X	X	X
Check All Electrical Connections		X			X
Check Cooling System Hoses for Leaks	X	X			X
Tighten Engine Mount Fasteners					X
Lubricate Shift Linkage Pivot Points					X
Check for Loose, Damaged or Missing Parts	X	X			X
Check Engine to Propeller Shaft Alignment		X		X	X
Check V-Drive Fluid Level**	X	X	X	X	X
Change V-Drive & Transmission Fluid**		X			X

\* If engine overheats, visually check. If clogged, remove debris.

\*\* Pertains to V-Drives only.

*This inspection and maintaining schedule is recommended for average operating conditions in normal service. Under severe operating conditions or service, intervals should be shortened.*

## COOLING SYSTEMS

### Fresh Water Cooling System

The standard cooling system for Moomba boats is an open circulating cooling system with water intake. This is preferred for lakes and reservoirs with low salt content. If the engine is occasionally operated in salt water, the cooling system should be flushed with fresh water periodically and always before storage. If your boat is regularly operated in salt water, it should be equipped with the optional salt water package.

### Salt Water Cooling System

The optional cooling system for use on salt water is a closed system with a solution of 50% antifreeze and 50% fresh water. The coolant is left in the closed system and replaced once a year.

## BODY LUBRICATION

Normal use of your Moomba causes metal to metal movement at some parts in the boat. The driver seat track should be lubricated with a water resistant chassis lubricant such as silicon grease.



## ENGINE OIL & FILTER

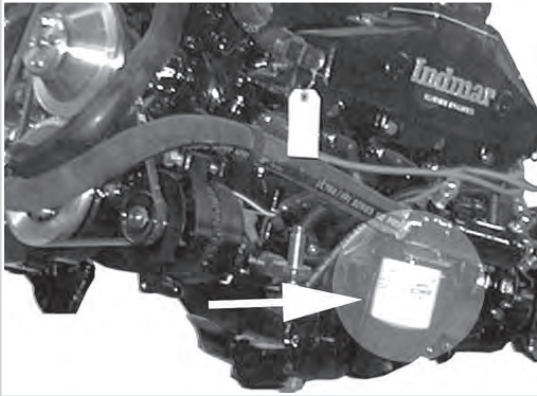

The oil filter is located below the engine. The engine manufacturer recommends that you change the oil and oil filter after the first 10-20 hours use of your new boat. Thereafter, to maximize engine life, change oil and filter after every 50 hours of use (See Engine Manual.)

**REFER TO ENGINE MANUAL for more information.**

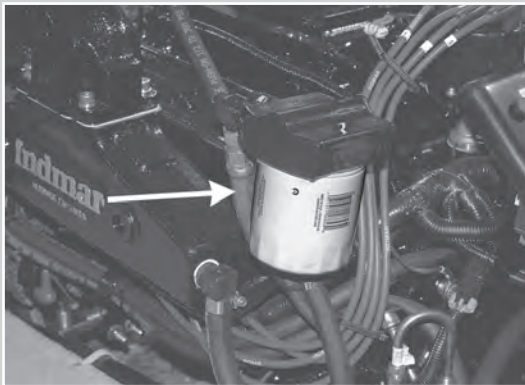

### REMOTE OIL FILTER

In the V-drive engine configuration the remote oil filter is mounted in a convenient spot in the engine compartment.

## DIPSTICK



### Oil Level Check

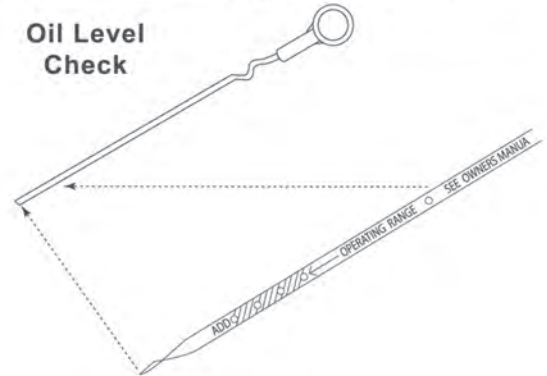

If the oil pressure indication is too high or too low, stop the engine immediately and check the oil level on the dipstick.

**NOTE: The oil pressure varies with engine temperature and speed. If oil pressure does not increase when throttle is increased, shut off the engine immediately.**

**Continued operation while oil level is incorrect or without pressure may result in serious engine damage. Report any problem to your dealer as soon as possible, and do not operate engine until corrected.**

## ENGINE OIL SPECIFICATIONS

The engine crankcase oil should be selected to deliver the highest performance for your operating conditions and climate. In general, engine oils with lower viscosity ratings are used when outdoor temperature remains low. Oils with higher viscosity are used when outdoor temperature is warmer and when higher performance is expected from the engine.

Indmar recommends 15W-40 Pennzoil Marine in their engines. If not available, use a 15W40 motor oil with an A.P.I. classification rating of SL/SJ/CI4/CH4/CG4 or equivalent. Synthetic oils are not recommended until after the engine has been run for 100 hours.

Refer to Engine Manual for more information. For filter and capacity information, see the Engine Data table in this manual.

## TRANSMISSION

### DIRECT DRIVE

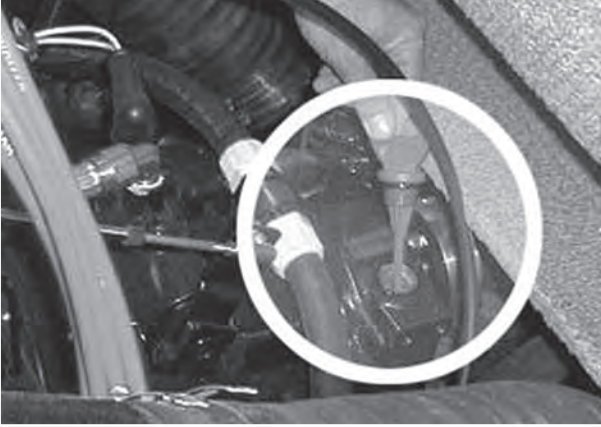

### V-DRIVE

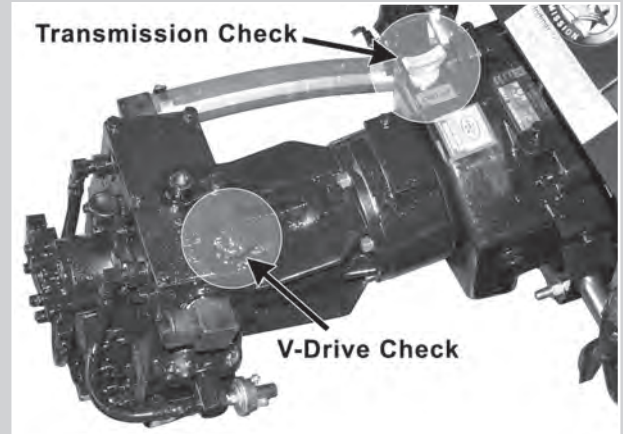

Transmission fluid level should be checked regularly (such as every ten engine hours) and fluid added if necessary. Maintain fluid level as follows:

- Boat must be at rest.
- Engine should be at operating temperature, but turned off while checking level.
- Remove transmission fluid dipstick.
- Wipe fluid clean from dipstick and replace.
- Remove dipstick and note level indicated by the upper and lower marks.
- If required, add fluid to bring the level to the upper mark.

### MAINTAINING FLUID LEVEL

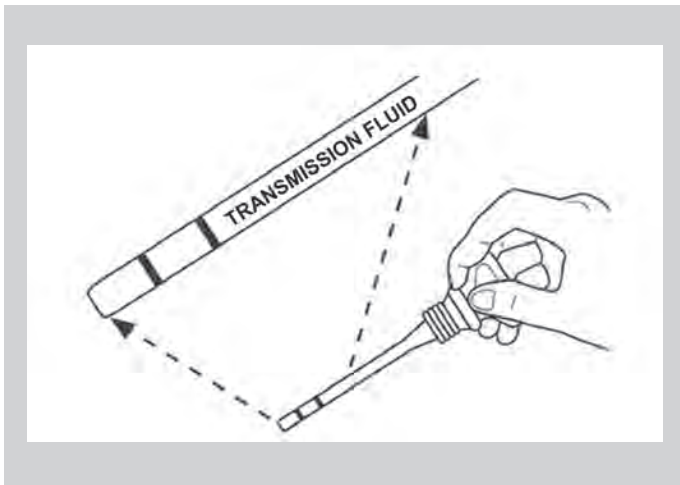

Use only Dextron III transmission fluid in transmissions with 1:1 drive train. To check fluid level, refer to Engine Manual.

#### **Change Frequency:**

Change transmission fluid every year (refer to Engine Manual).

### DRIPLESS SHAFT SEAL

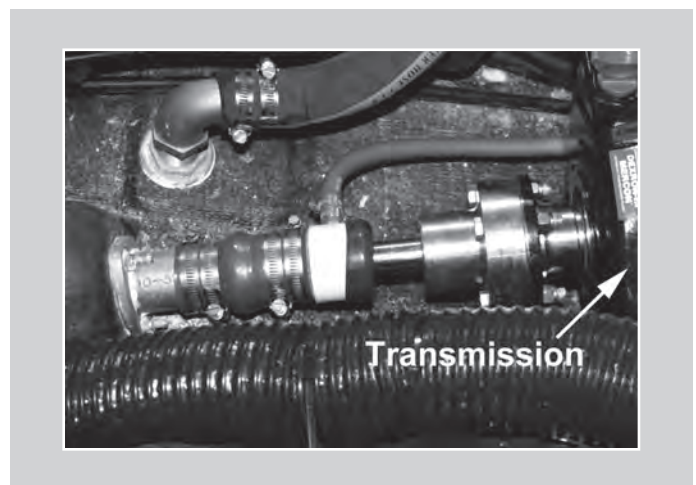

Your Moomba comes standard with a dripless shaft seal. If any seepage occurs, contact your dealer.

## V-DRIVE LOCATION

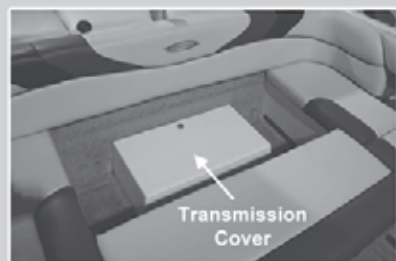

The fluid level can be checked by using the oil level dipstick, which is located on top of the V-Drive transmission. This unit's located under the center cushion of the rear seat. Pull out the cushion to access the transmission.

## V-DRIVE FLUID CHECK

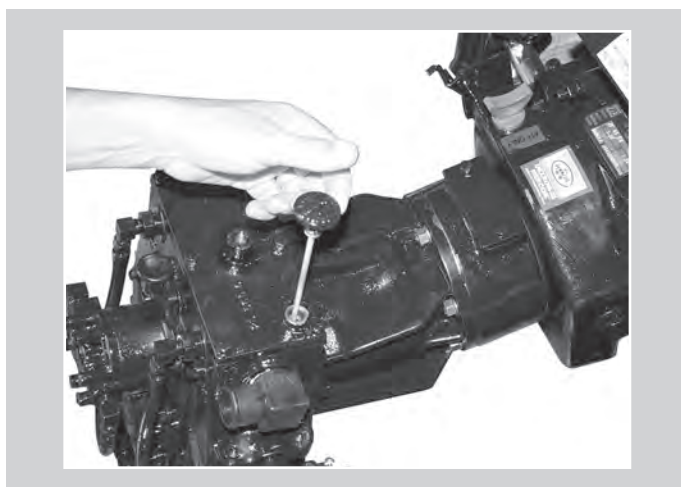

Pull the V-Drive Oil Level dipstick to check the fluid level. If the level is low, add fluid to the correct mark on the dip stick. Use SAE 30 motor oil.

**NOTE: Only a trained and qualified technician should perform the oil change on your V-Drive unit.**

## CHANGE FREQUENCY

The oil should be changed in the V-Drive transmission after the first 100 hours of operation, then each year at the end of your boating season.

## MAINTAINING FLUID LEVEL

V-Drive oil level should be checked regularly (such as every ten engine hours) and fluid added if necessary. Maintain fluid level as follows:

- Boat must be at rest.
- Engine should be at operating temperature, but turned off while checking level.
- Remove V-Drive Unit dipstick.
- Wipe fluid clean from dipstick and replace.
- Remove dipstick and note level indicated by the upper and lower marks.
- If required, add fluid to bring the level to the upper mark.

## PROPELLER WARNING

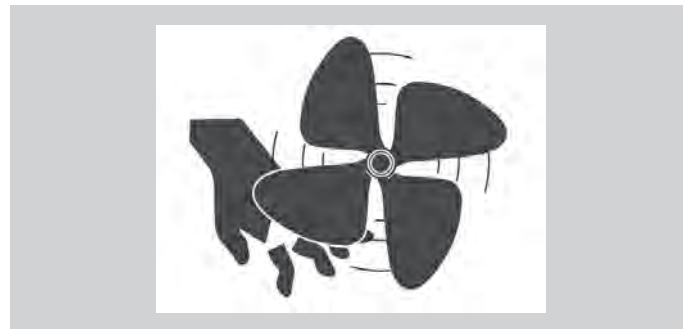

### **⚠ WARNING**

**Moving propeller will cause injury. Propeller may rotate with boat in neutral. Shut off the engine when people are on the platform or in the water near the platform to avoid injury from the prop rotation.**

## BATTERY CABLE INSTALLATION & PRECAUTIONS

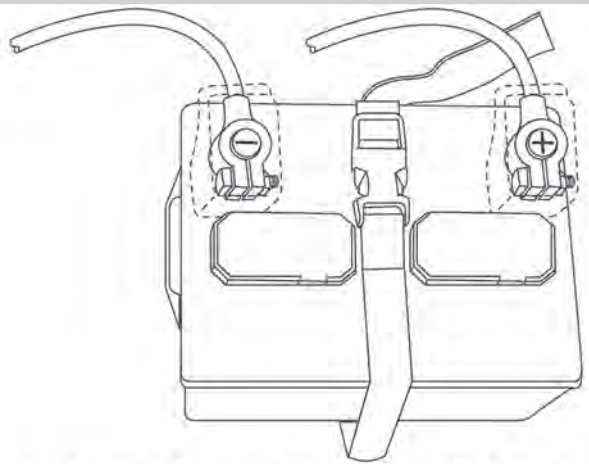
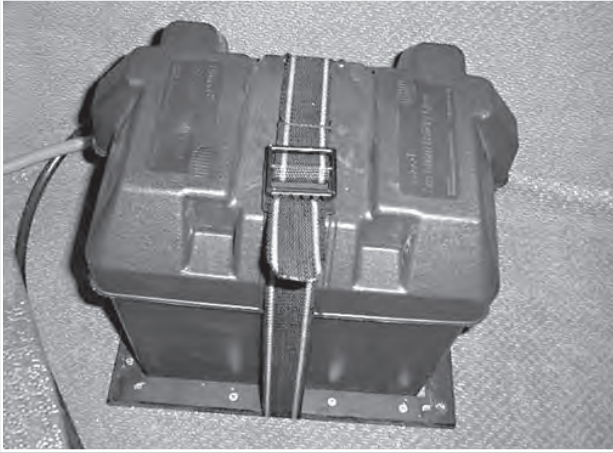

Use a good quality marine grade battery

Your battery is an important part of your boat. It provides all of the power to start your boat and also allows all of your electrical components to work, even if the motor is not running (bilge pump, blower, stereo, etc.).

Because of its important role, Moomba recommends using a good quality "Marine Dual Purpose" battery. The "Dual Purpose" rating means that it can provide the cranking Amps needed to start your motor and also has an Amp hour discharge rating so it can handle low electrical draw-down cycle.

Your Moomba electrical system is negative ground. The negative battery cable is grounded on the engine block. The positive battery cable is connected to the starter solenoid.

Connect the positive (+) battery cable to the positive (+) post on the battery. Connect the negative (-) battery cable to the negative (-) post on the battery.

### CAUTION

Failure to connect battery cables as outlined will damage the system and void the warranty.



### WARNING

Hydrogen and oxygen gases are produced during normal battery operation and charging. Sparks or flames near the battery vent openings can cause the mixture to ignite and explode.



### WARNING

Sulfuric acid in the battery can cause serious burns. If spilled on skin or in the eyes, flush with clean water immediately, then seek medical attention.

### FIBERGLASS CARE

Washing and waxing the boat hull and deck regularly will extend the life and beauty of your Moomba. It is a good routine to rinse your boat with fresh water after each day's use.

It is recommended that the hull and deck be cleaned and waxed after every 50 hours of use. This will decrease water friction and lessen the potential for staining or spotting on the gel coat surface.

When the original gel coat shine cannot be restored by waxing, the shine may be restored by hand buffing with a commercial polishing compound. Be sure to apply a new coat of wax containing Carnauba over the area that has been polished.

**IMPORTANT: Porcelain cleaning powders are too abrasive for use on gel coat and may cause permanent discoloration if used. Household detergents containing ammonia or chlorine should not be used on gel coat. Never use acetone or ketone solvents to clean your boat finish.**

### WASHING YOUR MOOMBA



The easiest way to preserve the beauty of your boat is to keep it clean by frequent washing. Wash the boat with luke warm or cold water. Wipe the boat down immediately after washing to avoid water spots. Avoid using hot water or washing your boat in direct sunlight. Avoid using strong soaps or chemical detergents. To avoid spotting, all cleaning agents should be thoroughly rinsed from the surface promptly and not allowed to dry on the finish.

### RUB RAIL CARE

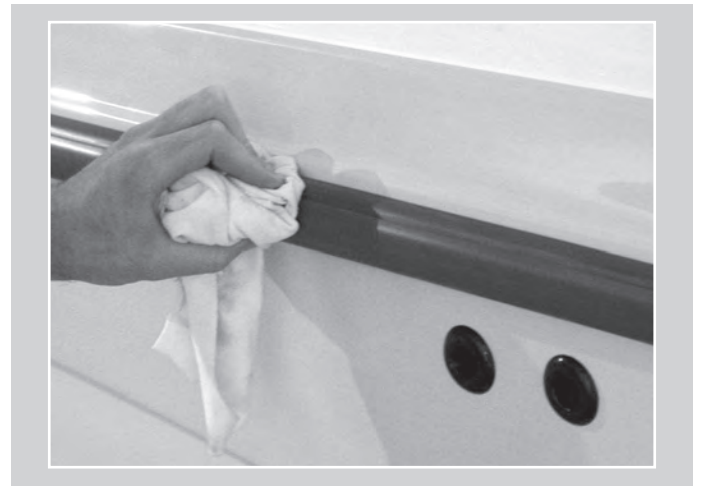

Use a sponge or other soft material to wash and wax the rub rail.

To wax, use a commercial automotive bumper wax.

**NOTE: When tying up to a dock or another boat, always use cushioned fenders (dock bumpers) to protect your boat from hard surfaces.**

### WINDSHIELD CARE

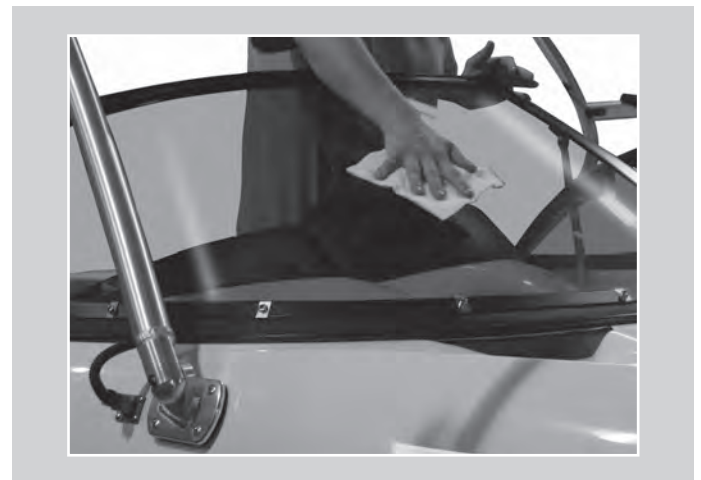

Clean the windshield regularly to ensure that visibility is not obstructed.

Use a commercial glass cleaner to remove any spotting or stubborn stains that develop on the windshield.

Never use abrasive cleaners on glass or plastic surfaces as they may cause scratches.

## UPHOLSTERY CLEANING

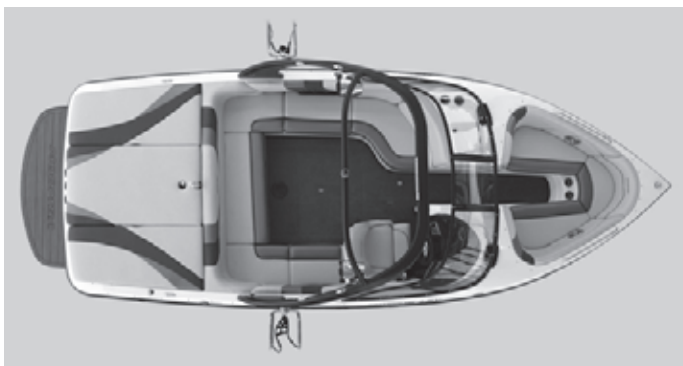

All upholstery items on your boat are made of tough marine grade vinyl that is easily cleaned with a mild detergent.

**Strong detergents and cleaners may shorten the life of the vinyl. PLEASE SEE VINYL MANUFACTURER'S RECOMMENDED CARE GUIDE INCLUDED IN YOUR OWNER'S PACKAGE.**

## DRYING UPHOLSTERY

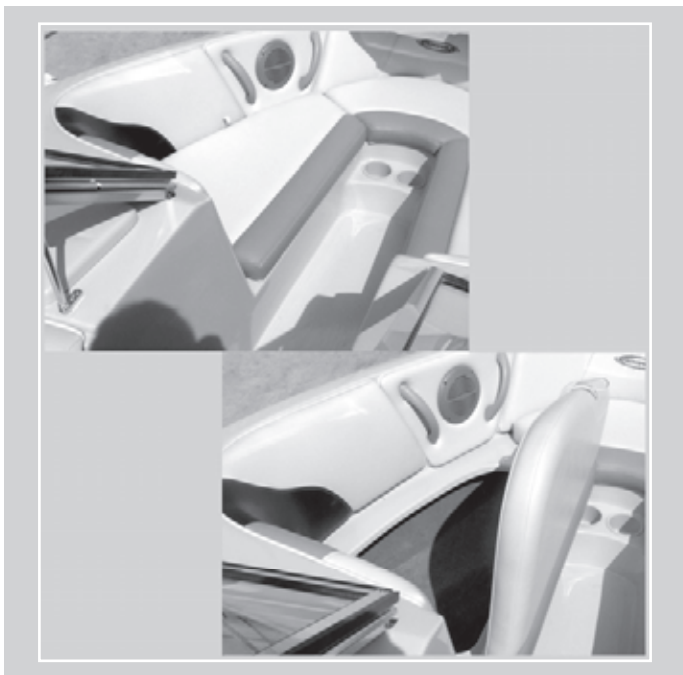

It is important to provide for the drying of all upholstery and carpet after each use of the boat. Open all storage compartments and slide all removable cushions out about an inch to allow air to circulate behind.

## FOREIGN DEPOSITS

Tree sap, bird droppings, airborne chemicals, petroleum products and other foreign matter may damage the gel coat surface if not removed promptly (See Washing Instructions).

### Boat Hull Protection

If your Moomba is to remain in the water for an extended period, the hull below the water line should be painted with a marine bottom paint. Boats left in the water for extended periods of time without bottom paint may experience blistering or discolorization. This type of damage is not covered by your boat's warranty.

### Teakwood Care

If teakwood has been installed on your Moomba, a small amount of maintenance will be required to retain the natural beauty. Teakwood should not be varnished. Instead, teak oil or mineral oil should be applied. Oil should be applied three to four times per year. If teak has been allowed to become gray and dry, sand with fine grit paper and reapply teak oil.

### **⚠ CAUTION**

**Damage caused by improper care, cleaning agents, conditioner oils, waxes, gasoline, etc., IS NOT covered under your boat's warranty. Use only the recommended vinyl cleaner as listed on the Vinyl Care Instruction Sheet.**

Please refer to [www.spradlingvinyl.com](http://www.spradlingvinyl.com) for more information regarding vinyl care.

## WET SLIPPING BOATS

### **⚠ CAUTION**

- In the event of large storms, boats in wet slips are more likely to be damaged.
- If you do not use the boat often, the battery can go dead from pumping out water.
- The boat may develop organic growth which can greatly reduce performance, attack and discolor the gelcoat.\*
- The boat may develop osmotic blisters.\*
- The boat may get a stain line which cannot be removed.\*

*\*Painting the area below the waterline of the boat with Pettit or Interlux products will reduce the likelihood of these last three.*

### WINTERIZATION

When the boating and ski season comes to a close, it is important to have your boat professionally winterized.

If your boat is exposed to temperatures below 32 degrees F (0 degrees C), it is possible for water in the engine, ballast system, heater core, etc., to freeze. As this water freezes, it expands and can crack pumps, valves, heat exchangers, engine blocks, etc. This type of damage usually requires the replacement of the cracked item and can be very expensive to repair.

#### **CAUTION**

**It is extremely important to follow the proper winterizing procedure. The engine must be correctly winterized for safe storage in your climate. This should be done by a professional. Your Moomba dealer will know exactly what must be done to ensure the longest possible life for your boat.**

**In addition to having your boat professionally winterized, the following tasks should be done to protect your boat during storage:**

- Remove the center drain plug from the boat.
- Thoroughly clean the boat inside and out. Inspect the hull for any residue or algae growth and remove if required.
- Clean the bilge area thoroughly and operate the bilge pump to remove any water from the bilge hose.
- Remove all seat cushions and open all storage areas to allow air circulation in the boat interior.
- When thoroughly dry, replace cushions and close storage areas.
- Top off fuel tank to prevent any condensation from accumulating in the fuel system. Use a commercially available fuel stabilizer to remove water and prevent gumming.
- If the boat is stored on its trailer, ensure that the boat is properly positioned. If possible, lift the tongue so that the bow is slightly raised to promote drainage from the drain hole.
- Install the canvas cover and secure the straps in accordance with cover instructions.

**NOTE: During the winter months, water is a boat's worst enemy. Always store the boat when the interior is completely dry. Periodically check on the condition of the stored boat.**

#### **CAUTION**

**Damage due to improper winterization IS NOT covered under your boat's warranty.**

#### **CAUTION**

**E-10 fuels require fuel stabilizers that are specifically designed for E-10 fuels to help prevent moisture absorption, phase separation and gasoline stabilization.**

### SUMMERIZATION

Before using the boat after it has been in dry storage requires some special treatment. Moomba recommends having your boat professionally summerized, preferably by the same facility that prepped it for storage. They will be familiar with what items were done in the fall and what items need to be addressed in the spring.

**In addition to having your boat professionally summerized, the following list of tasks should be done to ensure a successful start to your boating season.**

<input type="checkbox"/> Check Trailer	
<input type="checkbox"/> Tire Pressure	
<input type="checkbox"/> Bearing Lube	
<input type="checkbox"/> Brake Fluid	
<input type="checkbox"/> Lights	
<hr/>	
<input type="checkbox"/> Check Battery	
<input type="checkbox"/> Clean & Wax Gel Coat	
<input type="checkbox"/> Clean Interior	
<hr/>	
<input type="checkbox"/> Check All Systems	
<input type="checkbox"/> Blower	
<input type="checkbox"/> Bilge Pump	
<input type="checkbox"/> Navigation Lights	
<input type="checkbox"/> Interior Lights	

When launching the boat for the first time of the season, carefully watch all gauges to ensure that the boat is not overheating, the alternator is charging and the engine has proper oil pressure.

## HOISTING

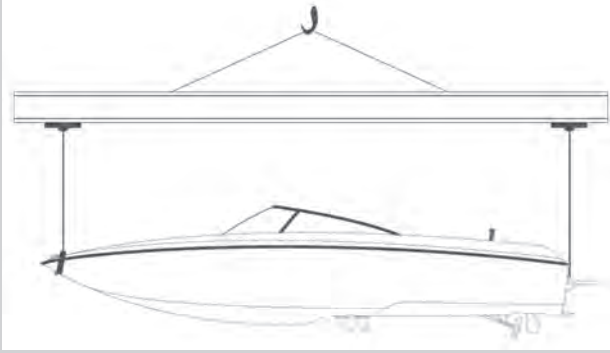

**CORRECT HOISTING**

If the boat ever needs to be hoisted, special attention should be given to the following recommendations:

- Hoist the boat using a horizontal lifting bar only.
- Never attempt to lift the boat by means of a cable sling from bow to stern lifting eyes.
- Hoist operator should slowly and smoothly lift the boat without jerking to avoid damage to the lifting eyes.
- Use a clevis inserted through the lifting eye since a hook may damage the lifting eye edges.

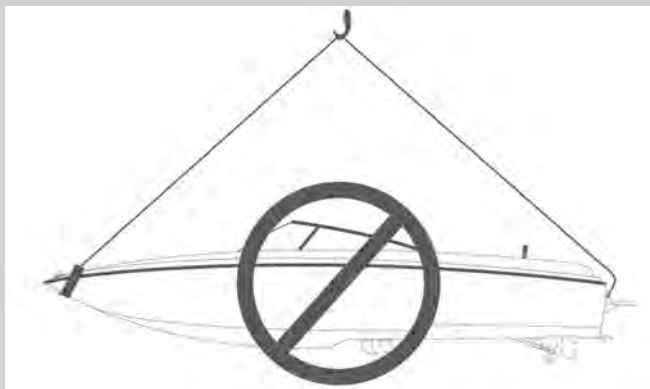

**INCORRECT HOISTING**

### **⚠ WARNING**

**DO NOT** use the ski pylon to hoist the boat. Incorrect hoisting may invalidate the warranty on the boat.



**CORRECT HOISTING**

### **⚠ WARNING**

Use only a proper sized sling in the designated lifting rings to hoist the boat.

**NOTE:** For boat houses or other applications where the boat will be lifted and held in that position, Moomba recommends using a cradle. The bunk configuration should mimic the trailer.



**IDENTIFICATION NUMBER**

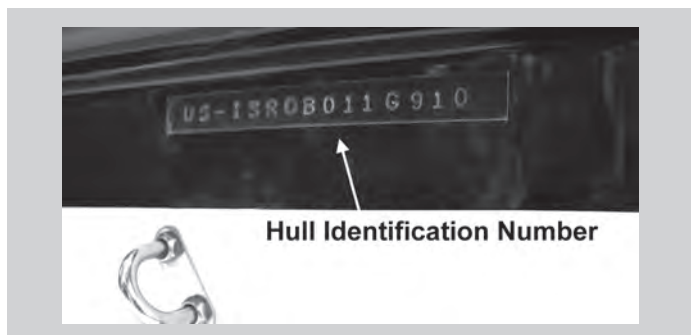

The hull identification number is located on the upper right hand side of the transom below the rub rail.

**BATTERY SPECIFICATIONS**

12 Volt Marine Type with Tapered Post Connectors	
Engine Size:	Cold Crank @ 0° F (-18° C)
350	Minimum of 650 Amps

**A good Quality Marine Dual Purpose Battery is recommended.**

**⚠ WARNING**

**Hydrogen and oxygen gases are produced during normal battery operation or charging. Sparks or flames can cause this mixture to ignite and explode if it comes near the vent openings. Sulfuric acid in the battery can cause serious burns if spilled on skin or in eyes. Flush with clear water immediately!**

**2011 Moomba Engine & Transmission Data**

Engine Model:	Indmar Assault MPI 325	Indmar Assault MPI 340	Indmar Assault MPI 409
Fuel Delivery	Multi-Port Fuel Injection	Multi-Port Fuel Injection	Multi-Port Fuel Injection
Horsepower:	325 HP	340 HP	409 HP
Displacement:	350 CI	350 CI	364 CI
Bore (in):	4.00	4.00	4.00
Stroke (in):	3.48	3.48	3.62
Compression Ratio:	9.4 to 1	9.4 to 1	9.6 to 1 (Premium Fuel Required)
Electrical System:	12-V Negative Ground	12-V Negative Ground	12-V Negative Ground
Ignition Type:	Electronic Distributor	Electronic Distributor	Electronic Distributorless Coil Near Plug
Alternator Output:	70 Amps @ 1,200 RPM	90 Amps @ 1,200 RPM	90 Amps @ 1,200 RPM
Thermostat:	162 Degrees F	162 Degrees F	162 Degrees F
Firing Order:	1-8-4-3-6-5-7-2	1-8-4-3-6-5-7-2	1-8-7-2-6-5-4-3
Initial Timing:	Non-Adjustable	Non-Adjustable	Non-Adjustable
Oil Filter:	Pennzoil PZ - 52	Pennzoil PZ - 52	Pennzoil PZ - 167
Oil Capacity:	5.5 - Quarts	5.5 - Quarts	6 - Quarts
Oil Type:	Pennzoil 15W - 40 Marine	Pennzoil 15W - 40 Marine	Pennzoil 15W - 40 Marine
Spark Plugs:	AC 41 - 101	AC 41 - 101	AC 41 - 110
Gap (in):	0.040	0.040	0.040
RPM Range @ WOT:	4,400 - 4,800 RPM	4,600 - 5,200 RPM	5,200 - 5,600 RPM
Fuel Type:	89 Octane - Unleaded	89 Octane - Unleaded	92 Octane - Unleaded

## 2011 Moomba Electrical Replacements

Fuses	Type	Size
<b>Under Dash</b>		
Ballast Main (3 Position)	Breaker	50 Amp
Ballast Empty Pump (1 Position)	ATO	5 Amp
Ballast Fill Pump (1 Position)	Breaker	10 Amp
Stereo	Breaker	10 Amp
Wake Plate	Breaker	20 Amp
<b>Battery Connection</b>		
Amp Harness (5 Channel)	ANL	100 Amp
Amp Harness (4 Channel)	MAX	30 Amp
Amp Harness (2 Channel)	ATO	40 Amp
<b>Back of Engine</b>		
Fuel Pump	ATM	20 Amp
Engine Ignition	ATM	20 Amp
Starter	ATM	20 Amp
<b>Bulbs</b>		
Bow Light	3175	12V8W
Pole Light	906	12V
Docking Lights	MR16	50W 24 Degree
Tower Light Bar	H3	12V55W
Courtesy Lights	Sealed	(See Dealer)

**Fuse Panel - Under Dash**



**Fuse Panel - Battery Connection**



**Fuse Panel - Back of Engine**



**Main Dash Power-Circuit Breaker**



The power to the dash circuit is protected by a circuit breaker that is located in the observer seat storage area near the battery.

To turn off the power to the dash, manually press the red button and the circuit breaker reset lever will flip down and the power to the dash circuit will be shut off. To reset the breaker, push the reset lever back up.

If all of the dash switches fail to work, reset the main dash power-circuit breaker.

**TRAILER & TOWING**



The trailer supplied with your Moomba model was designed especially for the boat with your convenience in mind. Please be sure that you have an appropriate tow vehicle before attempting to trailer your boat. Your vehicle must be capable of towing 3,500 — 6,000 lbs., depending on the model.

**CAUTION**

Read the trailer towing section of your vehicle owner's manual before towing your trailer.

All Moomba trailers require a 2" ball and a five (5) pin marine grade trailer wiring connector. The standard height from the ground to the top of the hitch ball should be about 20 inches. With the trailer attached to the tow vehicle, the trailer should stand level.

**Trailer Plug Wire Schematic**

White: Ground	Brown: Running Lights
Green: Right Turn/Brake	Blue: Reverse Lights
Yellow: Left Turn/Brake	

**NOTE:** Moomba trailers feature disk brakes. The fifth wire (blue) on the wire connector needs to be connected to your vehicle's reverse lights to be operative. This wire (blue) provides power to a solenoid which deactivates the brakes while in reverse. You may still tow your trailer without the blue wire connected, however, you may experience difficulty backing the trailer.

**WARNING**

**BEFORE USE, READ ALL INFORMATION SUPPLIED WITH THE TRAILER BY THE MANUFACTURER.**

**The following guidelines will prolong the life of the boat and trailer:**

1. Always secure the boat to the trailer with tie-downs. Do not place straps around fenders or lights.
2. Always verify that the winch hook is securely in the bow eye, the strap is tight and the winch handle locked in place before trailering.
3. Check the recommended pressure displayed on the side of the tires and assure that it is maintained.
4. Under-inflated tires could cause trailer sway and excessive tire wear.
5. Verify that the trailer hitch on the tow vehicle is the proper class and size to support the tongue weight and the trailer load.
6. Check wheel bearing lube.

**CONNECTING THE TRAILER**



When connecting the trailer to your tow vehicle, use the following procedure:

1. Raise the tongue with the trailer jack, position the trailer tongue directly over the 2" ball, and lower the jack until the tongue goes all the way down over the ball.
2. Press down on the latch until it locks on the ball with a "click."

**NOTE:** If your hitch ball has an excessive flat spot on top, the latch may not engage properly. If the latch does not catch, check with your dealer or hitch installer before trailering.

3. Insert the locking pin into the tongue. Lock pin hole is on the side of the tongue.
4. When all weight is off the trailer jack, pull the jack lock pin and rotate the jack to the horizontal position and re-lock the pin.
5. Attach the safety cables to the tow vehicle hitch. Cross the cables and wrap them around each other once or possibly twice allowing just enough slack to permit tight turns of the vehicle and trailer.
6. Plug the trailer lights connector to the vehicle harness.
7. Clip the brake lockout cable to the vehicle hitch.

## UNLOADING PROCEDURE



**NOTE: DO NOT attempt to use excessive power to free the boat from dry carpet runners. Power off of the trailer only when the boat has floated free.**

### **⚠ CAUTION**

If the trailer is not submerged to the correct depth, the bow of the boat could drop when powering off incorrectly, possibly damaging the boat.

**NOTE: Before operating your Moomba, refer to the Daily Check List and the Boatman's Check List.**

To unload the boat use the following procedure as a guide:

1. Make sure that all drain plugs are securely in place.
2. Unplug light cord before backing into the water.
3. With Bow Eye Hook fastened, back the trailer until the water level is approximately one inch below the top of the trailer fenders.

**NOTE: Ramp slopes vary, so actual level of water on trailer may be different.**

### **⚠ CAUTION**

**Make sure that the engine water intake is fully submerged.**

4. Follow the cold start procedure recommended in this manual.
5. With engine idling, center the steering wheel, engage the transmission into reverse (pull back on lever,) then ease back on the throttle.

**NOTE: Because your Moomba is a direct drive inboard, when backing the stern will have a tendency to drift left or right depending on propeller rotation. This condition will self-correct as the rudder reaches control speed.**

## LOADING PROCEDURE



To re-trailer the boat, position the trailer in the water with approximately 1 inch of the top of the fender showing as in step 3. UNLOADING.

Idle/coast the boat onto the trailer using as little power as possible keeping it centered between the guide poles.

**NOTE: DO NOT Power onto the trailer during rough conditions.**

When correctly positioned on the trailer turn off ignition. Use the Hook and Trailer Winch to pull the boat up to the Roller Stop.

### **⚠ CAUTION**

**The trailer must be positioned for the correct water depth for loading or you may damage the boat. Varying ramp angles require different procedures. In general, the steeper the ramp, the more shallow the trailer should be positioned in the water. Your local dealer can help you understand this, should you require additional assistance.**

## TRAILER ALIGNMENT



**CORRECT ALIGNMENT**

When pulling the boat onto the trailer, be sure that it is centered on the trailer.



**INCORRECT ALIGNMENT**

The distance between the boat and the wheel runner board should be about equal on both sides.

## TRAILER BASICS

See Trailer Owner's Manual for additional product information, safety information and warnings.

### TANDEM AXLE



Some models come standard with a tandem axle trailer and with some it is an option.

### SECOND AXLE DISC BRAKES



The standard second axle disc brakes give the trailer more stopping power.

### LED PACKAGE



The standard LED lighting package replaces the traditional trailer lights with LED lights. The LED lights are brighter than the traditional lights.

**NOTE: Vehicles with trailer light monitors may not function properly with LED lights due to the low resistance of the LED lights. Aftermarket resistor packages are available which allow the monitors to work properly.**

### SWING-AWAY TONGUE



With the swing tongue, you can shorten the trailer length for storage by pulling the pin and swinging the tongue away to the side.

#### **⚠ WARNING**

DO NOT tow trailer without latch pin installed.

#### **⚠ CAUTION**

Always install safety clip on end of latch pin.

### SURGE BRAKES FLUID RESERVOIR



To check brake fluid, twist black cap and remove. Pry rubber plug out of reservoir. Follow instructions printed on plug. Use DOT 3 Brake Fluid.

### VAULT BEARINGS



Your trailer features Vault bearings. See trailer owner's manual for more information.

### OPTIONAL ALUMINUM STEP PLATE



The optional aluminum step plate gives the trailer a durable long-lasting, nonskid surface on the trailer steps.

### OPTIONAL LASER CUT STEPS



The optional laser cut steps are backlit so they illuminate when the trailer's running lights are illuminated.

### OPTIONAL SPARE TIRE BRACKET



The optional spare tire bracket allows you to conveniently carry a spare tire.

### OPTIONAL ALUMINUM WHEELS



The optional aluminum wheels are a trailer grade wheel. They are a great way to dress up your trailer.

### OPTIONAL HEAVY DUTY TRAILER JACK



The optional heavy duty trailer jack is a great way to dress up your trailer.





### **MOOMBA LIMITED WARRANTY**

Taking care of our product after it becomes yours has always been “standard policy” at Skier’s Choice, Inc., the proud manufacturer of the Moomba line of boats. And to further prove our point, we offer the following limited warranty.

#### **TERMS OF WARRANTY**

During the applicable Warranty Period (as defined below), Skier’s Choice, Inc. (“Skier’s Choice” or the “Company”) warrants to the original retail purchaser (the “First Owner”) that the components and parts manufactured by Skier’s Choice (the “Covered Components”) of each new Skier’s Choice boat are free from any defects in material and workmanship, under normal use and when operated and maintained according to boat’s instructions (“Normal Use and Operation”).

- This Limited Warranty applies to all Covered Components other than the deck, hull, floor and stringers for a period of one year (the “One-Year Warranty Period”) from the original date of purchase by the First Owner (the “Original Purchase Date”). Exclusions do apply.
- This Limited Warranty applies to the deck, hull, floor (excluding carpet) and stringers for the lifetime of the boat (the “Lifetime Warranty Period”). Exclusions do apply.
- This Limited Warranty applies to the gel coat for a period of one year (The “One-Year Warranty Period”) from the original date of purchase by the First Owner (The “Original Purchase Date”). Exclusions do apply.

This Moomba Limited Warranty may be transferred to a second owner. The remaining duration of the Moomba limited warranty from the first owner’s original purchase date is transferable. A nominal warranty transfer fee and a dealer inspection are required. Boats that are damaged or have been abused may not be eligible for the warranty transfer. Inspection and Fee need to be completed within 14 days of the sale to a subsequent owner or the boat will not be eligible for the warranty to transfer.

Subject to the terms of this Limited Warranty, Skier’s Choice will repair or replace, at its sole option, any Covered Component which is returned during the applicable Warranty Period to the Skier’s Choice factory or to any other Moomba authorized repair facility (an “Authorized Moomba Facility”), provided that:

- Only the Covered Components that are declared defective upon examination by Skier’s Choice will be repaired or replaced under this Limited Warranty;
- Transportation of the boat, parts or components to and from the Skier’s Choice factory or the Authorized Moomba Facility must be prepaid by the owner;
- Notice of any claim under this Limited Warranty must be provided to Skier’s Choice by the Authorized Moomba Facility no later than sixty (60) days after the owner becomes aware of the defect.
- The boat was purchased at a dealership authorized by Skier’s Choice, Inc. to distribute the product in the country in which the sale occurred.

Notification of a claim or defect must be properly made directly to an Authorized Moomba Facility, who subsequently must submit the claim information to Skier’s Choice, Inc. at 1717 Henry G. Lane Street, Maryville, Tennessee 37801. Information needed for processing a claim includes (1) Name and address of the owner; (2) Serial number of the boat; (3) Original retail purchase date; (4) Detailed explanation of the defect; and (5) Estimated repair cost.

**Note: Warranty repair or replacement cannot be made until this information is approved by Skier’s Choice.**

In case of defect of a Covered Component, Skier’s Choice will use its reasonable best efforts to repair or replace the Covered Component within ninety (90) days of receipt thereof at its factory or an Authorized Moomba Facility. Any warranty on replaced or repaired components pursuant to this Limited Warranty shall remain in effect only for the remainder of the original Warranty Period. The repair or replacement of Covered Components will be made by Skier’s Choice without charge to the owner for parts or labor. The replacement or repair of the defective part or component as stated in this Limited Warranty shall be the sole remedy of the owner and the sole liability of the Company under this Warranty and any implied warranties.

There are no express or implied warranties on the parts and components manufactured or sold by Skier’s Choice except as set forth in this Limited Warranty.

#### **EXCLUSIONS**

Claims or assertions relating to the following are specifically excluded from coverage under this Limited Warranty and Skier’s Choice disclaims any liability or obligation with respect to the following:

1. Defects in or damage caused by or relating to the engine or any part thereof. (Note: The engine may be covered by warranty of the engine manufacturer. Please see engine manufacturer warranty for details.)
2. Defects in or damage caused by or relating to the trailer or any part thereof. (Note: The trailer may be covered by warranty of the trailer manufacturer. Please see trailer manufacturer warranty for details.)
3. Covered Components of a boat that has been sold by the First Owner and the warranty transfer was not completed.
4. Damage caused by, related to, or resulting from failure of components or parts which are not manufactured by Skier’s Choice, including but not limited to bilge pump failure.
5. The Limited Lifetime Warranty on the deck, hull, floor (excluding carpet) and stringers does not include hardware or other components fastened or adhered to the hull, deck, floor or stringers.
6. Normal maintenance and upkeep relating to the boat or any part thereof, including but not limited to, alignment, adjustments, connectors, tune-ups and wear items, such as, shaft packing, belts, hoses, filters, seals, gaskets, strut bushing, etc.

7. Damage to or malfunction of a boat, or any component thereof, resulting from owner use, lack of maintenance, improper maintenance, impact, misuse, negligence, collision, delay in repair, improper hoisting or cradling of the boat.
8. Any and all consequential damages including, but not limited to, costs incurred for haul-out, launching, towing and storage charges, telephone or rental charges of any type, inconveniences, loss of use, or loss of time or income.
9. Equipment installed by anyone other than authorized factory personnel at the Company's production facility. Equipment replaced at an Authorized Moomba Facility pursuant to this warranty agreement remains under warranty until the expiration of the Limited Warranty period.
10. Any boat which is: (a) used for rental or other commercial, military or industrial purposes; (b) used in boat racing, demonstrations, ski school, or similar events; (c) altered, modified, repaired or replaced so as to increase the cubic inch capacity or horsepower output of the engine and boat as originally manufactured; (d) not properly stored or maintained.
11. Any boat which is: (a) repossession from a retail customer; (b) purchased at auction (bank auction, online auction, auction house, etc.); (c) purchased from a salvage yard; (d) purchased from an insurance company that obtained the product as a result of an insurance claim.
12. Speeds, fuel consumption and other performance characteristics because they are estimated and may vary.
13. Damage to or defects in paints, varnishes, gelcoat surfaces and colors, finish distortions, chrome plated or anodized finishes, floor covers and any other surface coatings.
14. Gelcoat discoloration, blisters or bubbles, including, but not limited, to those which may result from a boat being left in the water for long periods of time.
15. Upholstery cracks, mildew, stains or tears resulting from owner use, lack of maintenance, improper maintenance, impact, misuse, negligence, delay in repair, use of improper cleaners or conditioners.
16. Gelcoat limited warranty is not transferable to second owner and its duration is limited to one (1) year from the original purchase date.
17. Any boat purchased from a dealer in another country, where the primary use of the boat will require the boat to cross an international border, except to the extent otherwise expressly provided in a separate written agreement between the First Owner and Skier's Choice.
18. Skier's Choice reserves the right to improve its products through changes in design or material without being obligated to incorporate such changes in products of prior manufacture.

## OTHER LIMITATIONS

1. THIS LIMITED WARRANTY LIMITS THE DURATION OF ANY IMPLIED WARRANTY OF MERCHANTABILITY OR IMPLIED WARRANTY OF FITNESS FOR A PARTICULAR PURPOSE TO THE PERIODS SPECIFIED HEREIN. Some states do not allow limitations on how long an Implied Warranty lasts, so this limitation may not apply to you.
2. THE REMEDIES OF REPAIR OR REPLACEMENT AT THE OPTION OF SKIER'S CHOICE, AS SET FORTH HEREIN, ARE THE ONLY REMEDIES AVAILABLE UNDER THIS WARRANTY. SKIER'S CHOICE DISCLAIMS ANY OBLIGATION OR LIABILITY FOR COSTS OR CHARGES DERIVED FROM INCONVENIENCE OF LOSS OF USE, COMMERCIAL OR MONETARY LOSS DUE TO LOSS OF TIME, INCONVENIENCE, OR ANY OTHER CONSEQUENTIAL, SPECIAL OR INCIDENTAL DAMAGES. Some states do not allow the exclusion or limitation of incidental or consequential damages, so the above limitations or exclusions may not apply to you.
3. THIS WARRANTY IS IN PLACE OF ANY OTHER EXPRESS WARRANTIES.
4. THIS WARRANTY APPLIES TO THE FIRST OWNER. Unless the warranty was properly transferred to a second owner.
5. THIS WARRANTY GIVES YOU SPECIFIC LEGAL RIGHTS, AND YOU MAY ALSO HAVE OTHER RIGHTS WHICH VARY FROM STATE TO STATE.
6. THIS WARRANTY IS EXPRESSLY IN LIEU OF ANY CONTRACTUAL LIABILITIES, INCLUDING PRODUCT LIABILITIES.
7. THE DEALER IS NOT THE AGENT OF SKIER'S CHOICE AND SKIER'S CHOICE DOES NOT AUTHORIZE THE DEALER, OR ANY OTHER PERSON, TO ASSUME ON BEHALF OF SKIER'S CHOICE ANY LIABILITY OR EXPENSE INCURRED IN THE COURSE OF REPAIRING ITS PRODUCTS OTHER THAN THOSE EXPRESSLY AUTHORIZED IN THIS LIMITED WARRANTY. THE DEALER MAY NOT EXTEND OR IN ANY WAY CHANGE OR AMEND THIS LIMITED WARRANTY .

## OWNER'S RESPONSIBILITY

1. Before operating your Moomba, it is necessary to read and fully understand this Owner's Manual and all other information delivered with the boat.
2. It is the owner's responsibility to take the boat to an authorized Moomba dealer to obtain warranty service.
3. It is the owner's responsibility to properly operate and maintain the boat in accordance with this manual and all other information delivered with the boat.
4. The owner should keep maintenance records should it be necessary to show that required maintenance has been performed on the boat.

## DEALER'S RESPONSIBILITY

1. The Dealer should provide the buyer with an adequate orientation in the general operation of the boat and review all systems and accessories included with the boat.
2. The Dealer should deliver a complete owner's manual packet with the boat consisting of Owner's Manual, Registration, Engine Manual, Stereo Manual, Moomba Warranty and all warranties for separately warranted items aboard the boat.
3. The Dealer should review all warranty information with the buyer and assist in filling out warranty cards if necessary.
4. The Dealer should ensure that any information or obligation from either Skier's Choice, Inc. or from the dealership is clearly understood by the buyer.
5. The Dealer should instruct the buyer in obtaining local service and out-of-area service for a Moomba boat.

## CUSTOMER ASSISTANCE

The staff at Skier's Choice, Inc. is concerned with your complete satisfaction. This includes the prompt resolution of any problems that may arise during the warranty period. Normally, problems encountered may be efficiently and effectively resolved by your Moomba Dealer. However, if a problem cannot be handled by the Dealer or if a solution is not satisfactory to you as an Owner, please follow these steps to get the matter resolved:

### STEP ONE

Discuss the problem with a member of your Moomba Dealer's management staff. It is most likely that the problem will be resolved at this level.

### STEP TWO

If the Dealer management does not resolve the problem to your satisfaction, please have the problem and all action taken, documented by the Dealer, then contact the factory Customer Service Representative at Skier's Choice, Inc.

**Skier's Choice, Inc.**  
**1717 Henry G. Lane Street**  
**Maryville, TN 37801**  
**Tel: (865) 983-9924**  
**Fax: (865) 983-9950**

Describe the original problem in detail to the Customer Service Representative. Be prepared to furnish appropriate documentation and the reasons why service by the Dealer was unsatisfactory. If further action is required to resolve the problem, the Customer Service Representative will dictate the appropriate action.

### STEP THREE

Finally, if after following these steps and providing documentation and after obtaining necessary authorization from the Customer Service Representative to take additional action, the problem is still not resolved to your satisfaction, the President of Skier's Choice, Inc. will personally review the problem and make a determination concerning final resolution.



<b>A</b>			
Accessory Power Switch		35-36	
<b>B</b>			
Battery & Cable Installation		68	
Battery Box		50	
Battery - (Optional Dual Hookup)		61	
Battery Specifications		73	
Ballast System (Optional)		39-41	
Bilge Area Drain Plug		27	
Bilge Pump Switch		35-36	
Bimini Top (Optional)		53	
Blower Switch		35-36	
Boating Rules		17-19	
Boating Safety		5	
Boat Specifications		21-22	
Bow Eye		48	
Bow Filler Cushion		59	
Bow Light		47	
Break-In		23	
<b>C</b>			
Canvas Cover		24	
CD Changer (Optional)		58	
Cleaning Care		70	
Cleats		47	
Coast Guard Regulations		15	
Cockpit Cover (Optional)		58	
Cooler		54	
Cooling Systems		57, 64	
Customer Assistance		83	
<b>D</b>			
Daily Checklist		4	
Dealer's Responsibilities		83	
Depth Sounder		32-33	
Digital Cruise Control		34, 55-56	
Double-Up Seating		53	
Drain Plug Bilge Area		27	
Drain Plug Center-V-Drive		27	
Drain Plug Rear		27	
Driver's Seat		44	
<b>E</b>			
Electrical Replacements (Bulbs & Fuses)		74	
Emergency Procedures		13	
Engine Check Light		38	
Engine Data		73	
Engine Hour Gauge		30	
Engine Hours		30	
Engine Warm-Up		25	
<b>F</b>			
Fiberglass Care		69	
Filling Fuel Tank		28	
Fire Extinguisher		45	
Fire Suppression System		59	
Fresh Water Flush		57	
Foreign Material Deposits		70	
Fuel		28	
<b>F (continued)</b>			
Fuel Cap		28, 43	
Fuel Gauge		30	
Fuel Information		51	
Fuel Precautions		28	
Fuel Tank Pump & Filter		52	
Fuel Vent		51	
<b>G</b>			
Glove Box		45	
<b>H</b>			
Heater (Optional)		60	
Hoisting		72	
Horn		37	
Hull Identification Number		73	
Hull Protection		70	
<b>I</b>			
Ignition		37	
Ignition Key		43	
Instrument Panel & Controls		29	
Introduction		3	
<b>J</b>			
<b>K</b>			
<b>L</b>			
Lifting Rings		48	
Lights, Courtesy		54	
Lights, Docking		59	
Lubrication - Body		64	
<b>M</b>			
Maintenance Chart		64	
Maximum Capacities		24	
Mirror		43	
Motor Box Cover		44	
<b>N</b>			
Navigation Lights		35-36	
Neutral Lock Out		26	
<b>O</b>			
Oil Dipstick		65	
Oil Level Check		65	
Oil Pressure Gauge		31	
Oil Specifications		65	
Operating Instructions		23, 25	
Outback Hi-Low Rear Seat		49	
<b>P</b>			
Pole Light Receptacle		47	
Propeller		49	
Propeller Precaution		49, 67	

(Continued Next Page)

**INDEX (CONTINUED)****P (continued)**

Pulley & Belt Warning	44
Pylon - Swivel (Optional)	59

**R**

Rad-A-Cage	46
Rear Drain Plug	27
Rub Rail Care	69

**S**

Safety Lanyard/Engine Shut-Off	38
Safety Procedures	5-9
Satellite Radio (Optional)	54
Seat Adjustment	44
Service & Maintenance	63
Shaft - Dripless Seal	66
Ski Platform	48
Ski Pylon	45
Slalom Course Speeds	29
Speedometer	30
Speed Calibration	29
Speedometer Paddle Wheel (Pickups)	30
Starting & Operation	25
Stern Light	47
Stereo	34
Stereo Switch	35-36
Stereo Remote - Transom (Optional)	59
Stereo Amp (Optional)	58
Subwoofer (Optional)	57
Summerization	71

**T**

Tachometer	30
Technical Information	73
Teakwood Care	70
Temperature Gauge	31
Throttle Lever	26
Tilt Steering	37
Tonneau Cover (Optional)	58
Tower Pole Light	47
Tower Speakers (Optional)	57
Tower Speakers & Light Bar (Optional)	58
Tower-V2	46
Trailer	75-79
Boat Hook Up	75
Loading Procedure	76
Trailer Alignment	77
Unloading Procedure	76
Transmission	66
Fluid Level Check	67
Fluid Specifications	66, 67
Transmission Lockout Button	26
Trim Switch & Gauge (Optional)	50

**U**

Upholstery Care	70
-----------------	----

**V**

V-Drive	
Change Frequency	66
Engine Compartment	44
Fluid Check	67
Maintaining Fluid Level	67
Location	67
Remote Oil Filter	65
Warning Light	38
Voltmeter	31

**W**

Wakeboard Racks (Optional)	53
Wakeplate	50
Walk-Thru Windshield	51
Warning Plates & Labels	10-11
Warning Light	38
Warranty Information	81-83
Washing Boat	69
Water Strainer (Optional)	60
Wet Slipping Boots	70
Windshield Care	69
Winterization & Dry Storage	71

## Watersports Responsibility Code

Be aware that there are elements of risk in boating, skiing, and riding that common sense and personal awareness can help reduce. Know your ability level and stay within it.

To increase your enjoyment of the sport follow the "Watersports Responsibility Code".

It is your responsibility to:

- Familiarize yourself with all applicable laws, the risks inherent in the sport, and the proper use of equipment.
- Know the waterways where you will be skiing or riding. Do not ski or ride in shallow water, near shore, docks, pilings, swimmers, or other watercraft.
- Always have a person other than the boat driver as an observer and agree on hand signals before starting.
- Always wear a U.S. Coast Guard type III (PFD) vest.
- Read your owner's manual and inspect your equipment prior to use.
- Ski or ride within your limits. Always ski or ride in control and at speeds appropriate for you ability.
- Always turn ignition off when anyone is near watercraft power drive unit.
- Carbon Monoxide (CO) poisoning from engine exhaust may cause injury or death. Never "Platform Drag" or touch a swim platform while the engine is running.
- Do not operate watercraft, ski or ride under the influence of alcohol or drugs.



*Water Sports Industry Association*











